

**Vibration Control System**

**K2  
K2Sprint**

**Common Part TYPE II  
Instruction Manual**

**IMV CORPORATION**

Type of Document : Instruction Manual

System Applied : K2/K2Sprint

Application Software later than Version 20.2.0

Device Driver later than Version 11.1.0

Note) If the hardware used is the old type system, its specifications conform to those of the old type system.

English Edition

Version	Date	Contents
11.0.0	2013.11.29	First edition
11.0.1	2014.01.18	Correction of required computer environment
11.1.0	2014.12.05	Additional description of initial setting of 3D graph(Waterfall graph and Color map), modified description of Print
12.0.0	2015.03.02	Complete revision of “Installation and system startup”, modified description of ”Startup and finishing of application”, additional description of auxiliary information display in graph
12.2.0	2015.10.30	Additional description of Quick Report, correction of misprints
12.3.0	2016.01.25	Addition of IEPE sensor stabilization waiting function, addition of requirements for PC
13.0.0	2016.04.28	Applied to Windows10, modified description of requirements for PC, additional description of Launcher
13.1.0	2016.07.29	Additional description of toolbar button customizing function, applied ‘Graph display function on Excel’ to Excel2016, applied ‘Report Generator’ to Word2016, correction of misprints
13.2.0	2016.10.31	Modified description of ” Installation of Application”, correction of misprints
13.3.0	2017.03.01	Correction of misprints
13.6.0	2017.10.02	Additional description of Viewer (function to restore the display configuration, overlaid graph file selection method), additional description of automatic adjustment of legend length
13.6.1	2017.10.18	Correction of misprints
13.6.2	2017.12.20	Additional description of specification in English units(inch-pound units), correction of misprints
14.1.0	2018.04.27	Additional description of German version, pallet tool icon and graph tool icon, E-Mail sending function, correction of misprints
14.2.0	2018.09.10	Additional description of function to mark cursor data
14.2.1	2018.12.06	Add DVD-ROM as the recording media for installers
14.3.0	2019.04.19	Modified description of excitation system information, modified description of Launcher operating setting, additional description of Calibration, correction of misprints
14.4.0	2019.09.20	Addition of intended use judgment function, addition of test record, additional description of Contact input signal (Skipping to the beginning of the next sweep / Skipping to the first spot) ,modified description of requirements for PC, applied ‘Graph display function on Excel’ to Excel2019, applied ‘Report Generator’ to Word2019, correction of misprints
14.6.0	2020.04.15	Modified description of intended use judgment function,

Version	Date	Contents
20.0.0	2020.11.02	Modified description of installation, uninstallation and update of software, change of supported OS
20.1.0	2021.01.28	Additional description of Overlaid graph of two types of data and the contact output [LEVEL CHANGE] of Random
20.2.0	2021.03.18	Additional description of Launcher settings menus and the field coil current control at the low frequency of ISM. Changed the description of Chapter 8 from Calibration to Condition Check.

# CONTENTS

Chapter 1	System Configuration.....	1-1
1.1	Hardware Configuration .....	1-1
1.1.1	Computer .....	1-1
1.1.2	Dedicated Hardware I/O Unit .....	1-3
1.2	Hardware Specifications .....	1-4
1.2.1	Specifications .....	1-4
1.2.2	Dedicated Hardware .....	1-9
1.3	Software Configuration .....	1-12
1.3.1	OS.....	1-12
1.3.2	Application Software .....	1-12
Chapter 2	System Set Up.....	2-1
2.1	Installation .....	2-1
2.1.1	Environment for Installation .....	2-1
2.1.2	Installation of K2 Interface Board .....	2-1
2.1.3	Connection to PC .....	2-2
2.1.4	Connection to Excitation System .....	2-2
2.2	Installation, Uninstallation and Update of Software.....	2-2
2.3	Other Settings .....	2-3
2.3.1	Emergency Stop Input Contact .....	2-3
2.3.2	Changing of Input Mode .....	2-4
2.3.3	ID Setting for Each Module .....	2-4
2.4	Startup and Stopping of System .....	2-5
2.4.1	Startup of System .....	2-5
2.4.2	Stopping of System .....	2-5
Chapter 3	Setting of K2 System.....	3-1
3.1	Environment Setting .....	3-1
3.2	I/O Module Configuration .....	3-1
3.3	Excitation Information .....	3-2
3.3.1	Excitation System Information name .....	3-2
3.3.2	Drive Output .....	3-2
3.3.3	Polarity .....	3-2
3.3.4	Initial Output Voltage Default Value .....	3-3
3.3.5	Rating Information .....	3-3
3.3.5.1	Load from system model.....	3-3
3.3.6	Control Frequency Range is limited .....	3-3
3.3.7	Other Control Quantities .....	3-3
3.3.8	Contact I/O .....	3-3
3.3.9	Armature mass .....	3-4

3.4	Input Channel Information.....	3-5
3.4.1	Input Environment Information Name.....	3-5
3.4.2	Name (Channel Name).....	3-5
3.4.3	Module / Ch. ....	3-6
3.4.4	Quantities.....	3-6
3.4.5	Input Type.....	3-6
3.4.6	Sensitivity.....	3-6
3.4.7	Polarity.....	3-7
3.4.8	TEDS Access.....	3-7
Chapter 4	Fundamental Operation Method .....	4-1
4.1	Outline.....	4-1
4.2	Fundamental Operation.....	4-2
4.2.1	Application Start Up.....	4-2
4.2.2	Exit from Application.....	4-3
4.2.3	Description of Icons.....	4-5
4.2.4	File Operation.....	4-8
4.2.4.1	File Open.....	4-8
4.2.4.2	Save As.....	4-9
4.2.5	Add a Page.....	4-10
4.2.6	Palette Operation.....	4-12
4.2.6.1	Palette Tool Icons.....	4-12
4.2.6.2	Moving the Palette.....	4-13
4.2.7	Other Operations.....	4-14
4.2.7.1	Set Up.....	4-14
4.2.7.2	Operation Status.....	4-15
4.2.7.3	Manual Operation.....	4-15
4.3	Graph Operation.....	4-16
4.3.1	Graph Tool Icons.....	4-16
4.3.2	Selecting of Graph Display.....	4-17
4.3.2.1	Selecting of 3D graph.....	4-19
4.3.3	Scale.....	4-25
4.3.3.1	3D graph scale change.....	4-27
4.3.4	Cursor Display.....	4-28
4.3.4.1	Double cursor display.....	4-29
4.3.4.2	Peak search.....	4-30
4.3.4.3	Registration of cursor data.....	4-31
4.3.4.4	Cursor display in 3D graph.....	4-33
4.3.5	Graph Change.....	4-34
4.3.6	Peak Mark.....	4-35
4.3.7	Graph Color Setting.....	4-36

4.3.7.1	Change Graph Color .....	4-36
4.3.7.2	Change of Auxiliary Information .....	4-37
4.3.7.2.1	Test Beginning/Ending Time .....	4-37
4.3.7.2.2	Peak Mark .....	4-38
4.3.7.2.3	Legend Width .....	4-38
4.3.8	Overlaid graph of two types of data .....	4-39
4.4	Output to the Printer .....	4-42
4.4.1	Print .....	4-42
4.4.2	Printer Setting .....	4-44
4.4.3	Page setup .....	4-45
4.4.4	Print Color Setting .....	4-46
4.5	File Conversion .....	4-48
4.5.1	File conversion to CSV .....	4-48
4.5.2	Graph display on Excel .....	4-51
4.6	Selecting languages (option) .....	4-52
4.7	Test Definition File .....	4-53
4.7.1	Saving Live Data in Operation .....	4-53
4.7.2	Deleting of Testing Operation Relational Data .....	4-54
4.7.3	Another Excitation System Information loading .....	4-56
4.7.4	Input Environment Information .....	4-58
4.7.5	New Input Environment Information Loading .....	4-58
4.7.6	New Input Environment Information Saving .....	4-59
4.8	Contact I/O Information .....	4-60
4.8.1	Outline .....	4-60
4.8.2	Contact I/O setting .....	4-61
4.8.3	Contact I/O signal Setting .....	4-64
4.9	IT Function .....	4-69
4.9.1	Web Monitor .....	4-69
4.9.2	E-Mail Sending Function .....	4-72
4.9.3	Report Generator (Auto-generating function of the testing result report)...	4-76
4.9.4	Quick Report .....	4-87
4.10	Waiting for Stabilization of IEPE Sensor .....	4-90
4.11	Customizing Toolbar Buttons .....	4-91
Chapter 5	Energy-saving operation: ECO-option (ISM) .....	5-1
5.1	Outline .....	5-1
5.2	Constraints in operation .....	5-1
5.2.1	Constraints in SINE .....	5-1
5.2.2	Constraints in RANDOM .....	5-2
5.3	(This section is left blank intentionally.) .....	5-3
5.4	Settings for ECO-option .....	5-4

5.4.1	Initial setting (factory setting).....	5-6
Chapter 6	Data Viewer .....	6-1
6.1	Outline.....	6-1
6.2	Operation example .....	6-3
6.2.1	Description of Icons.....	6-3
6.2.2	Display of Standard Graph.....	6-5
6.2.3	Display of Overlaid Graph.....	6-7
6.2.3.1	Select on Tree Display.....	6-7
6.2.3.2	Select on Dialogue Display.....	6-11
6.2.4	Display of 3D graph.....	6-16
6.3	Supplemental Explanation .....	6-21
6.3.1	Set Up.....	6-21
Chapter 7	Launcher .....	7-1
7.1	Outline.....	7-1
7.1.1	Precautions for 'Standards' Mode and 'Test Files' Mode .....	7-2
7.1.1.1	Preparation.....	7-2
7.1.1.2	Change of Excitation System Information.....	7-2
7.1.1.3	Limit of Control Channel.....	7-2
7.2	Operation Example .....	7-3
7.2.1	'Applications' mode .....	7-3
7.2.2	'Standards' Mode .....	7-6
7.2.3	'Test files' mode .....	7-11
7.3.	Supplementary Explanation.....	7-16
7.3.1	Registration and Deletion of Standard Items .....	7-16
7.3.1.1	Registration of Test Files as Standards.....	7-16
7.3.1.2	Deletion of Registered Standards.....	7-19
7.3.2	Supplementary Explanation of Standards Mode .....	7-20
7.3.2.1	Contents Displayed on Screen.....	7-20
7.3.2.2	Finding of Standards.....	7-21
7.3.2.3	Test summary Information Registered in Saved Test File.....	7-23
7.3.2.4	Setting of control channel.....	7-24
7.3.2.4.1	Use the original sensitivity of input environment information.	7-24
7.3.2.4.2	Modify the sensitivity of input environment information.....	7-24
7.3.3	Supplementary Explanation of Test Files Mode .....	7-25
7.3.3.1	Folder.....	7-25
7.3.3.1.1	Contents Displayed on Screen .....	7-25
7.3.3.1.2	Test summary Information Registered to Saved Test File.....	7-26
7.3.3.2	History.....	7-27
7.3.3.2.1	Contents Displayed on Screen .....	7-27
7.3.3.2.2	Test summary Information Registered to Saved Test File.....	7-27



7.3.3.3 Favorite.....	7-28
7.3.3.3.1 Contents Displayed on Screen.....	7-28
7.3.3.3.2 Test summary Information Registered to Saved Test File.....	7-28
7.3.3.4 Setting of control channel.....	7-29
7.3.3.4.1 Use the original setting of the selected test file without modification.....	7-29
7.3.3.4.2 Modify the setting of the selected test file.....	7-29
7.3.3.4.3 Use the top information of the input environment information list.....	7-30
7.3.4 Quick Help.....	7-31
7.3.5 Operating Setting.....	7-33
7.3.5.1 Setting Procedures.....	7-33
7.3.5.2 Setting Item.....	7-34
7.3.6 Application auto-start settings.....	7-35
Chapter 8 Condition Check.....	8-1
8.1 Outline.....	8-1
8.2 Examples of operations.....	8-3
8.2.1 Constant voltage characteristics measurement.....	8-3
8.2.2 Voltage input sensitivity inspection.....	8-8
8.2.3 Charge input sensitivity inspection.....	8-10
8.2.4 Simplified diagnosis of the excitation system.....	8-12
8.2.5 Supplementary functions.....	8-15
Chapter 9 Intended Use Judgment Function.....	9-1
9.1 Outline.....	9-1
9.2 Operation Example.....	9-2
9.2.1 Procedures.....	9-2
Chapter 10 Test Record.....	10-1
10.1 Outline.....	10-1
10.2 Operation Example.....	10-2
10.2.1 Startup.....	10-2
10.2.2 Operation on Screen.....	10-3
10.2.3 Other Operations.....	10-4
10.3 Option.....	10-5
10.3.1 Set Up.....	10-5
10.3.2 SecuritySetting.....	10-6
10.3.3 Selection of Column.....	10-6

# Chapter 1 System Configuration

## 1.1 Hardware Configuration

### 1.1.1 Computer

① Model to be used

IBM PC/AT (or complete compatible systems) with a PCI Express x1 expansion slot.

② Requirements

- One available expansion slot

PCI Express x1 slot

- Windows 10 Pro(64bit), Windows 10 IoT Enterprise(64bit) or Windows 7 Professional SP1(64bit) loaded\*

- Main memory in the PC (for the system having up to 8 input channels)\*

More than 4GB

- 10GB or more available hard disk space

- CD/DVD-ROM Drive loaded (necessary at installation)

- One USB port (necessary for protect device)

- For Eco shaker

- .Net Framework 4.6.1 has been installed (operation is not guaranteed with any other than this version.)

- One Built-in RS-232C port ( 9 pin D-sub connector )

Usage of an USB port via ‘USB to RS-232C serial converter’ is not allowed.

\* Recommended OS and main memory varies depending on software, option and the number of input channels etc.

Example)

- When the optional software SHOCK/MEGA POINT is installed

- For the system having up to 4 input channels

More than 4GB

- For the system having over 5 input channels

More than 8GB

- When Multi-degree-of-freedom vibration control system is installed

More than 8GB

< Construction in Standard Use >

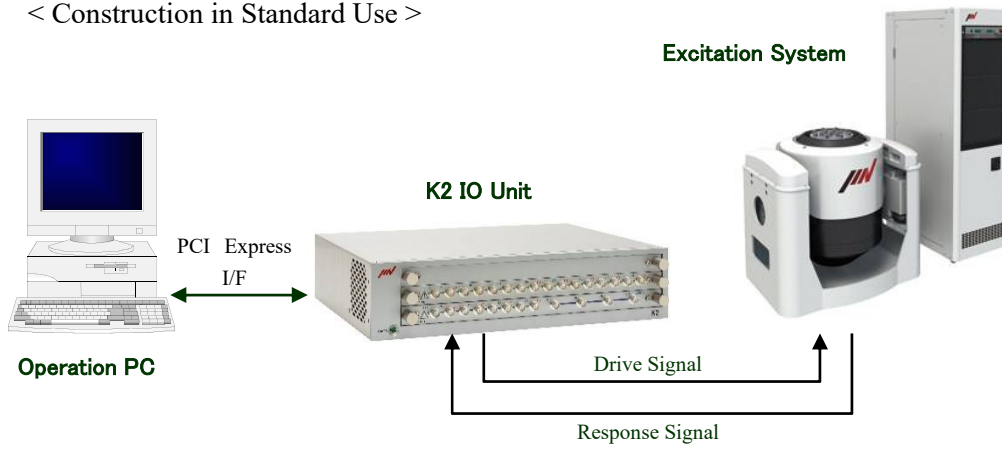

### 1.1.2 Dedicated Hardware I/O Unit

#### 1) Standard Configuration (Number of Response Inputs : 4)

① Small Cabinet	K2ST-11-011	x 1
② Input/Output Module	K2ST-23-011	x 1
③ PC I/F Kit (with 1.5m[4.9ft] cable)	K2ST-34-011	x 1

Multiple cabinets are necessary when the input channels are increased. In this case, each cabinet is connected by using the small cabinets, K2ST-11-011

#### 2) K2Sprint I/O Unit(Number of Response Inputs : 2)

① Cabinet (with 2 inputs, 2 outputs module)	K2SP-11-011	x 1
Accessories	AC Adapter	x 1
② PC I/F Kit (with 1.5m[4.9ft] cable)	K2ST-34-011	x 1

K2Sprint I/O Unit is a hardware bundle in which the dedicated hardware having only two input/output channels and PC I/F Kit are packaged. No channel can be added in K2Sprint I/O Unit.

## 1.2 Hardware Specifications

### 1.2.1 Specifications

#### Control Signal Input Part

- (1) Number of Channels : 4+8xn [2 for K2Sprint I/O Unit] (simultaneous sampling)
- (2) Input Terminal : BNC
- (3) Input Format : Charge, Voltage, IEPE
- (4) Charge Amplifier Sensitivity : 1.0 mV/pC or 10 mV/pC
- (5) Cut-off of Charge Amplifier : 0.32 Hz
- (6) Maximum Input : at Charge (1.0 mV/pC) input  $\pm 10000$  pC  
 at Charge (10 mV/pC) input  $\pm 1000$  pC  
 at Voltage input  $\pm 10000$  mV  
 at IEPE input  $\pm 10000$  mV

#### Maximum input of Acquisition unit conversion

Input format	Max. input (acquisition unit)
Charge (1.0 mV/pC)	10000/A
Charge (10 mV/pC)	1000/A
Voltage input	10000/A
IEPE input	10000/A

(A : Sensor sensitivity [mV/acquisition unit] or [pC/acquisition unit])

- (7) Sampling Frequency : Maximum 51.2 kHz
- (8) Coupling : AC or DC
- (9) Cut-off at AC Coupling : 0.1Hz
- (10) CCLD at IEPE : +24V DC, 3.5mA
- (11) TEDS at IEPE : Available (Ver0.9, Ver1.0)
- (12) A/D Converter : Method  $\Delta \Sigma$  method  
 Resolution 24-bit  
 Dynamic range 117 dB  
 Digital filter Ripple in pass band  $\pm 0.001$  dB  
 Rejection band attenuation quantity 110 dB
- (13) Frequency Characteristics : at Charge input(1.0 mV/pC)  
 within  $\pm 0.1$ dB 1 kHz  
 at Voltage input  
 within  $\pm 0.1$ dB 1 kHz

### Control Signal Output Part

- (1) Number of Channels : 4 [2 for K2Sprint I/O Unit]  
(one of these channels is used as drive output)
- (2) Output Terminal : BNC
- (3) Output Format : Voltage
- (4) Maximum Output :  $\pm 10\,000$  mV
- (5) Sampling Frequency : Maximum 51.2 kHz
- (6) D/A Converter : Method  $\Delta \Sigma$  method  
Resolution 24-bit  
Dynamic range 120 dB  
Digital filter Ripple in pass band  $\pm 0.005$  dB  
Rejection band attenuation quantity 75 dB

## External Input/Output Part

### Remote Control Contact Input/Output Ports

- Connector : 50-pole ribbon connector (female)  
 Parts used DDK 57RE-40500-730B(D29)-FA
- Input : Isolated input 8-bit by photo coupler  
 Minimum current 3mA  
 Maximum current 50mA
- Output : Relay output 8-bit at each A contact and B contact  
 Maximum current DC 1A (30V)  
 AC 0.5A (125V)

25	24	23	22	21	20	19	18	17	16	15	14	13	12	11	10	9	8	7	6	5	4	3	2	1
STOP+	O8A	O7A	O6A	O5A	O4A	O3A	O2A	O1A	O8B	O7B	O6B	O5B	O4B	O3B	O2B	O1B	I8-	I7-	I6-	I5-	I4-	I3-	I2-	I1-
STOP-	O8A	O7A	O6A	O5A	O4A	O3A	O2A	O1A	O8B	O7B	O6B	O5B	O4B	O3B	O2B	O1B	I8+	I7+	I6+	I5+	I4+	I3+	I2+	I1+
50	49	48	47	46	45	44	43	42	41	40	39	38	37	36	35	34	33	32	31	30	29	28	27	26

Connector Pin Configuration (Remote Control Contact I/O Ports)

### Input Circuit

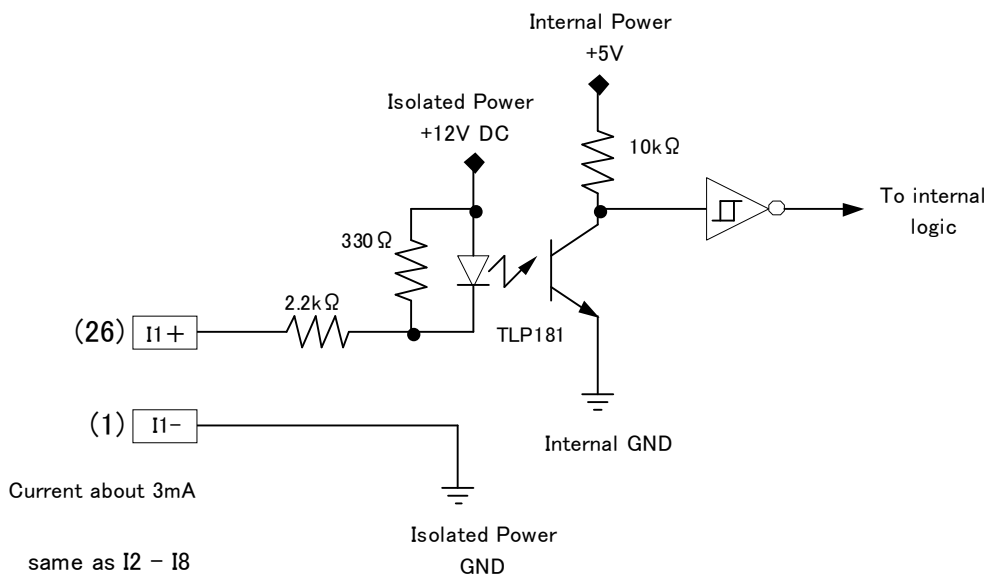

## Output Circuit

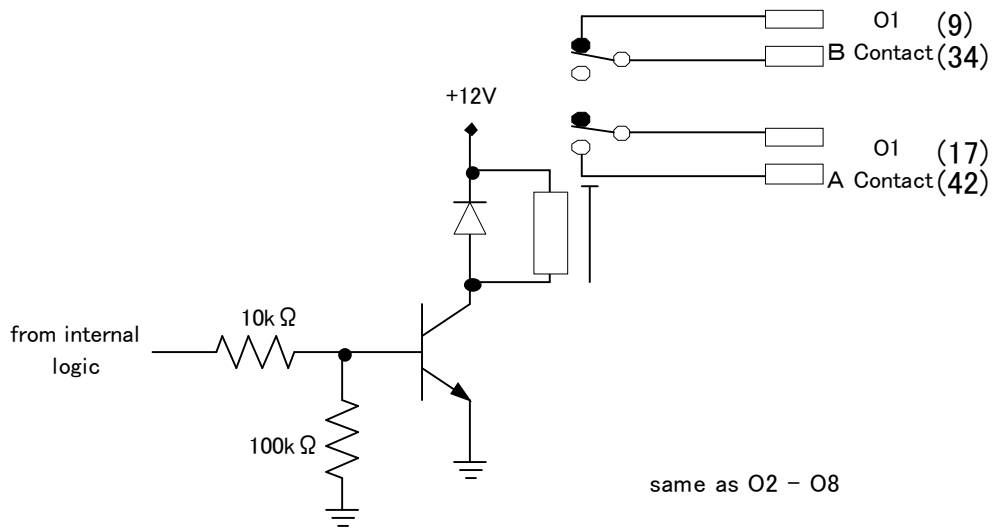

## Emergency Stop Input Contacts

These contacts are for setting the drive output to zero compulsorily at emergency without using the software. 25 pin and 50 pin of Remote Control Contact I/O connector pins are used as Emergency Stop Input Contacts.

The function of the drive output stop is realized by using the mute function of D/A converter and reduce the drive output with taking the time of 1024 sampling interval.

Canceling and switching the polarity of Emergency Stop Function are done by DIP switch.

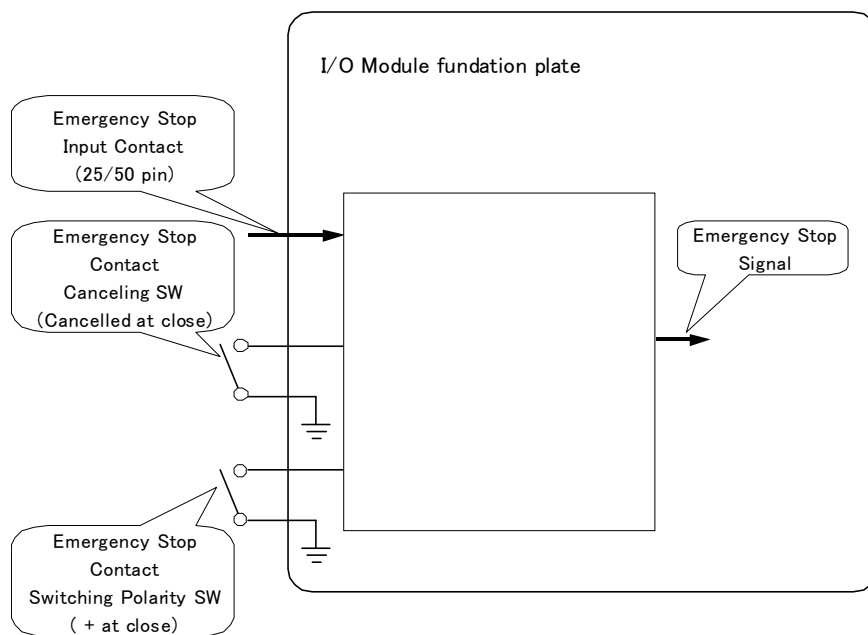



## Cabinet and General Specifications

Following description is about a small cabinet

- (1) Ambient temperature for operation : 0 ~ 40°C [32 ~ 104° F]
- (2) Ambient humidity for operation : Not higher than 85% without dew condensation
- (3) Altitude for operation : 2000m [6561.7ft] or lower
- (4) Ambient temperature for transport/storage : -10 ~ 55°C [14 ~ 131° F]
- (5) Input power rating : AC100-240V, 50/60Hz, 0.5A
- (6) Allowable input voltage range : +10%, -10%
- (7) Number of slots : 3 (possible to increase by connecting cabinets)
- (8) Extension Function : Cabinet – Cabinet connection function  
(Supporting for Large-Scale System)
- (9) Emergency Stop Function : Available to set to ON/OFF and input polarity
- (10) External Communication Function : Contact I/O : Input x 8, Output x 8
- (11) Size : 430(W) × 340(D) × 100(H) mm  
[16.9(W) × 13.4 (D) × 3.9 (H) in]  
(not including the projection parts)
- (12) Weight : about 6.0 kg [13.2lbs]

Following description is about K2Sprint I/O Unit

- (1) Ambient temperature for operation : 0 ~ 40°C [32 ~ 104° F]
- (2) Ambient humidity for operation : Not higher than 85% without dew condensation
- (3) Altitude for operation : 2000m [6561.7ft] or lower
- (4) Ambient temperature for transport/storage : -10 ~ 55°C [14 ~ 131° F]
- (5) Input power rating : DC12V, 1A
- (6) Allowable input voltage range : +10%, -10%
- (7) Number of Input/Output Channels : each 2 channel
- (8) Extension Function : none
- (9) Emergency Stop Function : Available to set to ON/OFF and input polarity
- (10) External Communication Function : Contact I/O : Input x 8, Output x 8
- (11) Size : 345(W) × 210(D) × 40(H) mm  
[13.6(W) × 8.3 (D) × 1.6 (H) in]  
(not including the projection parts)
- (12) Weight : about 2.0 kg [4.4lbs]

## 1.2.2 Dedicated Hardware

### (1) Input/Output Module (K2ST-23-011)

#### <Input>

Analogue signal acquisition by 4 Simultaneous Sampling Input Channels is available.

24 bit D/A converter of  $\Delta \Sigma$  method is used.

The input formats generally supported are Charge Input and IEPE Input besides Voltage Input.

(Voltage Input, Charge Input and IEPE Input are changeable on the software.)

IEPE input supports the TEDS function.

Monitor Output Terminals are provided for every input channel.

#### <Output>

Analogue signal output including the excitation control drive signal for 4 Output Channel is available.

24 bit D/A converter of  $\Delta \Sigma$  method is used.

#### <Common Items>

Maximum Sampling Frequency is 51.2 [kHz].

Each Input/Output circuit is protected by the relay device.

Remote Control Contact I/O function is available as a communication function to external equipments.



(2) Input Module (K2ST-23-012)

Analogue signal acquisition for 8 Simultaneous Sampling Input Channels is available.

24 bit D/A converter of  $\Delta \Sigma$  method is used.

Maximum Sampling Frequency is 51.2 [kHz].

The input formats generally supported are Charge Input and IEPE Input besides Voltage Input.

(Voltage Input, Charge Input and IEPE Input are changeable on the software.)

IEPE input supports the TEDS function.

Monitor Output Terminals are provided for every input channel.

Each input circuit is protected by relay device.



(3) K2Sprint Cabinet (K2SP-11-011)

<Input>

Analogue signal acquisition for 2 Simultaneous Sampling Input Channels is available.

24 bit D/A converter of  $\Delta \Sigma$  method is used.

The input formats generally supported are Charge Input and IEPE Input besides Voltage Input.

(Voltage Input, Charge Input and IEPE Input are changeable on the software.)

IEPE input supports the TEDS function.

Monitor Output Terminals are provided for every input channel.

<Output>

Analogue signal output including the excitation control drive signal for 2 Output Channels is available.

24 bit D/A converter of  $\Delta \Sigma$  method is used.

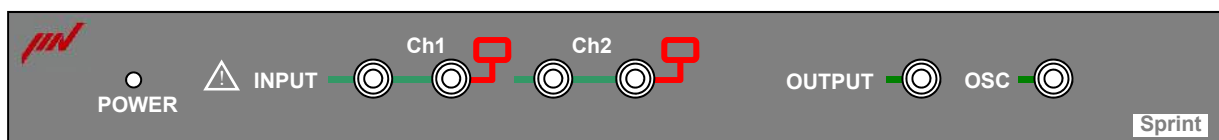

(4) K2 PCI Express I/F Board (K2ST-34-011)

This board is installed at PC/AT (or compatible machine) PCI Express x1 slot and realizes the access to modules of each function for K2.

The PC and K2 I/O Unit are available to connect by using a dedicated cable.

This board has the functions as below ;

- (1) Generation of Sampling Clock
- (2) Real-time waveform data sending / receiving by DMA (bus master)
- (3) Command to the modules of each function for K2 (writing and loading of the register, etc.)
- (4) Observation on the condition of the modules of each function for K2

## 1.3 Software Configuration

### 1.3.1 OS

Microsoft Windows 10 Pro(64bit), Windows 10 IoT Enterprise(64bit) or Windows 7 Professional SP1(64bit).

### 1.3.2 Application Software

(1) SINE

Software for excitation test system on the basis of sinusoidal wave given as data of frequency and excitation level

(2) RANDOM

Software for excitation test system on the basis of reference spectrum specified by PSD

(3) SOR (Sine On Random)

Software for excitation test system on the basis of reference spectrum specified by PSD and sinusoidal wave given as data of frequency and excitation level  
(This software is an optional function which runs on RANDOM)

(4) ROR (Random On Random)

Software for excitation test system on the basis of reference spectrum in a broad and specified by PSD and reference spectrum in a narrow band specified by PSD  
(This software is an optional function which runs on RANDOM)

(5) SHOCK

Software for simultaneous excitation test system on the basis of pulse waveform data specified by each Test Specifications

(6) CAPTURE

Software for measurement system which operates the acquisition of waveform data and PSD Analysis. Acquired / analyzed data is usable as a reference data of RANDOM or SHOCK.

## Chapter 2 System Set Up

### 2.1 Installation

Set up and instruction of I/O unit as a dedicated hardware for K2 system are described as below.

#### 2.1.1 Environment for Installation

Note that the followings to set up the system ;

- ① Not to disturb the air for cooling the machine

Cooling fan of this machine are set on side panel.

Please do not disturb the cooling air by putting things around the machine.

- ② Avoid direct sunlight
- ③ Set the system in fresh air

Refer to “Chapter 1 System Configuration” about the detailed specification for the consumption of electricity / environment of temperature.

#### 2.1.2 Installation of K2 Interface Board

**Be sure to discharge static electricity in your body by touching metal prior to work.**

Turn off the power supply of the PC, and install the K2 PCI Express I/F board into the slot of the PCI Express.

### 2.1.3 Connection to PC

The PC and the K2 I/O Unit must be surely connected.

Type of bus	PC	I/O Unit
K2 dedicated Bus	PC/AT K2 PCI Express I/F Board (K2ST-34-011)	Bus input terminal on the back of K2 cabinet <b>IF IN (right side terminal)</b> <b>or INTERFACE</b>

### 2.1.4 Connection to Excitation System

- ① Input : Signal cables of each pickup set to the shaker are connected to input terminals of front panel of the machine.  
Please pay attention not to mistake the connection with pickups.
- ② Output : Output terminals of front panel of the machine and input terminal of the power amplifier of the excitation system are connected by BNC cables.  
Please pay attention not to mistake the connection with Power Amplifier.

## 2.2 Installation, Uninstallation and Update of Software

Refer to the separate "How to install software" booklet.

### 2.3 Other Settings

The description of items to be set on the other hardware is provided as below. However, you don't have to care about these items very much generally.

#### 2.3.1 Emergency Stop Input Contact

The function of Emergency Stop Input Contact enables to reduce the drive output to zero compulsory (without using the software).

This function can be set to 'ON/OFF', and the setting of 'Contact Polarity' in Emergency Stop operation is also available on the hardware.

Set the contacts using the switches within the cabinet.

Be sure to touch a metal or others to discharge static electricity from your body before setting the contacts.

Pull the power cable out of the cabinet, and then open the cabinet cover.

Set the emergency stop switches on the board.

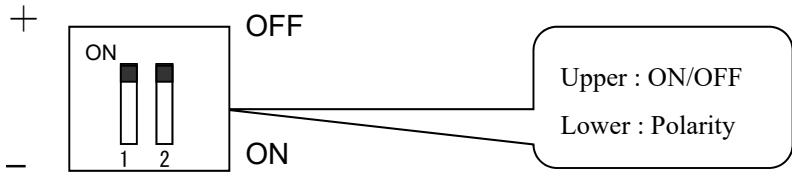

Initial setting of this function is as below ;

ON/OFF OFF  
Polarity +



### 2.3.2 Changing of Input Mode

Three input modes as below are available for input channel of this system.

- (1) Charge input
- (2) Voltage input
- (3) IEPE input

Changing of input is available to operate in each software.

### 2.3.3 ID Setting for Each Module

IDs exist for each module installed to K2 cabinet.

Type of modules are described as below ;

Input/Output Module	K2ST-23-011
Input Module	K2ST-23-012

Note that the followings to set up the ID of each module;

- **Not to set the modules having the same IDs on a system**
- **Set less than 200 value to the module ID**

Set the ID using the 8-bit dip switches on the module board.

Be sure to touch a metal or others to discharge static electricity from your body before setting the ID.

Pull the power cable out of the cabinet and remove the module from the cabinet.

Dip switch ON sets “1”, and OFF, “0”.

For example, the ID setting of the following figure is ‘2’.

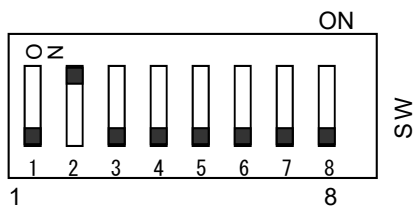

## 2.4 Startup and Stopping of System

General system operating procedures are shown below.

### 2.4.1 Startup of System

< Procedures >

< Step 1 >

After checking that the power supply to the I/O Unit and the power amplifier is not turned on, turn on the power supply to the PC, and then, start up the Windows.

< Step 2 >

After turning on the power supply to the K2 I/O Unit, turn on the power supply to the power amplifier.

< Step 3 >

Start up the application. For the procedures of application startup, refer to “4.2.1 Application Start UP” in Chapter 4.

### 2.4.2 Stopping of System

< Procedures >

< Step 1 >

Finish the application. To finish the application, refer to “4.2.2 Exit from Application” in Chapter 4.

< Step 2 >

After turning off the power supply to the power amplifier, turn off the power supply to the K2 I/O Unit.

< Step 3 >

Finish the Windows, and then, turn off the power supply to the PC.

# Chapter 3 Setting of K2 System

## 3.1 Environment Setting

In Environment Setting, I/O Unit Information, Excitation System Rating Information and the definition information of sensor specifications generally used are defined.

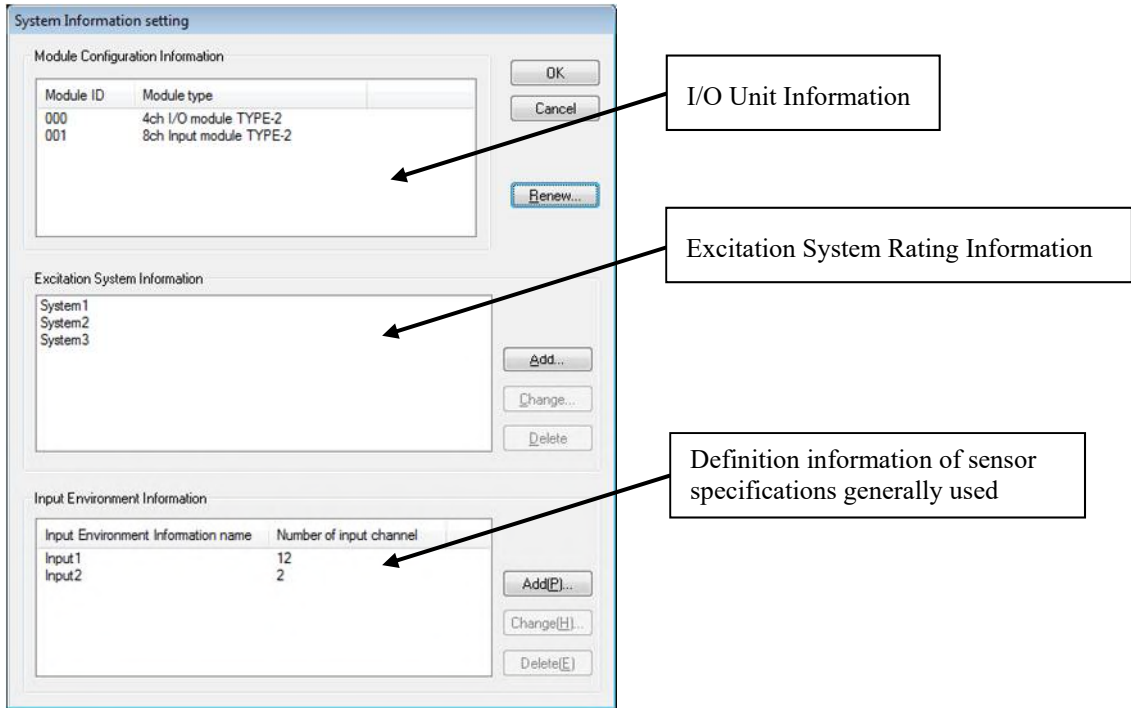

## 3.2 I/O Module Configuration

ID number and the type of I/O Module (Input/output board and Input board) that constructs K2 I/O Unit are displayed.

< I/O Module Configuration change >

The display is to be updated to the latest information by pressing the [**R**enew] button on the right of the list of I/O Module Configuration when the K2 I/O Unit Configuration is changed.

Before renewing the information, I/O Unit should be connected to the current PC by the dedicated cable and power must be turned on.

When the test initialization is impossible to operate after changing the configuration of I/O Unit, execute the command of “Another Excitation System Information loading” process described in Chapter 4.

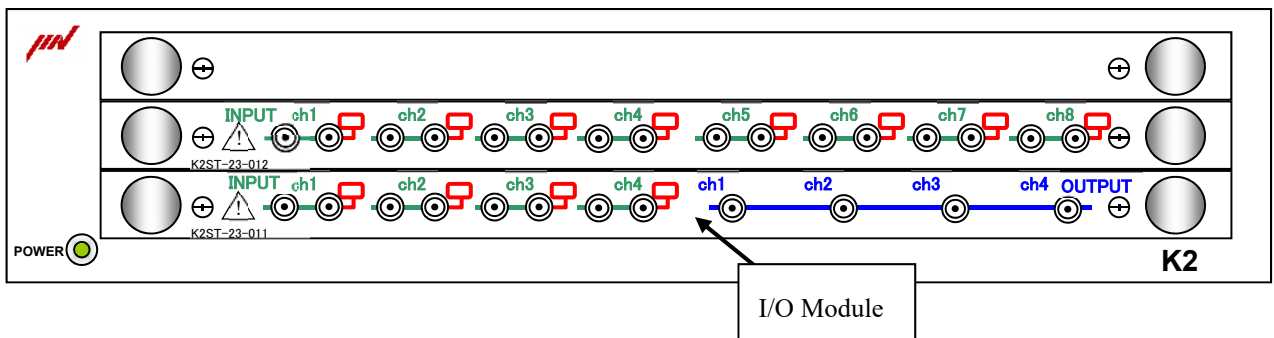

### 3.3 Excitation Information

This item is necessary to be defined.

A defined 'Excitation System Information' is required to be selected when the application of SINE or RANDOM is to be executed.

Mainly, the rating information of the shaker used in Excitation System is registered.

The method of registration is described as below ;

Press the [Add] button on the right of the list displaying Excitation System Information. A dialog for the registration appears.

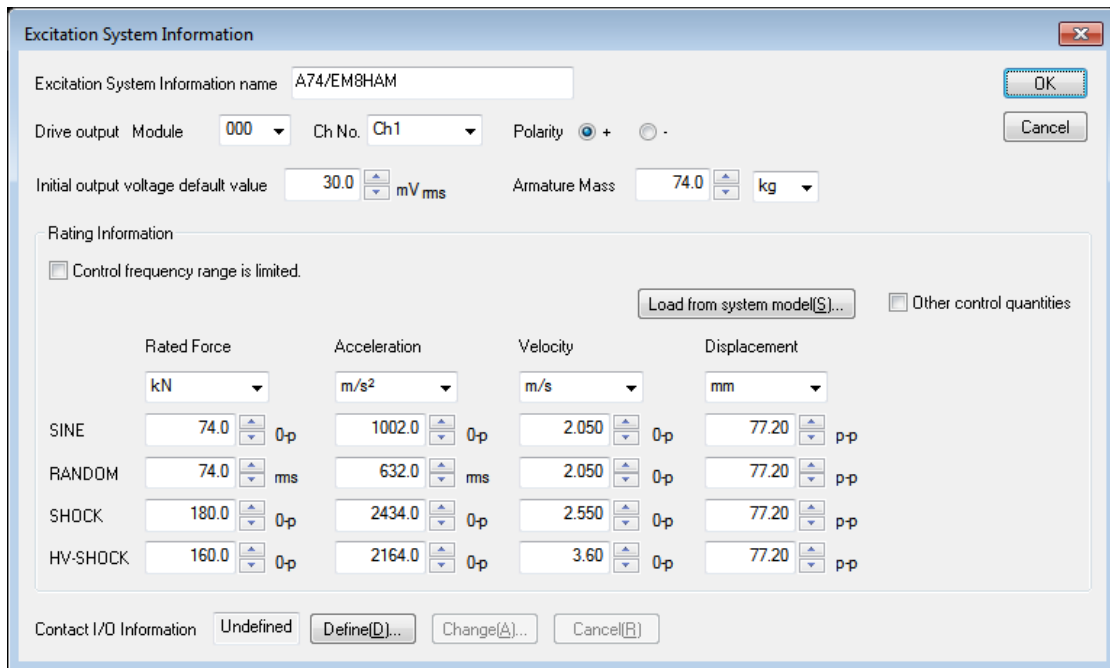

#### 3.3.1 Excitation System Information name

(1) Meaning

This item is for inputting of the registration name of the excitation system (shaker + amplifier) to be used.

#### 3.3.2 Drive Output

(1) Meaning

This item is for specifying of 'Module ID' and 'Ch. (number of output channel)' of I/O Module to be used.

#### 3.3.3 Polarity

(1) Meaning

This item is for setting of the polarity of output channel to be used.

The default value of this item is defined as 'Positive'. The default value is recommended if it is not intended.

When this item is set to 'Negative', the output signal of output channel is treated as that having the negative polarity.

### **3.3.4 Initial Output Voltage Default Value**

(1) Meaning

This item is for setting of a default value for the voltage of the loop check operation at the beginning of control operation.

This default value can be changed in each application.

Please use a suitable value generally for the excitation system to be used.

### **3.3.5 Rating Information**

(1) Meaning

This item is for setting of maximum rating data (Max. Acceleration, Max. Velocity, Max. Displacement) of excitation system to be used.

The rating of excitation system varies according to the characteristics of control signals. So, the specification of this item is for setting the values of each program, such as SINE, RANDOM, SHOCK independently.

‘HV-SHOCK’ is optional.

#### **3.3.5.1 Load from system model**

(1) Meaning

The system rating information is set automatically by selecting a model from the list of excitation systems provided.

### **3.3.6 Control Frequency Range is limited**

(1) Meaning

This item is for setting of the upper and the lower limit of range for the control objective of the excitation system to be used.

When this item is set, the reference having the band out of the range set by this item is controlled in each application.

Please set this item according to the frequency range of the excitation system to be used.

### **3.3.7 Other Control Quantities**

(1) Meaning

This item is for setting of the maximum rating data when the excitation system is to be controlled by other physical quantity than acceleration, velocity and displacement.

### **3.3.8 Contact I/O**

(1) Meaning

This item is for setting of input/output when an external equipment connects with K2 system at a contact in a composite test.

Refer to Contact I/O Information about the setting method.

### **3.3.9 Armature mass**

#### (1) Meaning

This item is for setting of the armature mass of the shaker. The armature mass is used for the excitation force check in the application software, such as SINE.

### 3.4 Input Channel Information

This is not a must item to be defined.

This item is to be set in either methods that selecting an input channel information among the defined information or creating it in each application.

However, it is necessary to be defined beforehand when the function of Simplified Definition is used.

The setting information concerning with the specification of a sensor generally used is registered.

In K2 application, adding and changing of input channel information are available in test definition file creation.

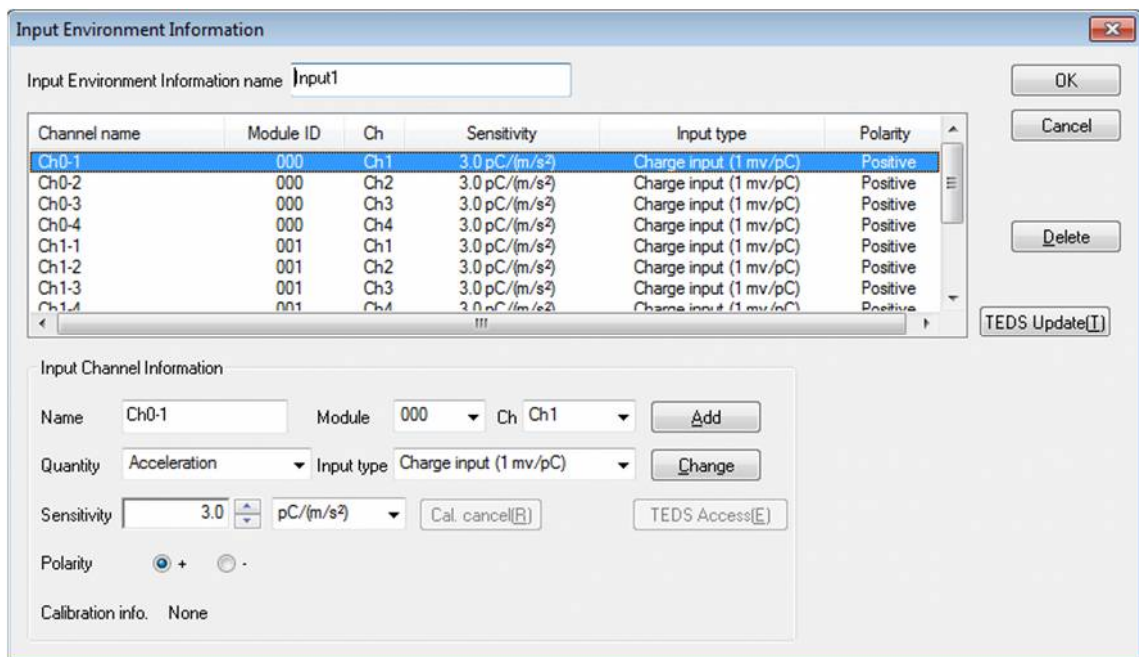

[Add]                    A new input channel is added.

[Change]                Defined content of a selected input channel is changed.

[Delete]                A selected input channel is deleted from the registration list.

The registered order just has the meaning of the order of a graph to be displayed.

[TEDS Update]        This button captures and automatically sets the input sensitivity of the IEPE input channel information registered in the input environment information from the connected IEPE sensor corresponding TEDS.

#### 3.4.1 Input Environment Information Name

(1) Meaning

This item is for inputting the registration name of Input Environment Information to be used.

#### 3.4.2 Name (Channel Name)

(1) Meaning

This item is for inputting the registration name of input channel.

### 3.4.3 Module / Ch.

(1) Meaning

This item is for setting of Module ID and number of Input Channel for I/O module or Input module to be used.

### 3.4.4 Quantities

(1) Meaning

This item is for setting of the physical quantity as the measurement objective of the sensor to be used.

### 3.4.5 Input Type

(1) Meaning

This item is for setting of the type of a sensor signal to be used as an electric signal when it is inputted to K2 system.

Three types of input format as below are supported for I/O Board or Input Board ;

1. AC Voltage Input :  $\pm 10$  V FS
2. DC Voltage Input :  $\pm 10$  V FS
3. Charge Input :  $\pm 10000$  pC FS (charge amplifier gain 1mV/pC)
4. Charge Input :  $\pm 1000$  pC FS (charge amplifier gain 10mV/pC)
5. IEPE Input :  $\pm 10$  V FS

'Charge Input' is selected when the acceleration pickup output of charge output type is directly connected to the I/O Module or Input Module.

I/O Module and Input Module are available to select both of gains because these modules have a charge amplifier for converting Charge/Voltage internally.

Please select a suitable gain according to the maximum acceleration level generated in the test to be operated.

To connect the IEPE output type acceleration pickup output directly to the I/O module or input module, select 'IEPE input'.

A CCLD amp (+ 24 VDC, 3.5 mA) is built in the I/O module or input module.

When other sensors are to be used, the voltage signal obtained by operating all the proper voltage conversion should be inputted. This item is to be set to 'Voltage Input'.

### 3.4.6 Sensitivity

(1) Meaning

This item is for setting of input sensitivity of the signal inputted to the input channel to be used.



### **3.4.7 Polarity**

(1) Meaning

This item is for specifying of polarity of input channel to be used.

When this item is set to 'Negative', the input signal of input channel is treated as a signal having the negative polarity. (That is, the data obtained after A/D converting multiplied  $-1$ .)

The default value of this item is set to 'Positive'.

### **3.4.8 TEDS Access**

(1) Meaning

Input sensitivity is captured and automatically set from the connected sensor corresponding TEDS.

This function is enabled when the input type is IEPE.

# Chapter 4 Fundamental Operation Method

## 4.1 Outline

In K2 application, operation after booting up is executed by using the keyboard and the mouse. The window displayed as below appears when this application is started.

The names of all menus available in this application are displayed at the menu bar. A list of available commands appears by clicking each name of menus.

Each tool bar displays the commands that are frequently used in the menu as icons.

When an icon is clicked, the command corresponding with this icon is operated or the dialog box corresponding with this command is opened.

Operation condition of K2 Controller is displayed in the status bar.

Condition during Excitation Operation is displayed in Operation Status Panel.

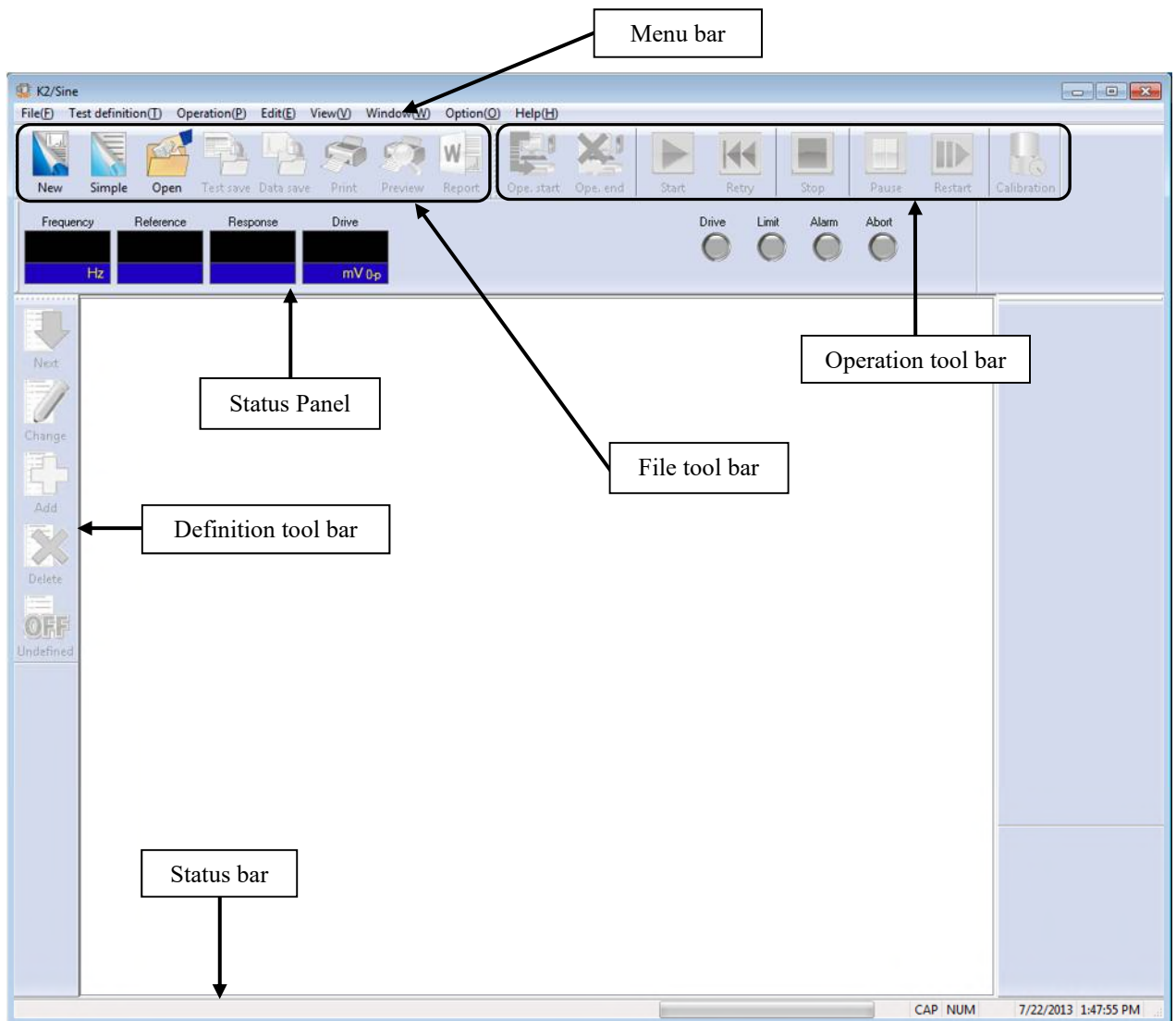

## 4.2 Fundamental Operation

### 4.2.1 Application Start Up

<Procedures>

<Step 1>

Double-click the “K2Launcher” on the desk top screen.

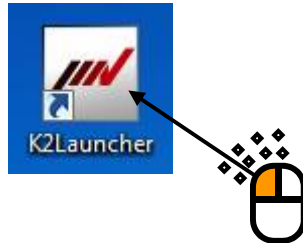

<Step 2>

The K2/Launcher is started.

Select the icon of the application to be started, and press the button of [Next].

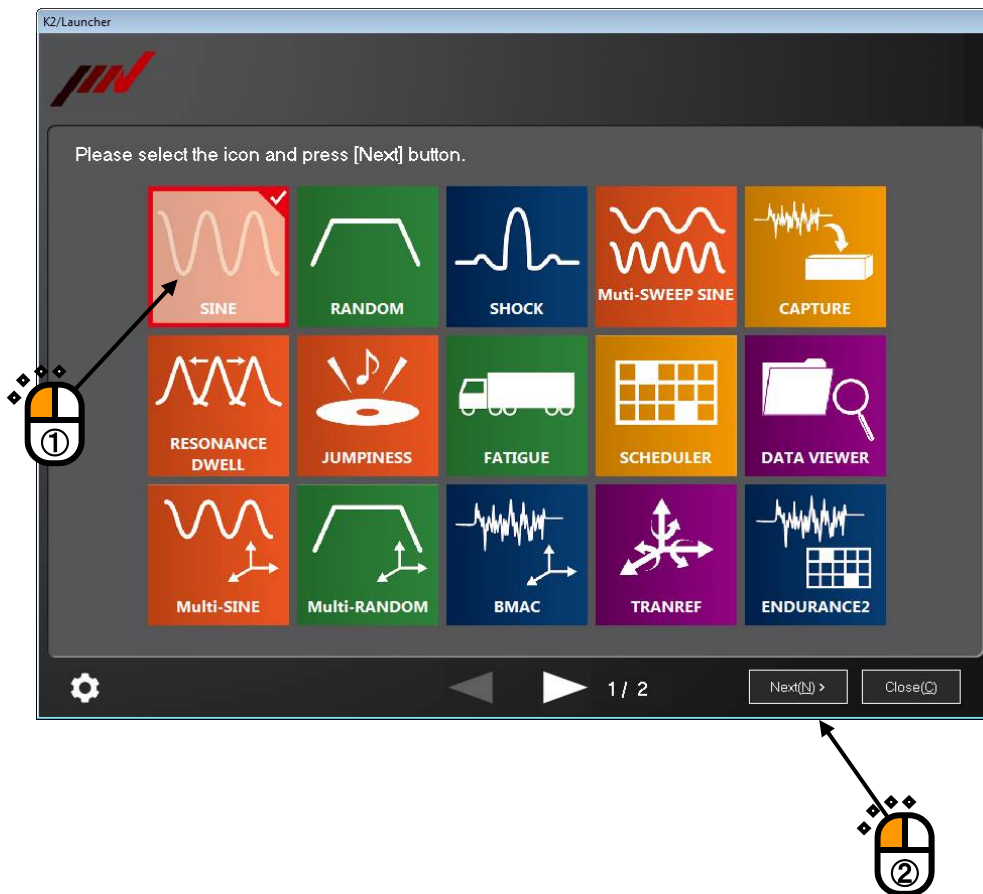

## 4.2.2 Exit from Application

### (1) K2/Launcher

Press the button [Close] on the screen.



## (2) Other applications

Following procedures are provided to exit from K2 application. In this clause, it describes the procedures to close the application by using the close button and using the command in the menu bar.

### ① Procedure of closing by Close Button

The application is ended by clicking the close button on the upper corner of the right in the window in Test Definition mode.

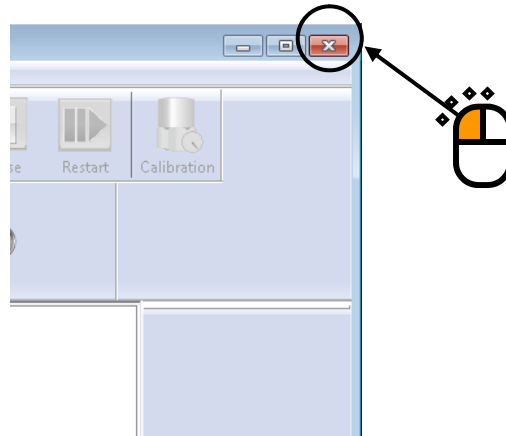

### ② Procedure of closing by the command in Menu Bar

Select [File] in the menu bar in Test Definition mode. The commands of [File] appear. The application is ended by selecting [Exit] among the commands.

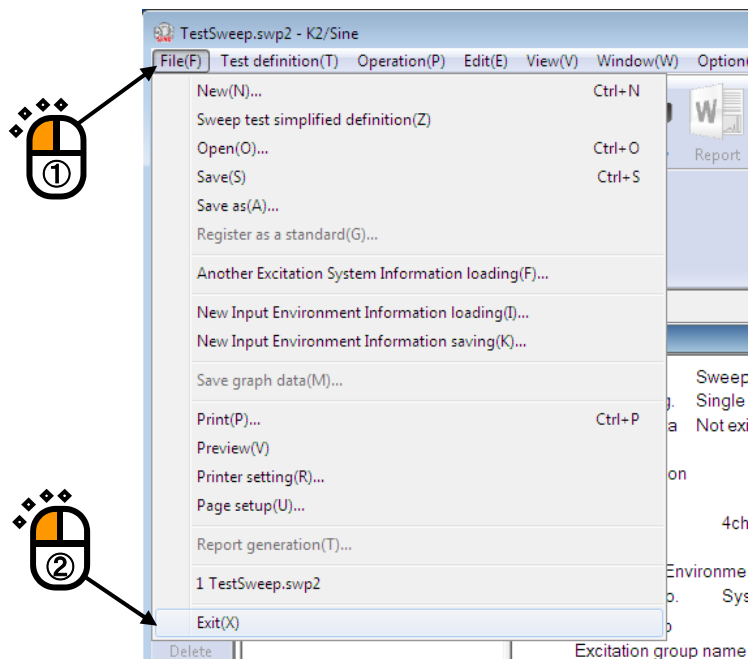

### 4.2.3 Description of Icons

The commands that frequently used in the menu bar are displayed as icons on the tool bar below the menu bar. When an icon is clicked, a command corresponding with the icon is executed immediately or a dialog box corresponding with this command is opened.

Actions of the system when each button of the tool bar is pressed are described as follows ;



This command is for creating a new test. Test Definition (Test Condition, Test Contents) is newly defined.



This command is for generating a new test in simplified definition mode. The contents of definition are limited but it is easy to be defined. (SINE, RANDOM, SHOCK)



This command is for opening the saved Test Definition file.



This command is for saving Test Definition of an operation objective in a file.



This command is for saving Data in a file.



Print



Print preview



Report generation on Microsoft Word



Quick report generation on web browser or Microsoft Word(Quick Report)



This command is for proceeding to Test Operation mode from Test Definition mode.

When Test Definition is not completed or inconsistencies are detected in Test Definition, the system cannot proceed to Test Operation mode.



This command is for proceeding to Test Definition mode from Test Operation mode.

In case of aborting the test, Operation Status, Continuous Excitation Data, Graph



This command is for starting the excitation or the acquisition operation.  
(SINE, RANDOM, CAPTURE)

In case of SHOCK, the action executed by this command is decided according to the status.

Waiting for the XFR Measurement start : XFR function is to be measured.

Drive Generation : Drive waveform data is generated from the reference data and Inverse XFR function.

Waiting for Excitation Start : Excitation operation is to be started.



When the test operation is stopped by the command of user or by detecting abnormal phenomenon, the button of [Retry] is set to valid.

This command is for proceeding to the waiting state for excitation /capture start by pressing this button after the test operation is stopped.



This command is for stopping of the test in operation.



This command is for pausing of the test in operation without the excitation.



This command is for canceling the paused state and continuing the excitation.



This Command is for operating Sensitivity Calibration of a pickup during the operation of a manual test. (Available only in SINE.)

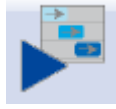

This command is for excitation start by level scheduling.  
(Available only in SHOCK)

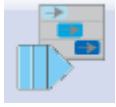

This command is for restart the excitation by level scheduling.  
(Available only in SHOCK)



Capturing is started by inputting Manual Trigger.  
(Available only in CAPTURE)



Undo the editing process operated to the data.  
(Available only in CAPTURE)



Calculation between numeral values is operated to the waveform data.  
(Available only in CAPTURE)



Edging process that makes the beginning and the ending point of waveform data smooth to zero is operated. (Available only in CAPTURE)



Data Length is converted by trimming the waveform data.  
(Available only in CAPTURE)



Filtering process is operated to the waveform data.  
(Available only in CAPTURE)



Frequency conversion of waveform data is operated.  
(Available only in CAPTURE)



## 4.2.4 File Operation

File management dialog in K2 application is described as below.

### 4.2.4.1 File Open

The dialog shown as below appears by the following procedures ;

- Select [File] in the menu bar and click [Open],
- or click the icon of [Open] in the tool bar.

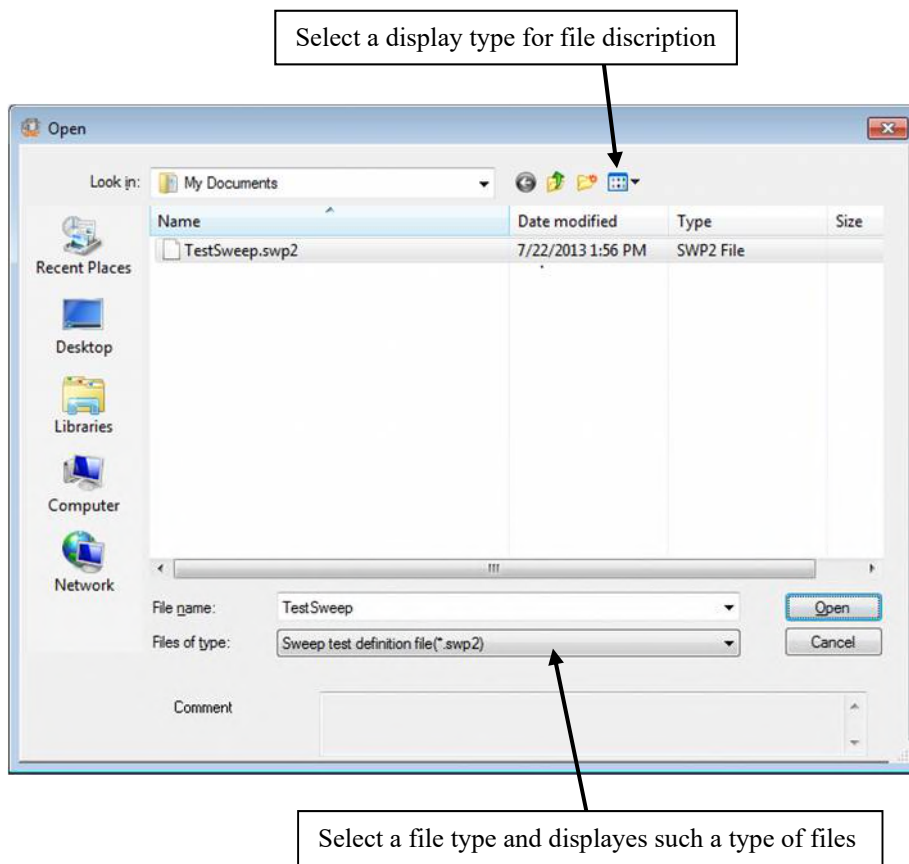

#### 4.2.4.2 Save As

The dialog shown as below appears by the following procedures ;

Select [File] in the menu bar and click [Save as],  
or operating the function of [Save] to save a new Test Definition File.

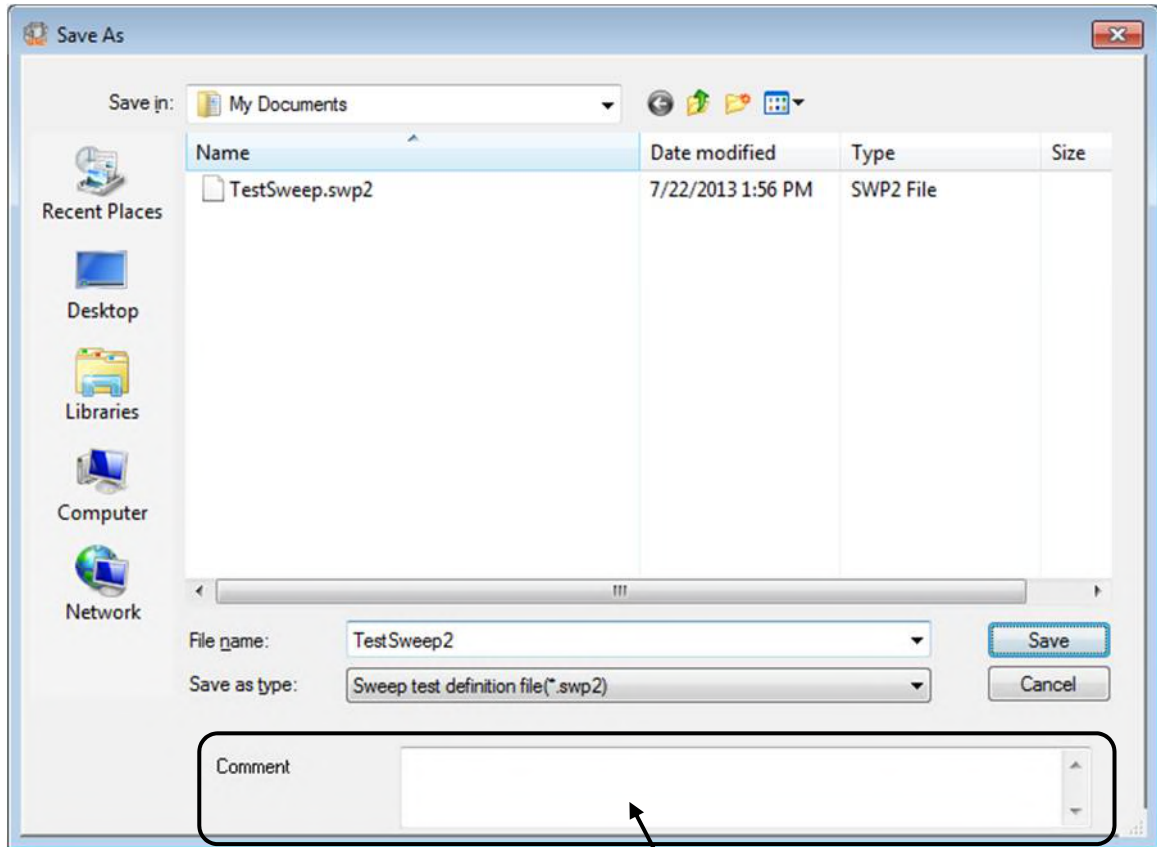

A comment can also be saved with a file name.

A comment can be inputted if it is necessary.

(In the dialog box for processing files dedicated to this system, 'Comment' to be inputted are used as comments of a file literally.)

## 4.2.5 Add a Page

This function is for adding of the pages for displaying graphs and logs in a manner which is frequently used in scratchpad software like EXCEL.

< Procedures >

< Step 1 >

Select [Window] in the menu bar and click [Add a Page].

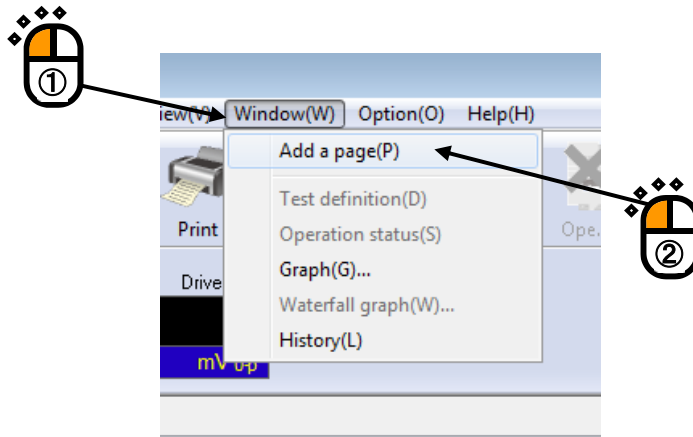

< Step 2 >

The picture as follows shows the display after executing the function of 'Add a Page'.

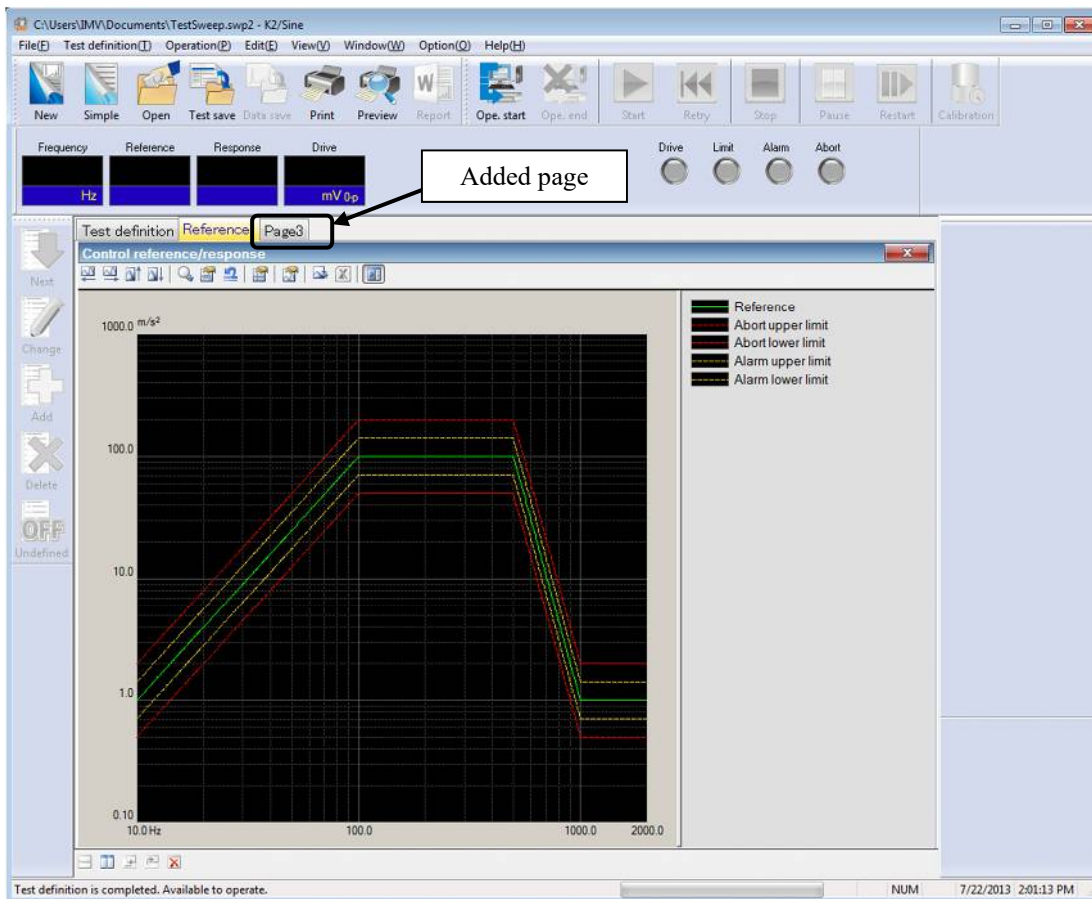

< Others > Rename the page

A name of the additional page can be changed by double clicking on the tab of the page in the display when it is necessary.

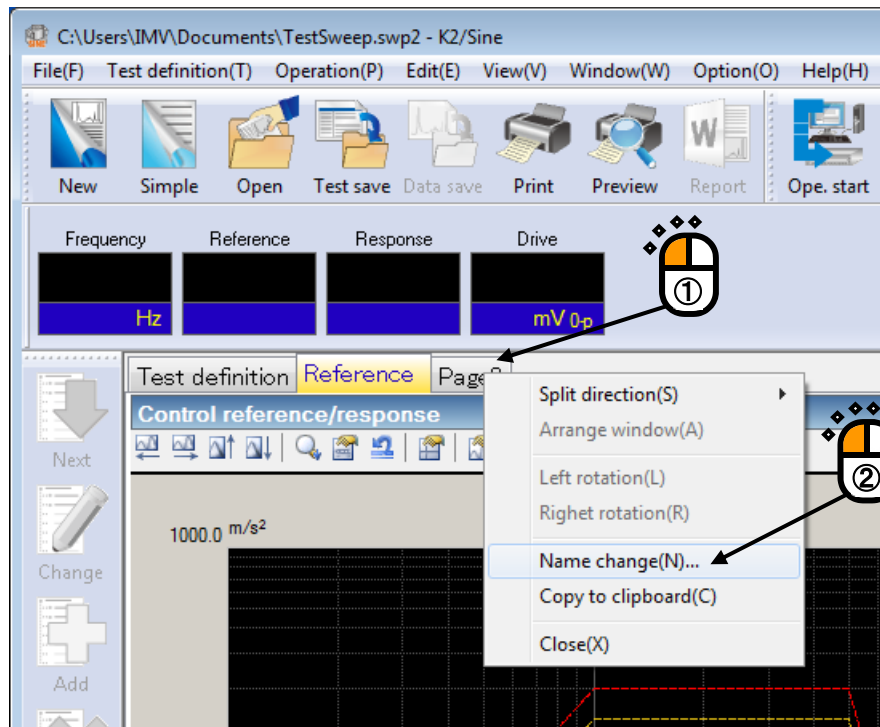

“Name change” window is displayed below;

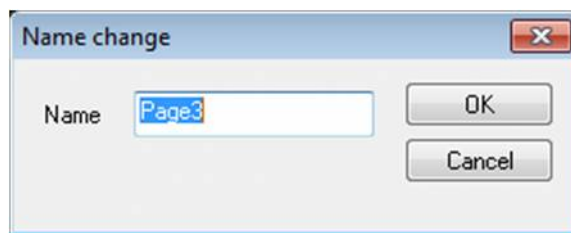

## 4.2.6 Palette Operation

K2 application provides the function that the display space (a palette) of graphs and logs can easily be moved or copied.

### 4.2.6.1 Palette Tool Icons

Commands used for handling pallets are indicated by icons on the lower part of graph display area. When any icon is clicked, corresponding command is executed immediately.



Pallets are indicated split horizontally. (Refer to “4.2.6.2 Moving the Palette”)



Pallets are indicated split vertically. (Refer to “4.2.6.2 Moving the Palette”)



Pallets are indicated split in a grid pattern. (Refer to “4.2.6.2 Moving the Palette”)



Positions of displayed some pallets are changed by turning them counterclockwise. (Refer to “4.2.6.2 Moving the Palette”)



Positions of displayed some pallets are changed by turning them clockwise. (Refer to “4.2.6.2 Moving the Palette”)



Deletes pallets.

#### 4.2.6.2 Moving the Palette

Palette can be moved by operating the palette operation button provided at the bottom of the displayed page.

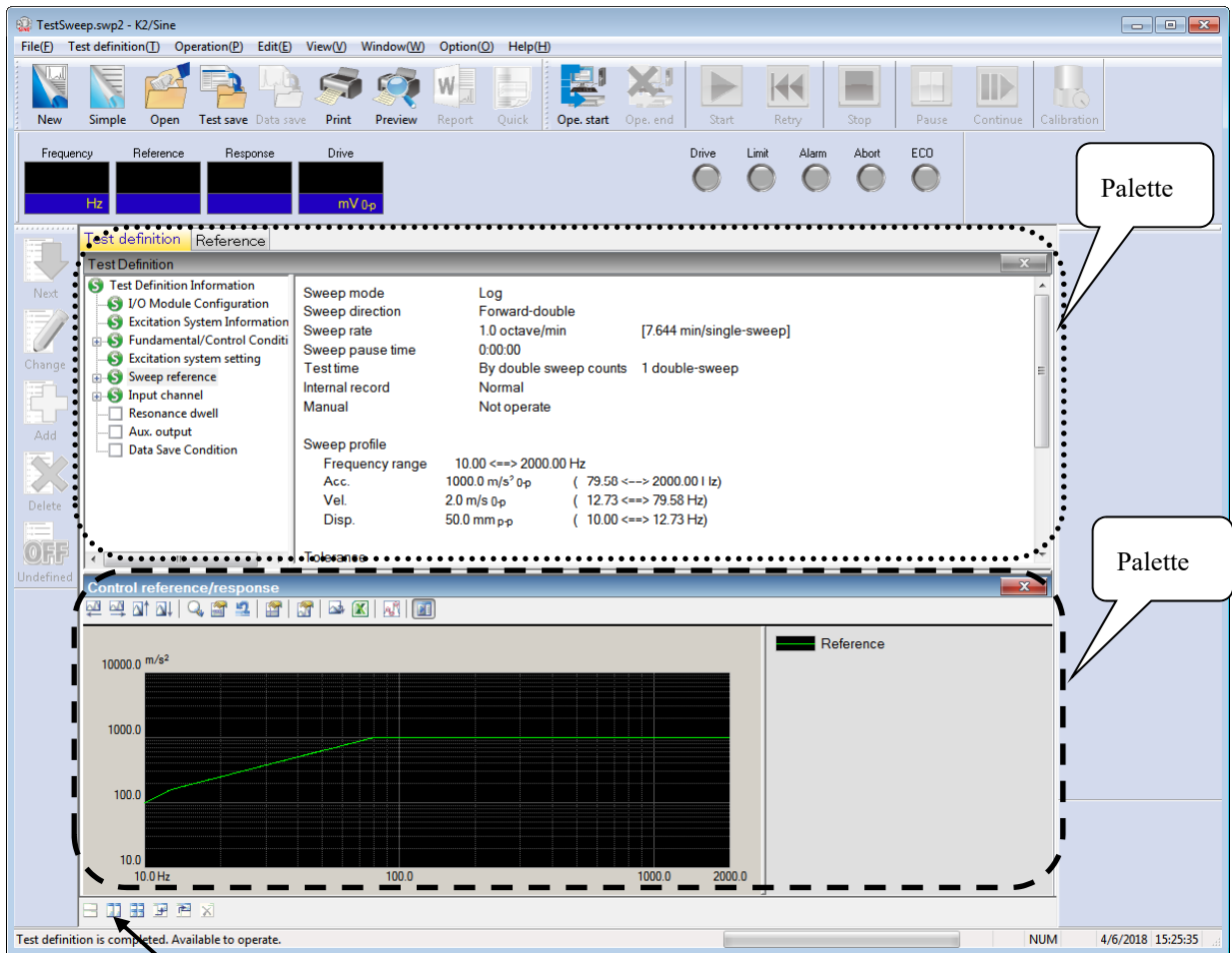

## **4.2.7 Other Operations**

### **4.2.7.1 Set Up**

In this clause, set up method of both Test Definition mode and Test Operation mode is described.

The set up methods vary depending on each application. Refer to the instruction manual of each application about the details.

### 4.2.7.2 Operation Status

The status of control in operation is displayed.

Frequency	Reference	Response	Drive	Elapsed time	Vibration Cycle
13.02	1.6941	1.6602	5.4	0:00:05	21
Hz	m/s <sup>2</sup> 0-p	m/s <sup>2</sup> 0-p	mV 0-p		cycle

Reference/Response		Operation status	
<b>Operation status</b>			
In excitation			
Frequency	13.02 Hz	2013/07/22 2:03:36 PM	
Ref.(m/s <sup>2</sup> 0-p)	1.6941	Resp.(m/s <sup>2</sup> 0-p)	1.6602
		Drive(mV)	5.4
Elapsed time	0:00:05	21 cycle	
Sweep	Forward(F)	1 / 1 double-sweep	
Manual	0.00 dB	Sweep rate magnification	1.0
Check result		Alarm	OK
		Abort	OK
Real-time processing CPU load factor		0.15 %	
<b>Reference/Response data</b>			
	Acceleration	Velocity	Displacement
	(m/s <sup>2</sup> )	(m/s)	(mm)
Ref.	1.6941	2.072e-2	0.5066
Resp.	1.6602	2.030e-2	0.4965
<b>Input channel data</b>			
Peak estimation	Acceleration	Velocity	Displacement

### 4.2.7.3 Manual Operation

The control reference can be changed during the excitation by using manual operation box.

The set up methods vary depending on each application. Refer to the instruction manual of each application about the details.



## 4.3 Graph Operation

It describes about items that are used for graph operations such as selecting of graph display and changing of scale as below.

### 4.3.1 Graph Tool Icons

Commands used for handling graphs are indicated by icons on the upper part of graph display area. When any icon is clicked, command corresponding to the icon will be executed immediately, or a dialogue box corresponding to the command appears.



Moves in graph display area leftward.



Moves in graph display area rightward.



Moves in graph display area upward.



Moves in graph display area downward.



Changes graph zooming by dragging.  
(Zooming horizontally only, vertically only, and in both directions are allowed)



Changes graph scale. (Refer to “4.3.3 Scale”)



Returns scale to the initial status.



Displays a cursor. (Refer to “4.3.4 Cursor Display”)



Changes the currently displayed graph. (Refer to “4.3.5 Graph Change”)



Converts a graph into CSV data. (Refer to “4.5.1 File conversion to CSV”)



Outputs a graph on Excel. (Refer to “4.5.2 Graph display on Excel”)



Displays peak marks. (Refer to “4.3.6 Peak Mark”)



Displays legends.

### 4.3.2 Selecting of Graph Display

A graph is displayed by selecting the data from the data of Test Definition and Test Operation.

< Procedures >

< Step 1 >

Select “Window” in the menu bar and click “Graph” among the items.

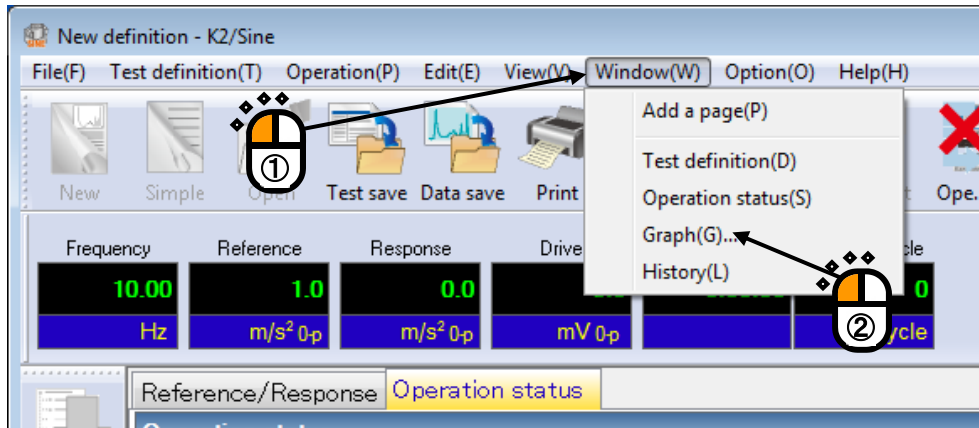

< Step 2 >

Select one item each in the list of Graph type and another descriptions and press the [OK] button.

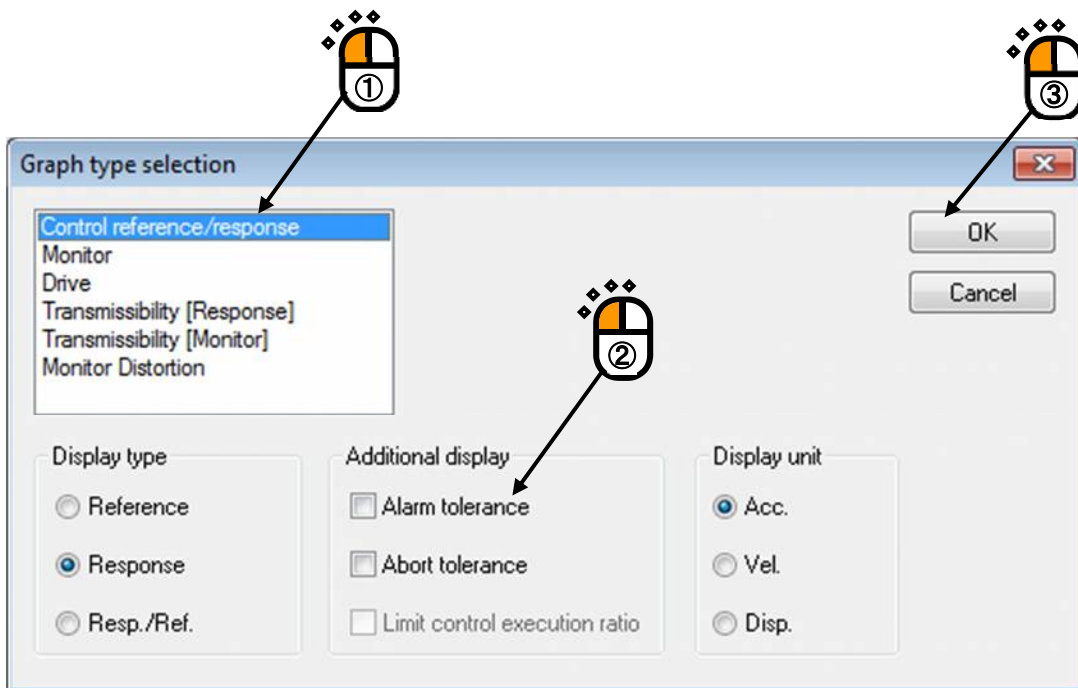

< Step 3 >

A graph of the page displayed currently appears in the display.

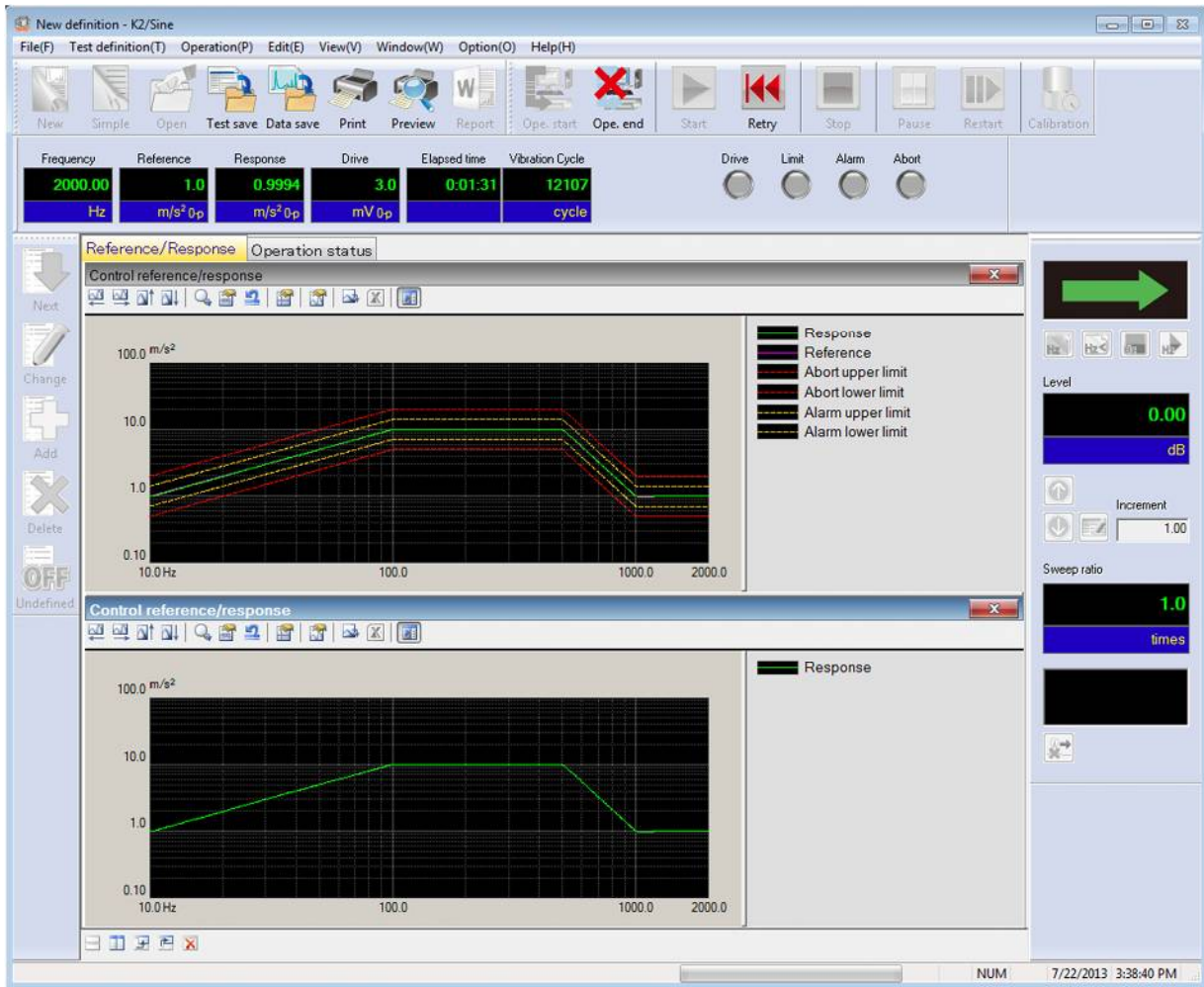

#### 4.3.2.1 Selecting of 3D graph

Three types of 3D graphs are available. Applications applicable to the 3D graphs are shown below.

- [1] Waterfall graph (depth fixing)  
SINE (SPOT test is unavailable), RANDOM, SHOCK, CAPTURE, DATA VIEWER
- [2] Waterfall graph (Scroll display)  
SINE (SPOT test is unavailable), RANDOM, SHOCK
- [3] Color map  
DATA VIEWER

This section explains how to display waterfall graphs.

(For details of [3] Color map, refer to “Chapter 6 DATA VIEWER”.)

- [1] Waterfall graph (depth fixing)

Types of graphs applicable to this graph are as shown below.

- SINE: Monitor, Transmissibility[Monitor], Monitor Distortion
- RANDOM: PSD[Monitor], Transmissibility[Monitor], Sine Data[Monitor]
- SHOCK: Monitor, Transmissibility[Monitor]
- CAPTURE: Waveform, PSD, Transmissibility[Monitor]
- DATA VIEWER: Graph types of the above applications

The following is the explanation of display procedures taking SINE monitor graph as an example.

< Procedure >

< Step 1 >

Proceed to < Step 2 > of the selection of graph to be displayed in the former “section 4.3.2”.

< Step 2 >

Select “Waterfall graph” from Graph type, and press [OK] button.

(For DATA VIEWER only, “Color map” can be selected here.)

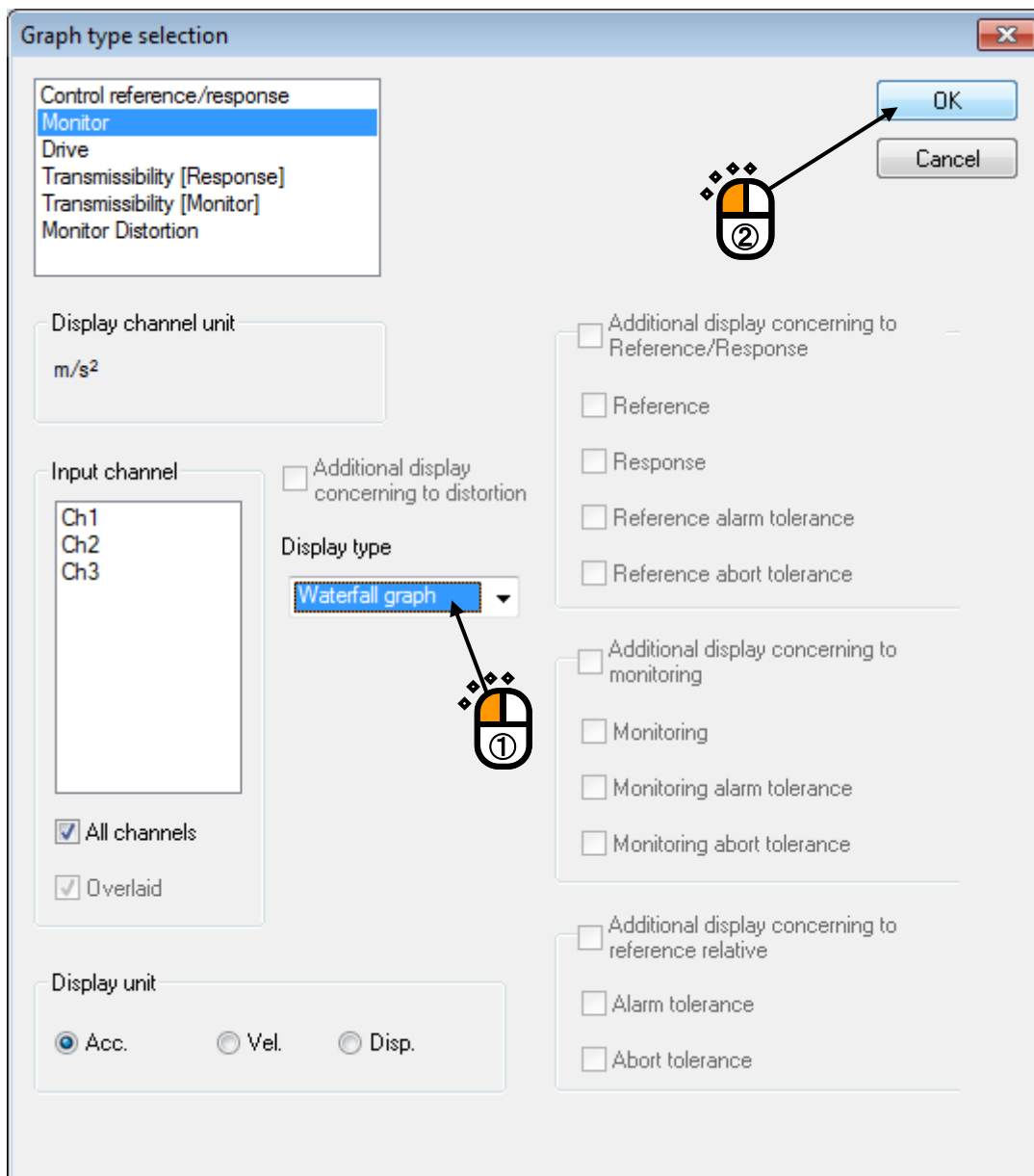

< Step 3 >

Additional graph appears on the currently displayed page.

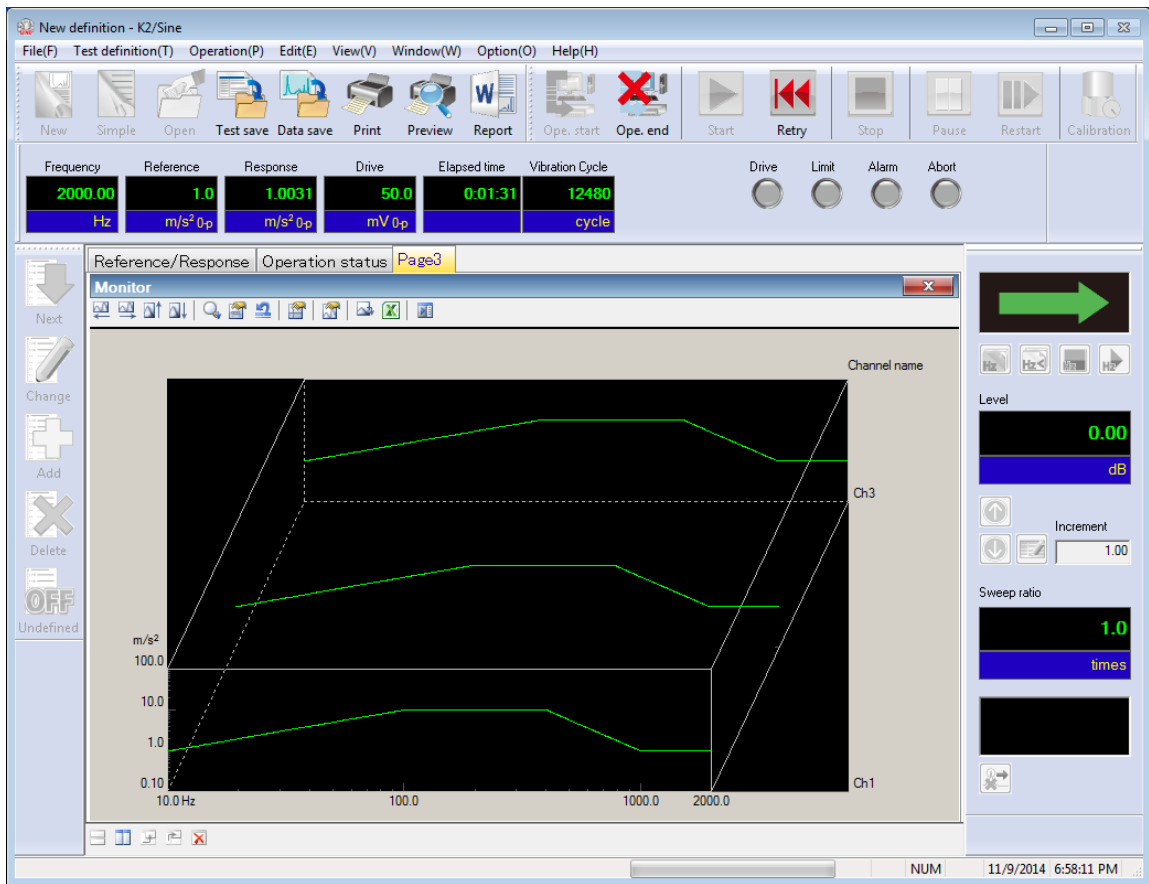

[2] Waterfall graph (scroll display)

New data is added foremost, and the past data is withdrawn sequentially.

When the number of displayed data reaches the maximum number of depth data, the oldest data is deleted whenever new data is added.

The following is the conditions for data addition.

SINE, SOR: When single sweep is completed

RANDOM: At loop renewal

SHOCK: When excitation is finished

Notes)

Data before waterfall graph (scroll display) is displayed will not be drawn.

If the type or the maximum number of depth data is changed by “Graph Change” button, data will be initialized, and deleted completely.

< Procedure >

< Step 1 >

Select “Window” in the menu bar, and click “Waterfall graph”.

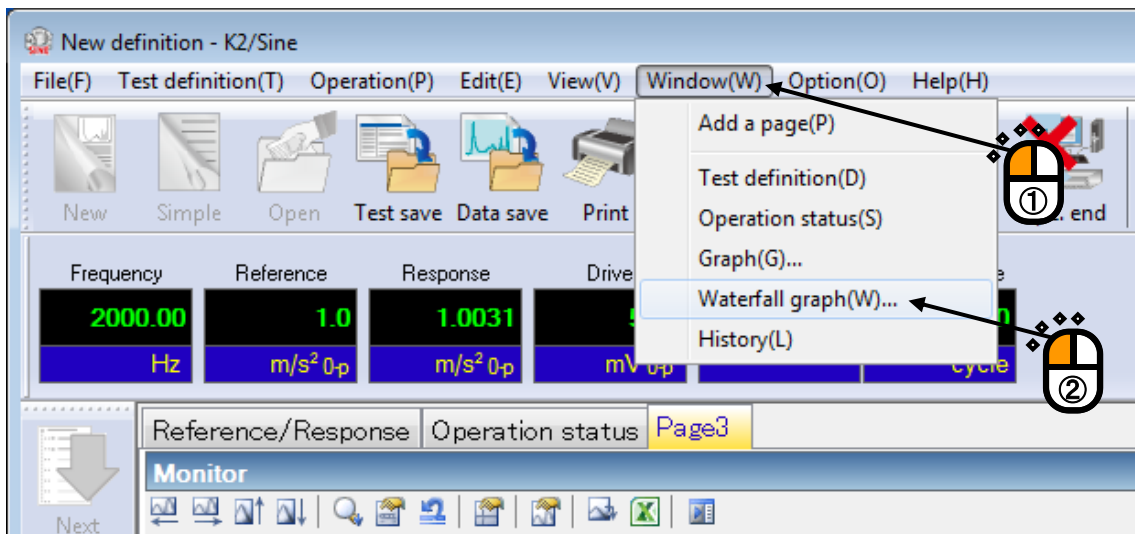

< Step 2 >

Select graph type and depth axis data, and set up the maximum number of depth data.

If “Monitor” is selected as displayed data, select your desired input channel.

After all the setup is complete, press [OK] button.

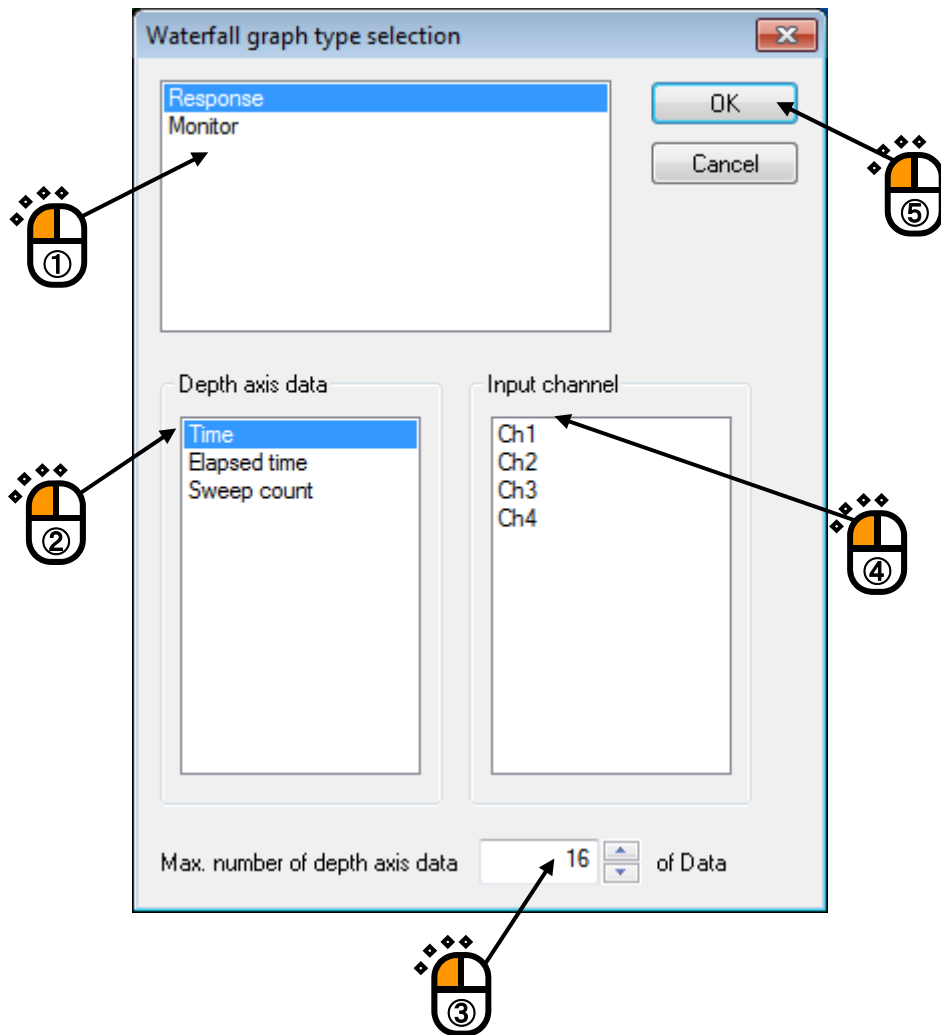



< Step 3 >

Additional graphs appear on the currently displayed page. (At this time, data line is not drawn.)

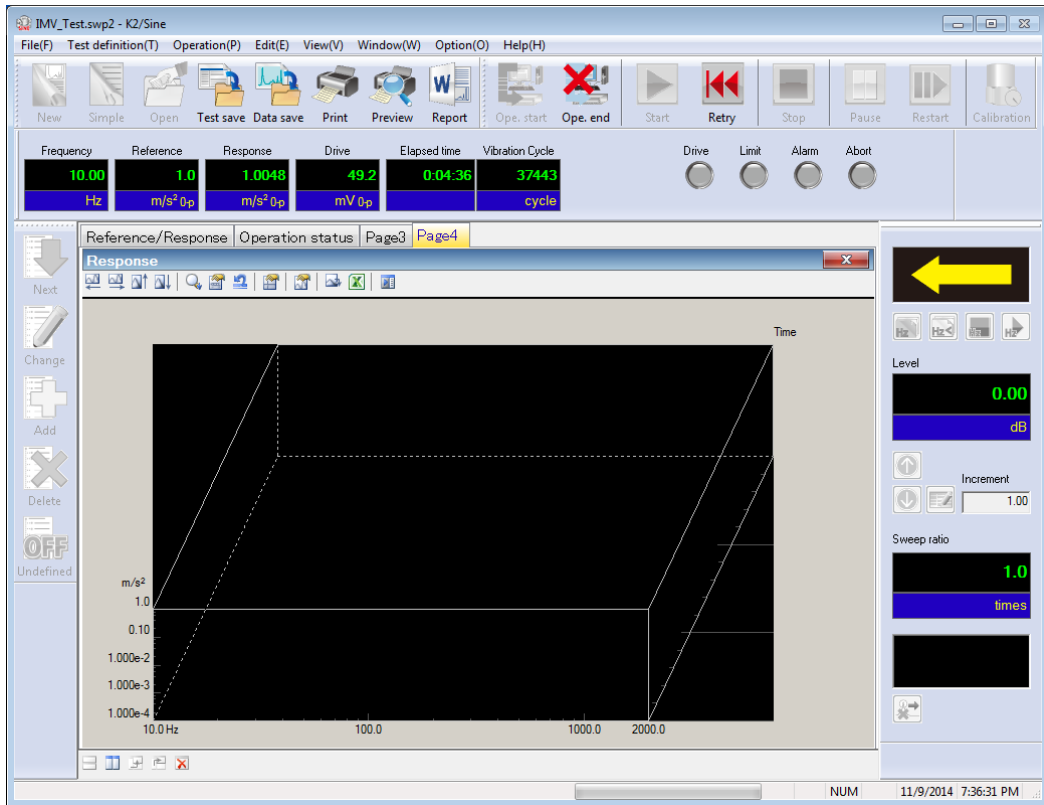

When the conditions for data addition described above are satisfied, data is added sequentially.

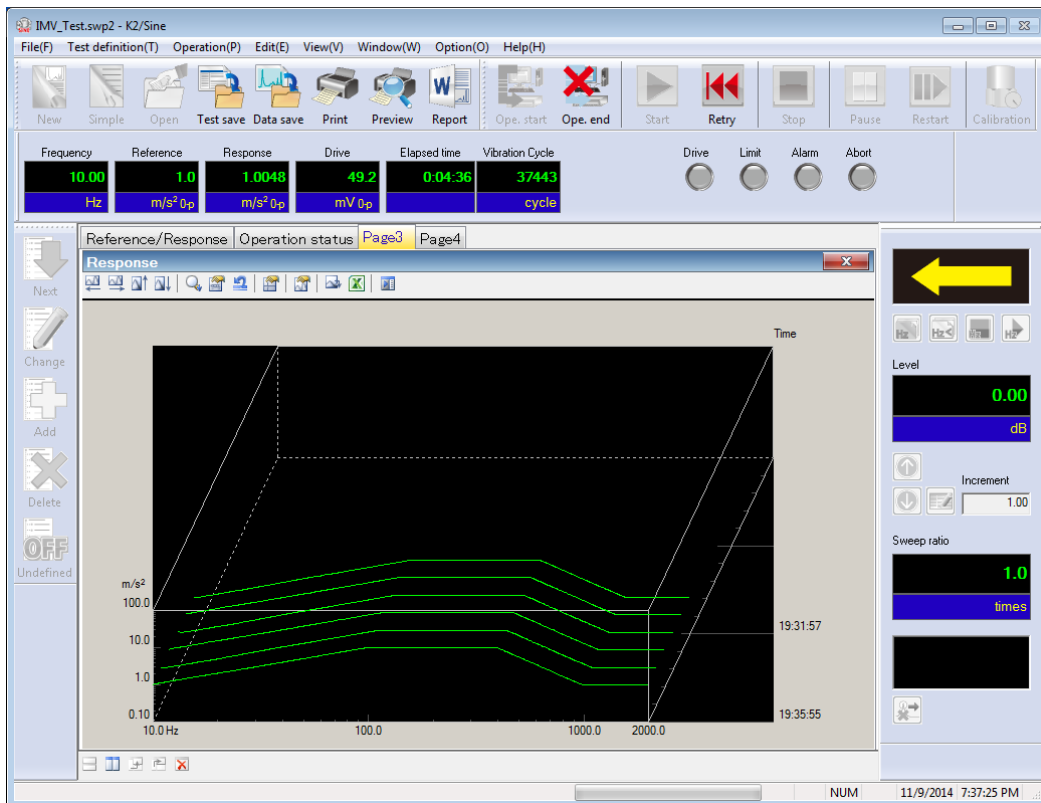

### 4.3.3 Scale

This function is for changing the scale of the graph displayed currently for its vertical and horizontal axes.

< Procedures >

< Step 1 >

Click a “Scale change button” on the graph display window.

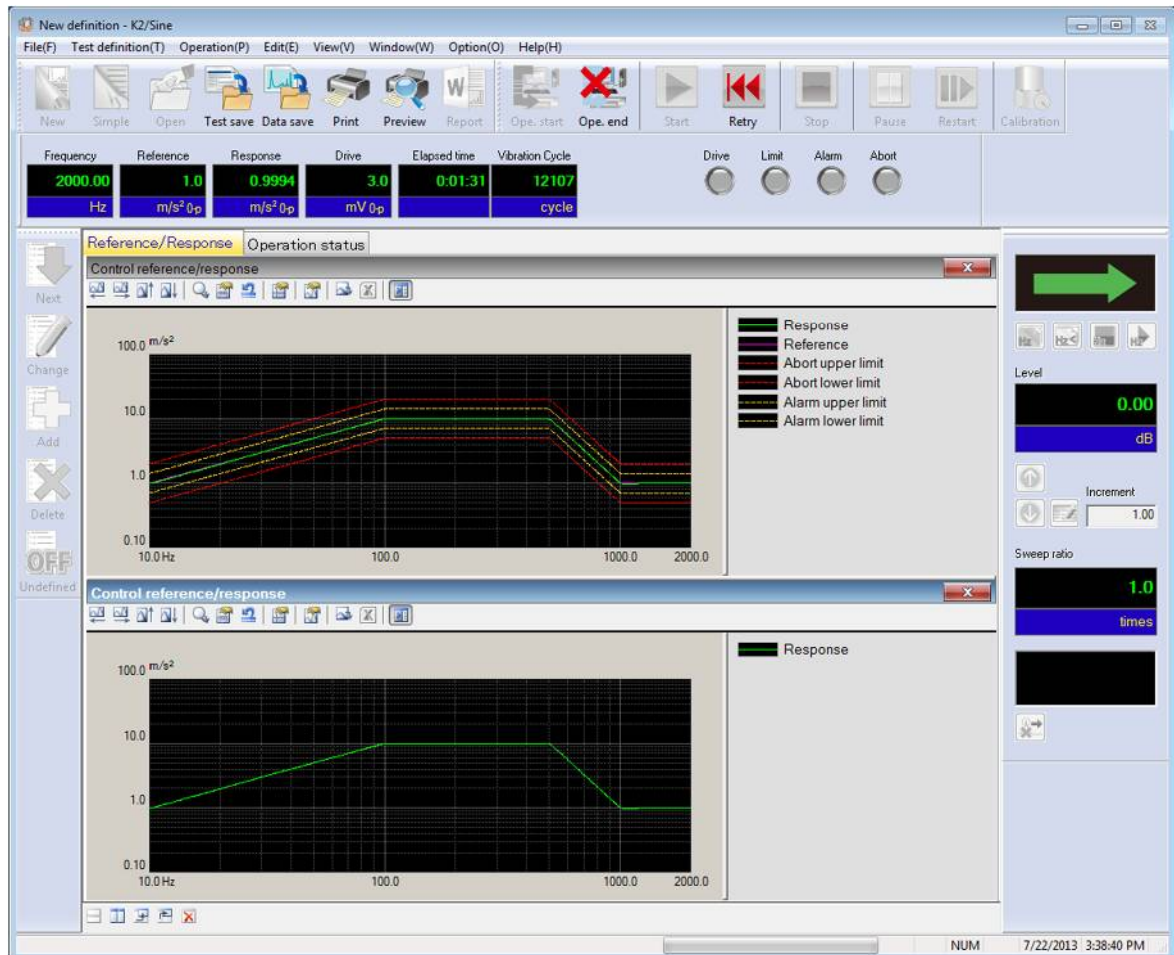

< Step 2 >

Change values of the graph range for horizontal axis displayed and press the [OK] button.

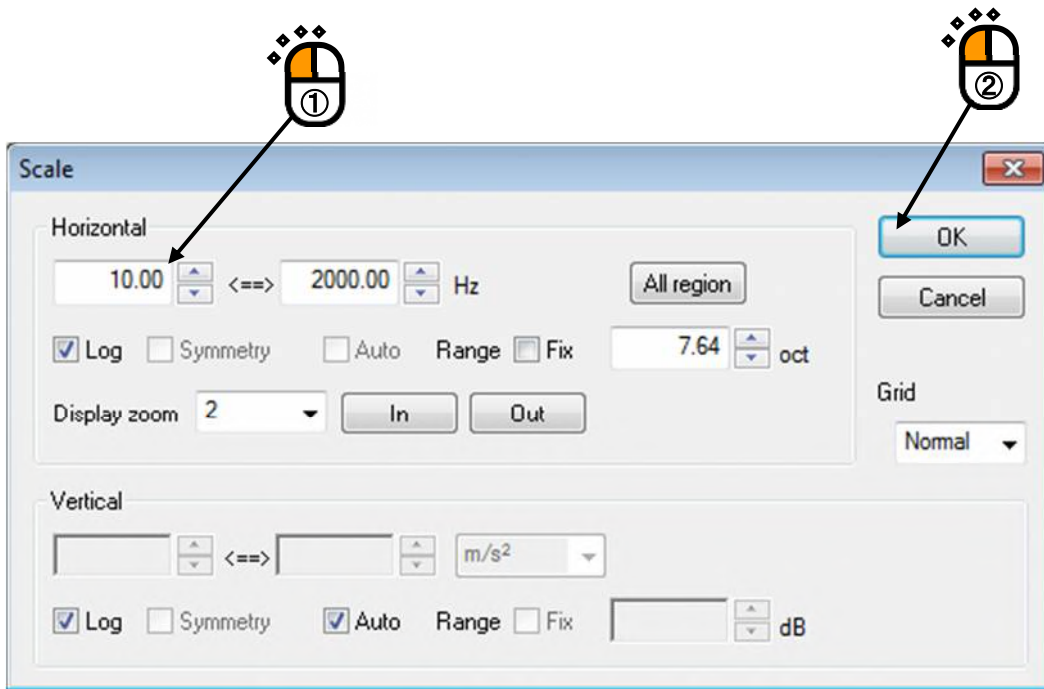

### 4.3.3.1 3D graph scale change

In 3D graphs, the scale of depth axis can be changed.

The setup items are as shown below.

- |                             |  |
|-----------------------------|--|
| Display first No.*:         | First No. of displayed data can be set up.                     |
| Display last No.*:          | Last No. of displayed data can be set up.                      |
| Hidden line display:        | Lines hidden backward (hidden lines) can be displayed.         |
| Reverse direction display*: | Data with large number can be placed foremost.                 |
| Ratio of horizontal axis:   | The horizontal axis ratio of graph display area can be set up. |
| Ratio of vertical axis:     | The vertical axis ratio of graph display area can be set up.   |

\* Setup is not allowed by “Waterfall graph (scroll display)”.

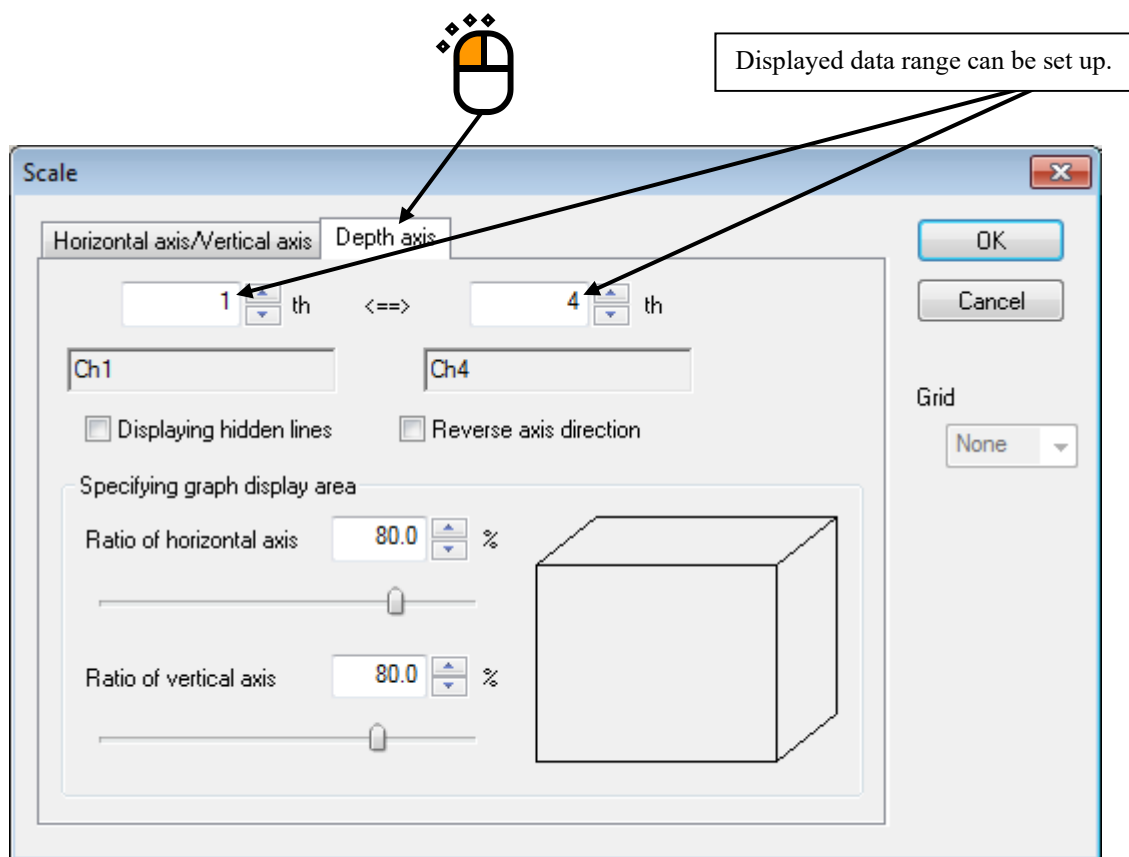

### 4.3.4 Cursor Display

This function is for displaying of hairline cursors in a specified graph currently displayed.

< Procedures >

< Step 1 >

Right-click the mouse button on the graph or click the “cursor button” to display the cursor in the graph.

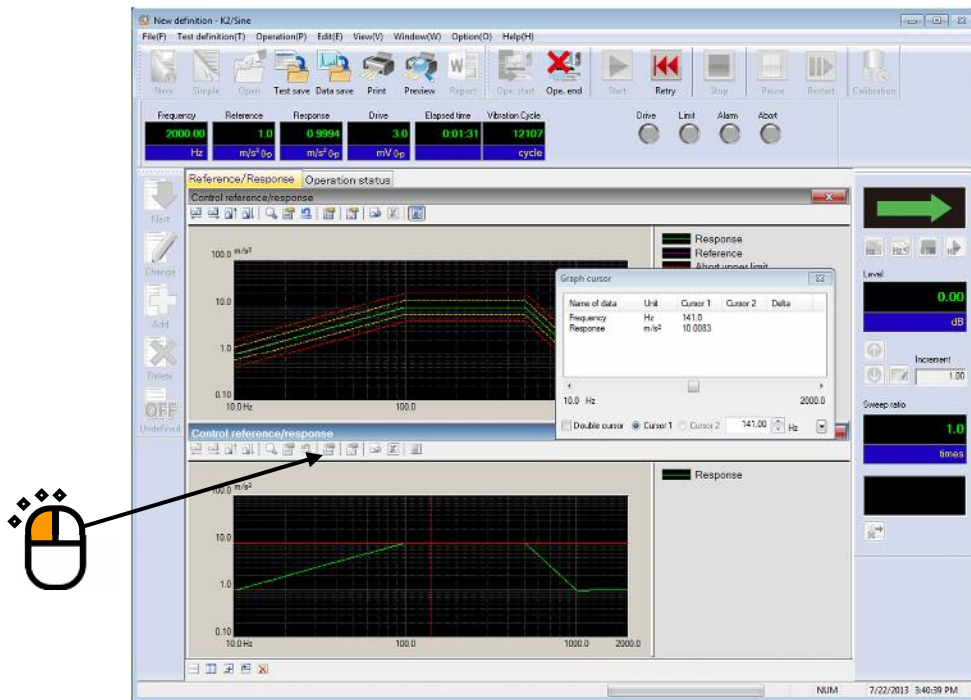

< Step 2 >

Use the dialog of ‘Graph cursor’. The cursor in the graph is shifted by the operation.

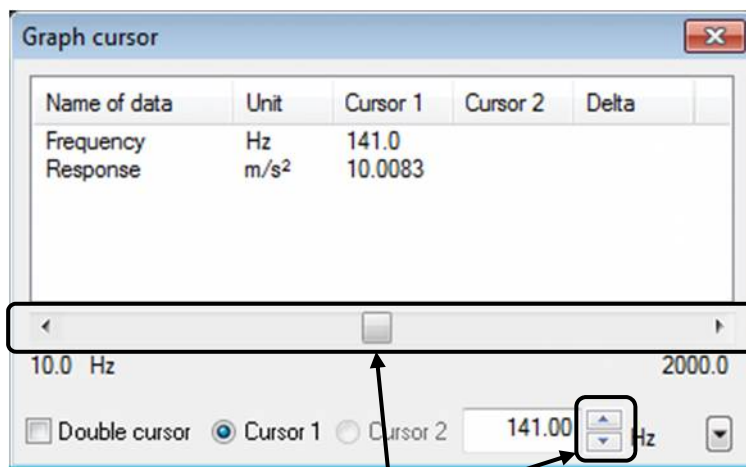

Use these buttons to shift the cursor by a mouse.

#### 4.3.4.1 Double cursor display

< Operating procedure >

< Step 1 >

Check double cursor in the graph cursor dialog box.

Cursor 2 is enabled.

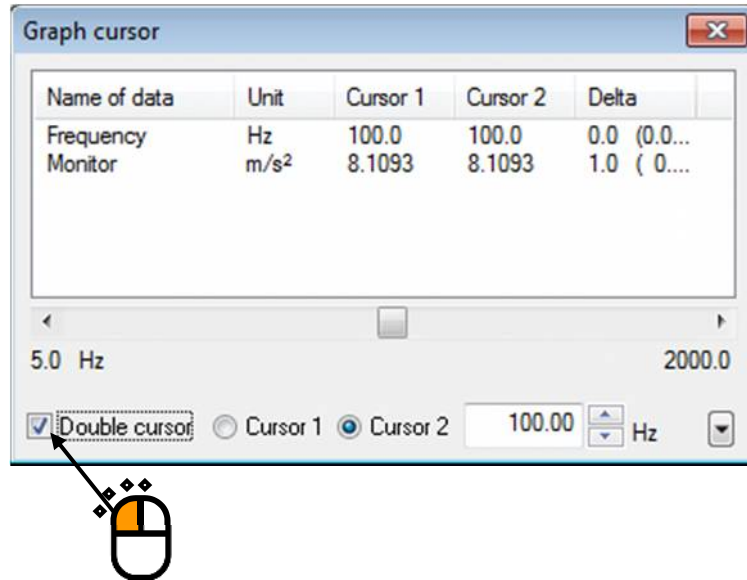

< Step 2 >

Select and operate cursor 2.

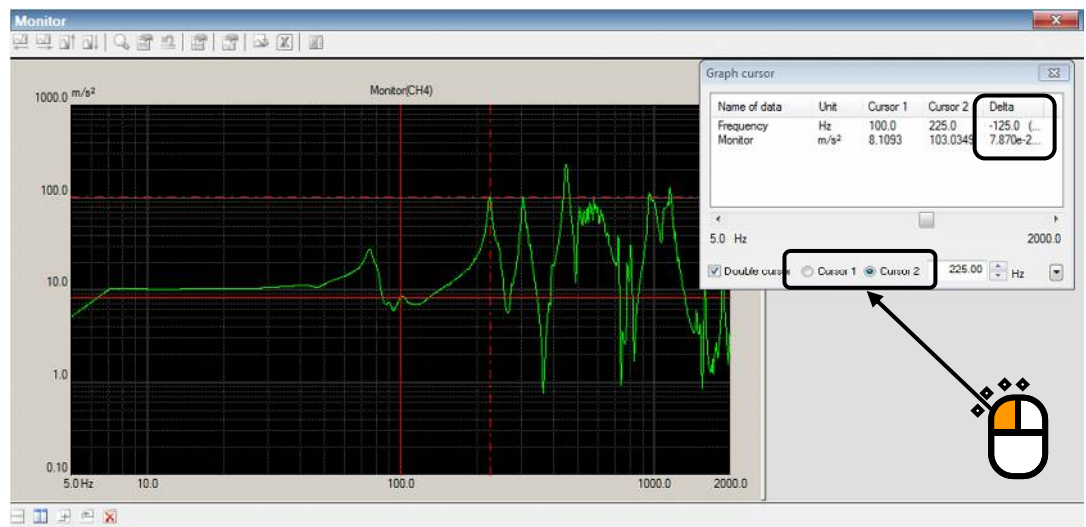

If cursor 1 is selected, you can operate cursor 1.

The graph cursor dialog box displays the difference between cursor 1 and cursor 2.

#### 4.3.4.2 Peak search

< Operating procedure >

< Step 1 >

Press the down arrow at the lower right corner of the graph cursor dialog box.

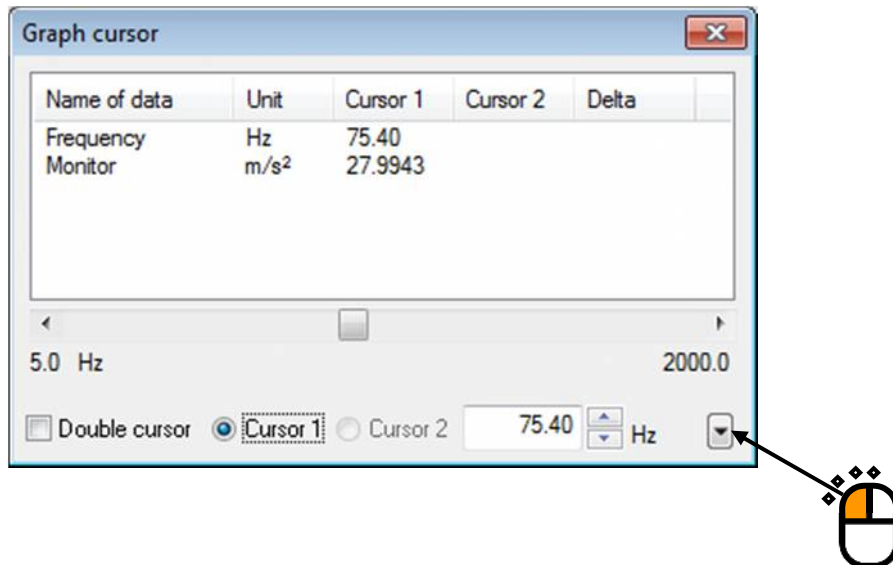

< Step 2 >

The peak search setting window opens.

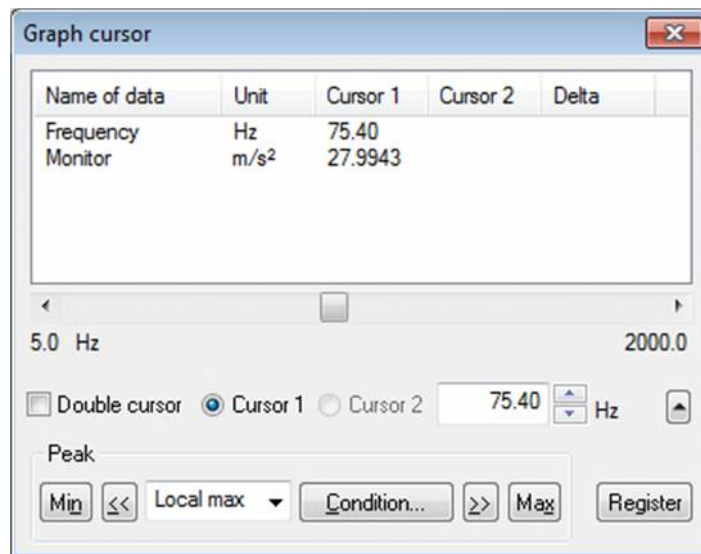

Press the following buttons to search the peak and move the cursor:

- [<<] : Searches the peak in the horizontal axis minus direction.
- [>>] : Searches the peak in the horizontal axis plus direction.
- [Min] : Searches the minimum value.
- [Max] : Searches the maximum value.
- [Condition] : Sets the conditions of peak determination.

- Peak is searched within the displayed graph scale range.
- The peak to search can be selected from 'Max./ Min./Both'.
- Click the data displayed in the list to select the data to search.

#### 4.3.4.3 Registration of cursor data

< Operating procedure >

< Step 1 >

Press the [Register] button in the peak search setting window.

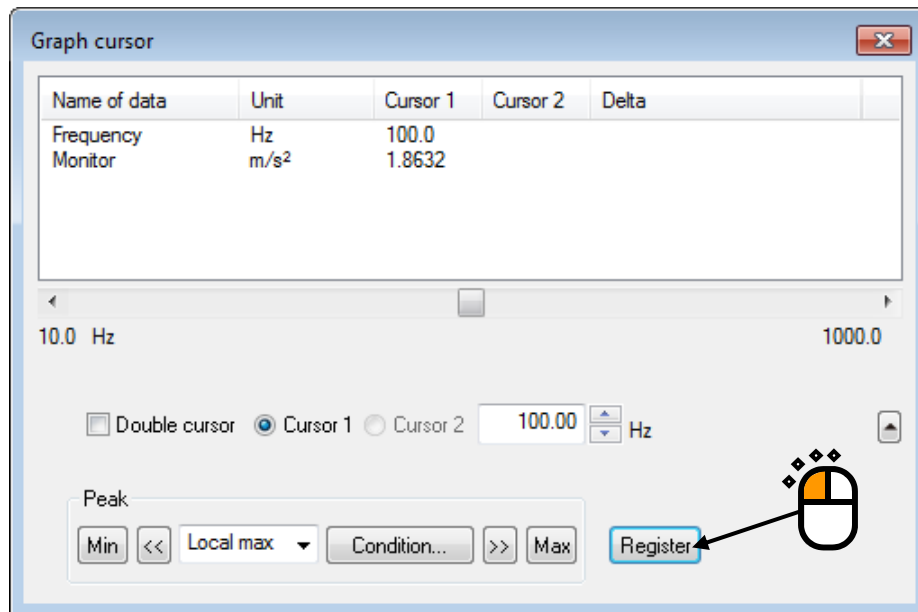

< Step 2 >

The cursor data selected when the [Register] button has been pressed will be saved in the list.

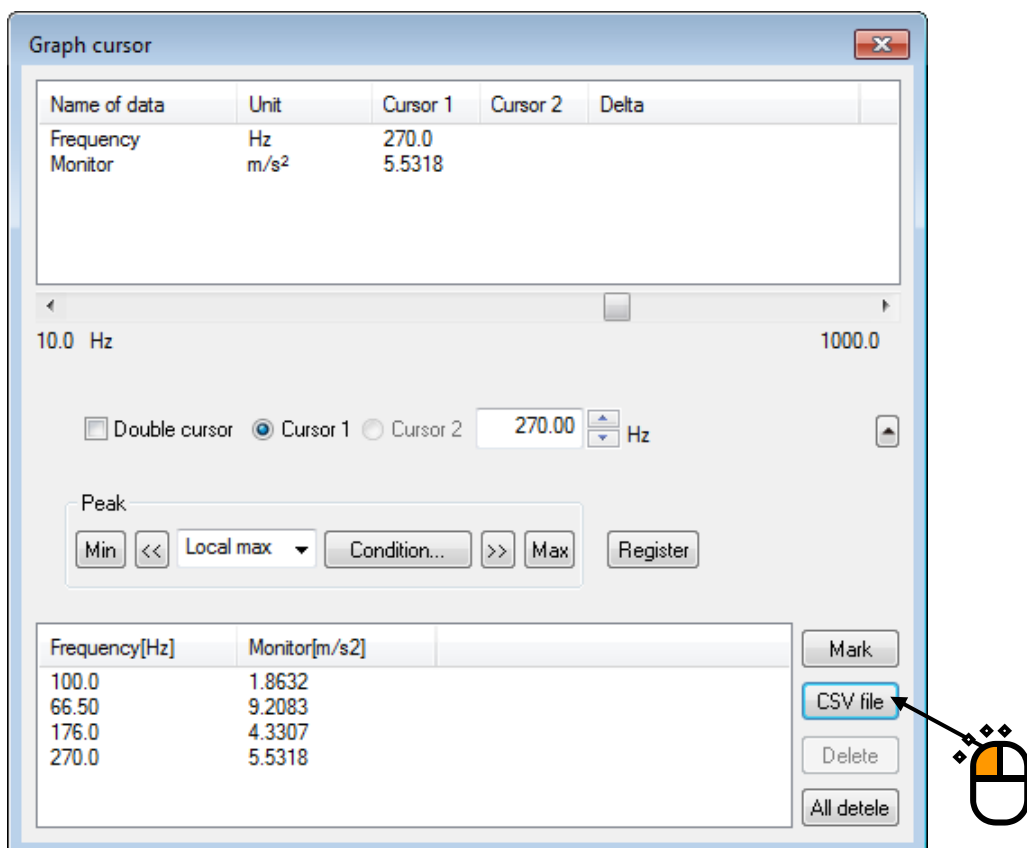

Press the [CSV File] button to save the cursor data displayed in the list in a CSV file.



< Step3 >

Press the [Mark] button to mark the cursor data displayed in the list.

Name of data	Unit	Cursor 1	Cursor 2	Delta
Frequency	Hz	270.0		
Monitor	m/s <sup>2</sup>	5.5318		

  

Frequency[Hz]	Monitor[m/s <sup>2</sup> ]
100.0	1.8632
66.50	9.2083
176.0	4.3307
270.0	5.5318

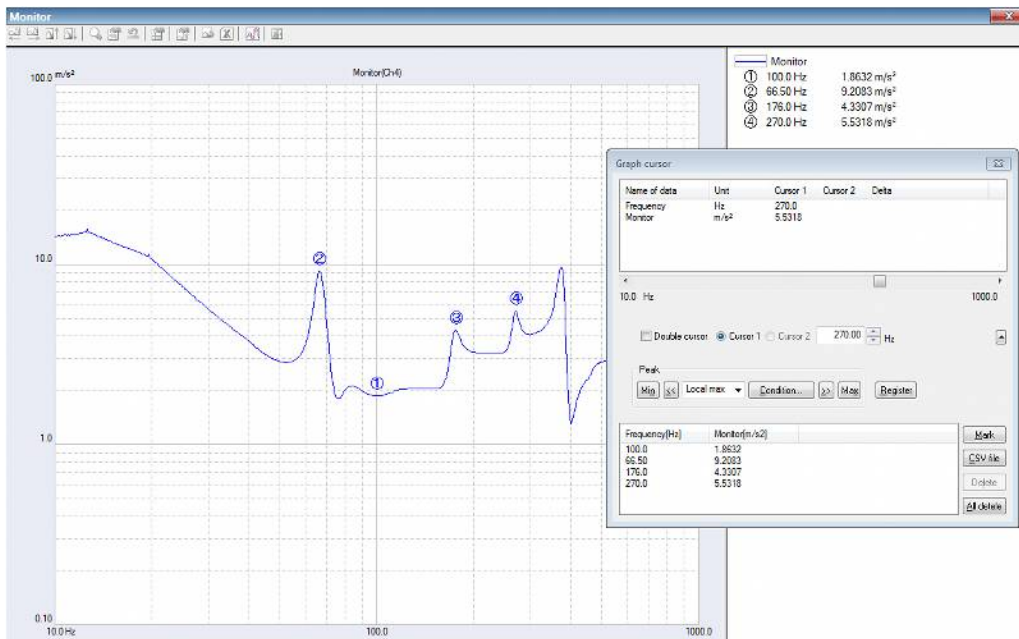

#### 4.3.4.4 Cursor display in 3D graph

Although the operation procedures are similar to those of normal graph, depth data needs to be selected.

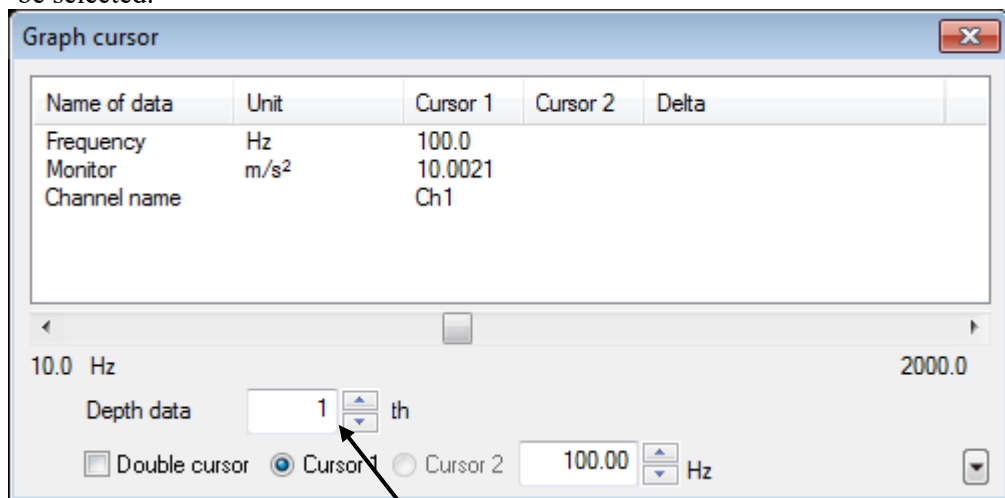

### 4.3.5 Graph Change

The graph displayed in the current display is changed.

< Procedures >

< Step 1 >

Click a “Graph change button” on the graph display window.

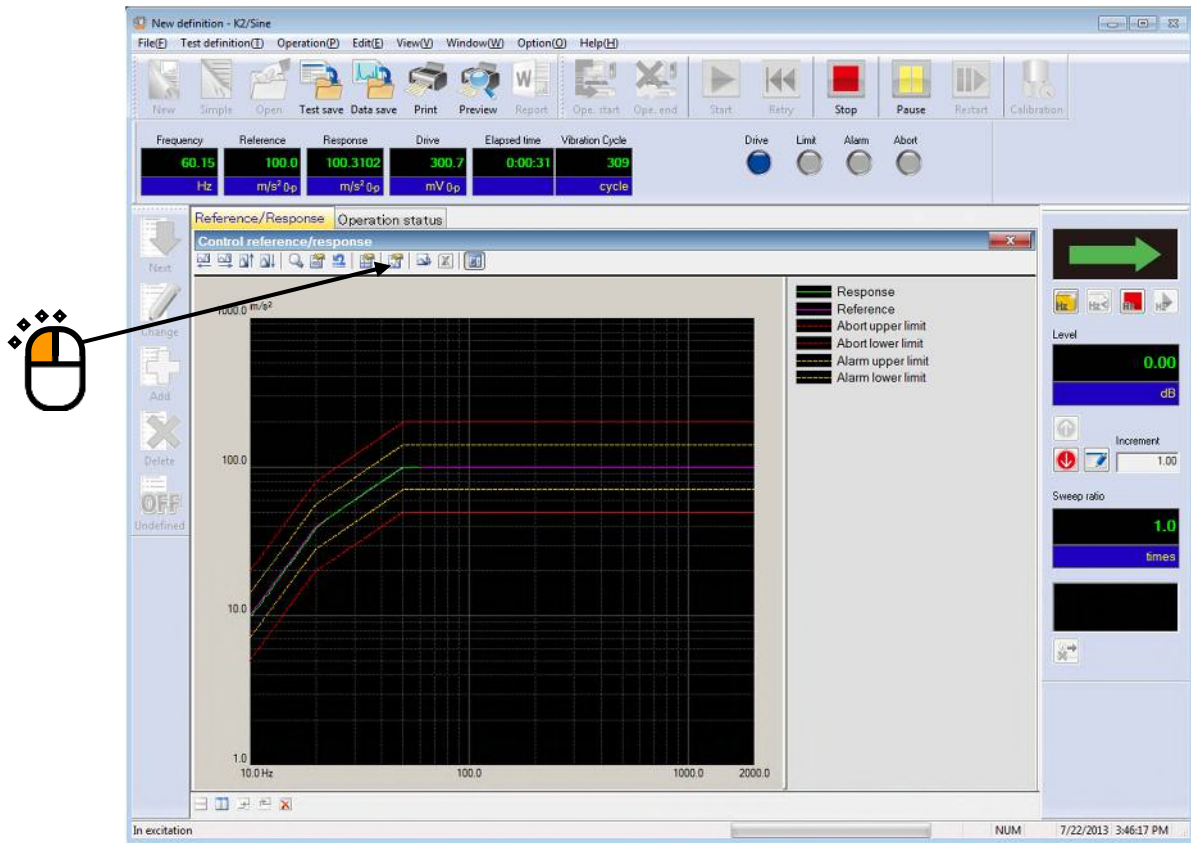

< Step 2 >

Select one item each in the list of Graph type and another descriptions and press the [OK] button.

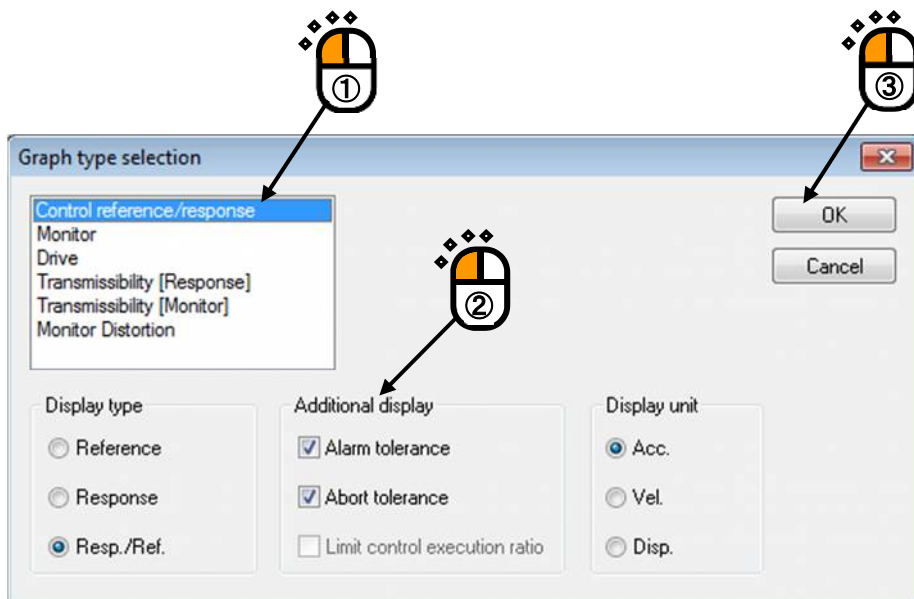

### 4.3.6 Peak Mark

Peaks and valleys in the graph data currently displayed can be marked.

< Procedures >

< Step 1 >

Click the icon of “Peak Mark”.

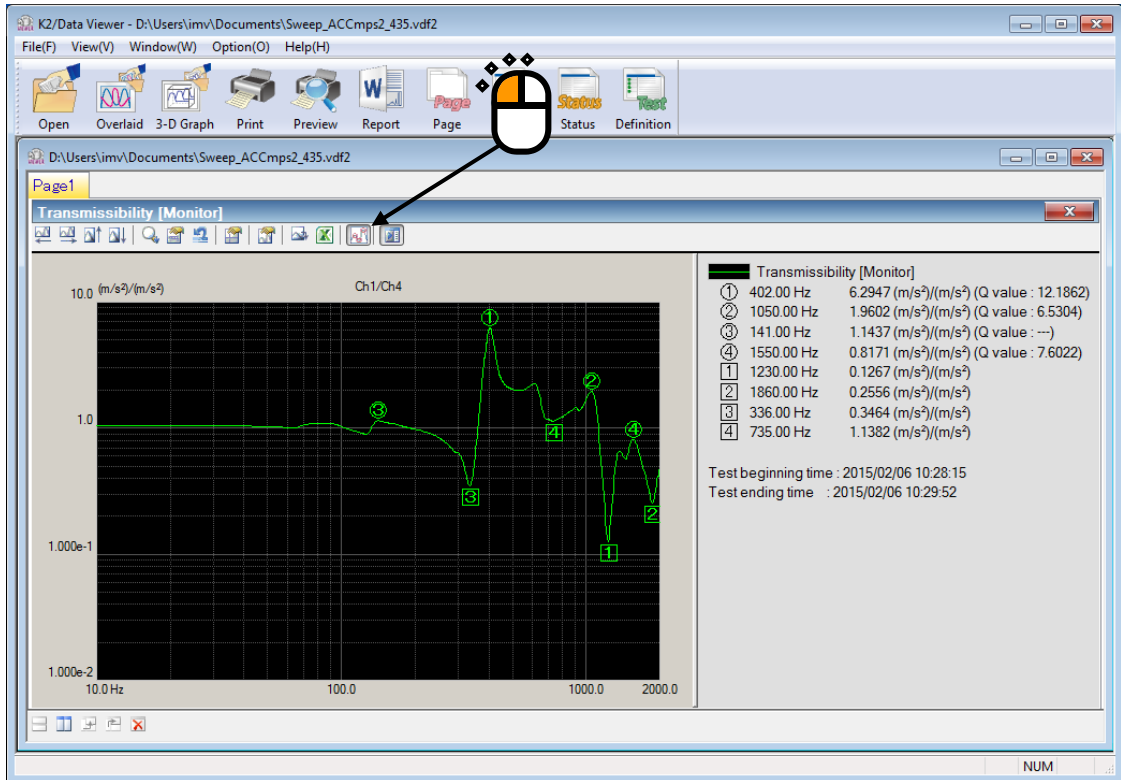

Peaks are marked with rounds, and valleys are marked with squares from the higher order.

The values appear in the legend window.

As for the peak detecting conditions, maximum number of marks, changing of display/non-display of value Q, refer to “4.3.7 Graph Color Setting”.

**Note) This button is invalid during excitation.**

**Marks displayed before excitation are deleted when excitation starts.**

### 4.3.7 Graph Color Setting

This function is for changing the setting of graph freely to be displayed.

< Procedures >

< Step 1 >

Select “Option” in the menu bar and click the “Graph color setting”.

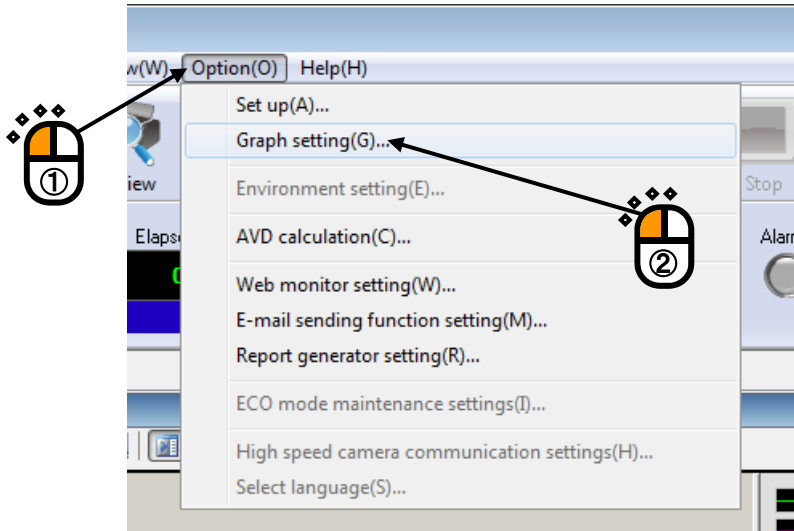

#### 4.3.7.1 Change Graph Color

Select items to be changed on the tab of “Graph color”, and change the settings of line types, marks, and colors.

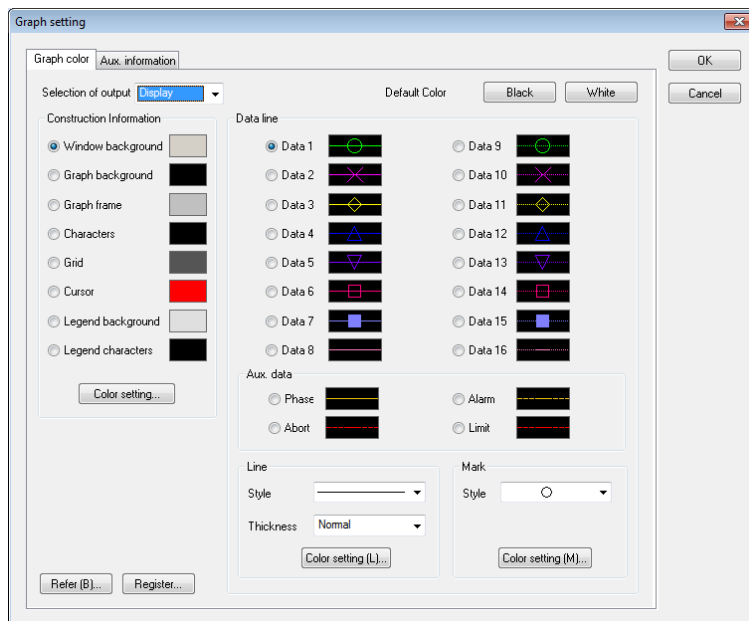

**Note)** The setting of ‘Graph color setting’ is not influenced to the setting of ‘Print color setting’. Refer to ‘Print color setting’ in “4.4 Output to the Printer” about changing the color of a graph to be printed.

### 4.3.7.2 Change of Auxiliary Information

Change the settings of display/non-display of 'Test beginning/ending time' and peak mark on the tab of 'Aux. information' tab.

After completing necessary changing, press the button of [OK].

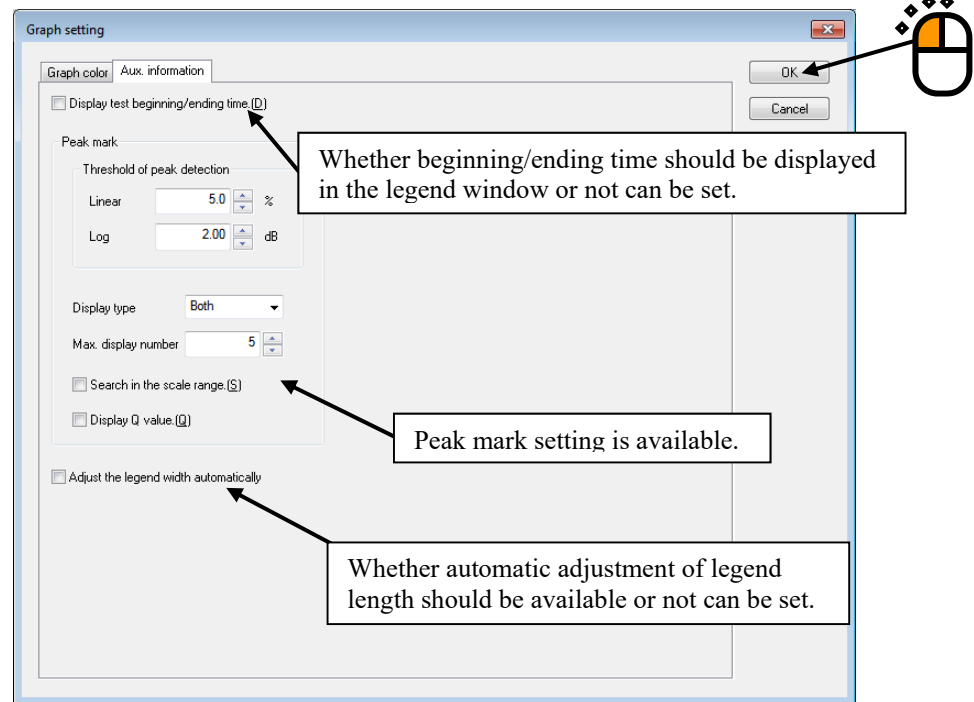

#### 4.3.7.2.1 Test Beginning/Ending Time

Whether test beginning/ending time should be displayed in the legend window or not can be set.

While a test is being executed, test beginning time is displayed when excitation is started, and test ending time is displayed when the excitation is ended.

This setting is valid for applications shown below.

SINE, RANDOM, SHOCK, RESONANCE DWELL, Multi-SWEEP SINE  
BMAC, Multi-RANDOM, Multi-SINE, BMAC with Torsion

**Note)** There may be some differences between the time displayed and that of the execution status and history.

#### 4.3.7.2.2 Peak Mark

Setting relative to peak mark is available.

< Threshold of peak detection >

Threshold to judge peak/valley can be set up.

< Display type >

Select any object to be marked among the choices of 'Maximum value/Minimum value/both'.

< Max. display number >

Maximum number of marking can be set up. ( from 1 to 10)

If detected peaks and valleys are less than it, only the detected items are marked.

< Search in the scale range >

Whether peaks and valleys should be detected in the scale range currently displayed or in all the data can be set up.

< Display Q value >

Whether Q value should be displayed with the peak value in the remark window or not can be set up.

**Note) This function is valid only in transmissibility graph.**

Q value is calculated by using the formula below.

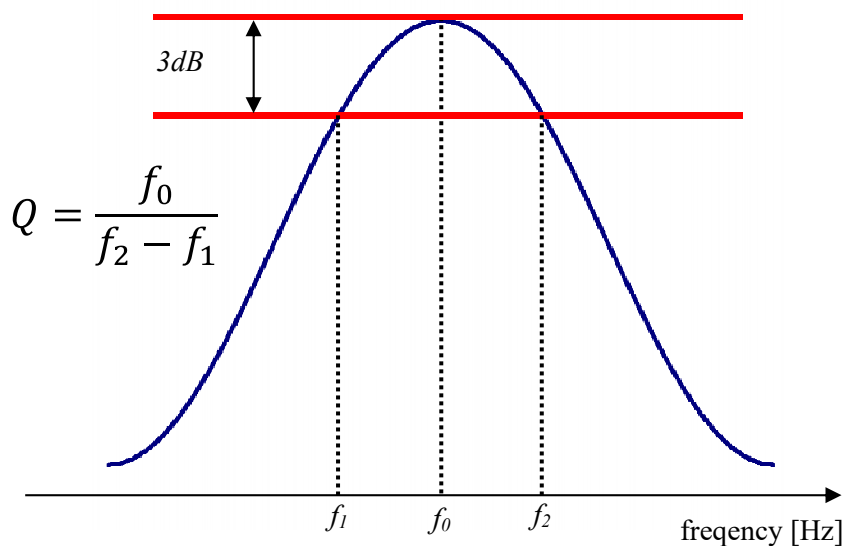

#### 4.3.7.2.3 Legend Width

Whether automatic adjustment of legend length should be available or not can be set.

### 4.3.8 Overlaid graph of two types of data

It is possible to overlay two types of graphs on one graph.

By using this function, data of different physical quantities (acceleration, force, etc.) can be overlaid.

< Procedures >

The following is the explanation of display procedures taking the overlaid graph of acceleration reference/response data and force monitor data in SINE as an Example.

< Step 1 >

Select the menu of [Window] – [Overlaid graph].

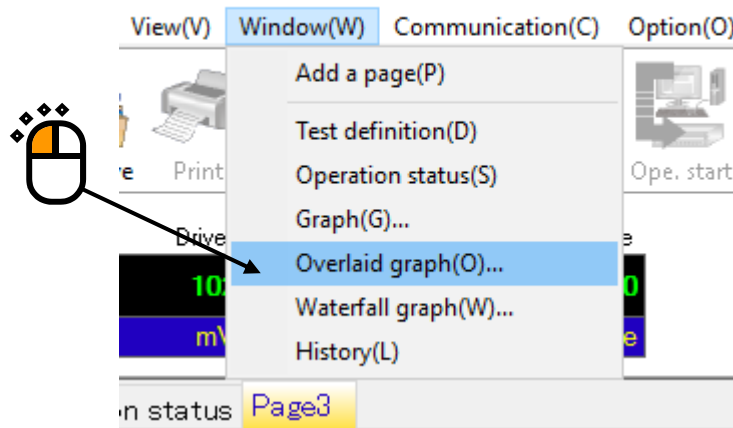

< Step 2 >

Press the [Select(1)] button and select [Resp./Ref.].

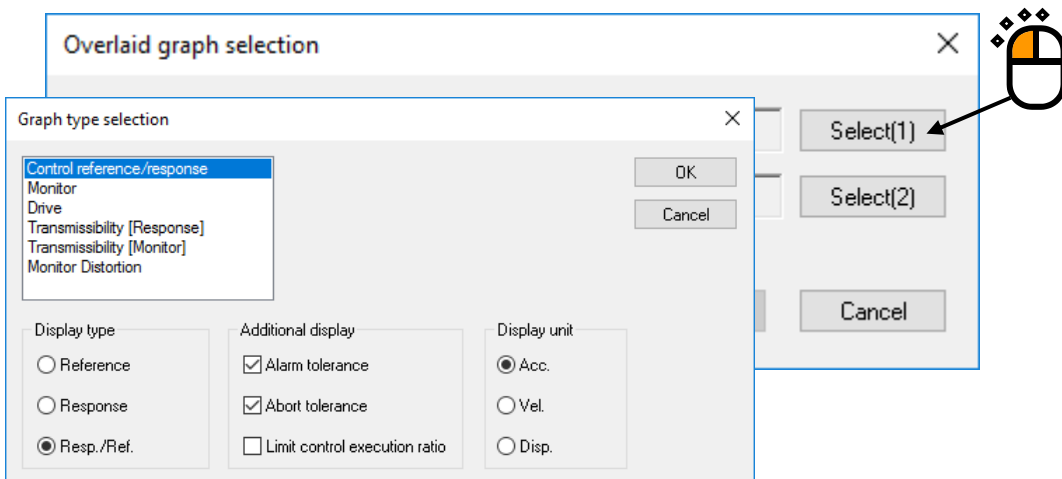



< Step 3 >

Press the [Select(2)] button and select [Monitor] and the input channel of force.

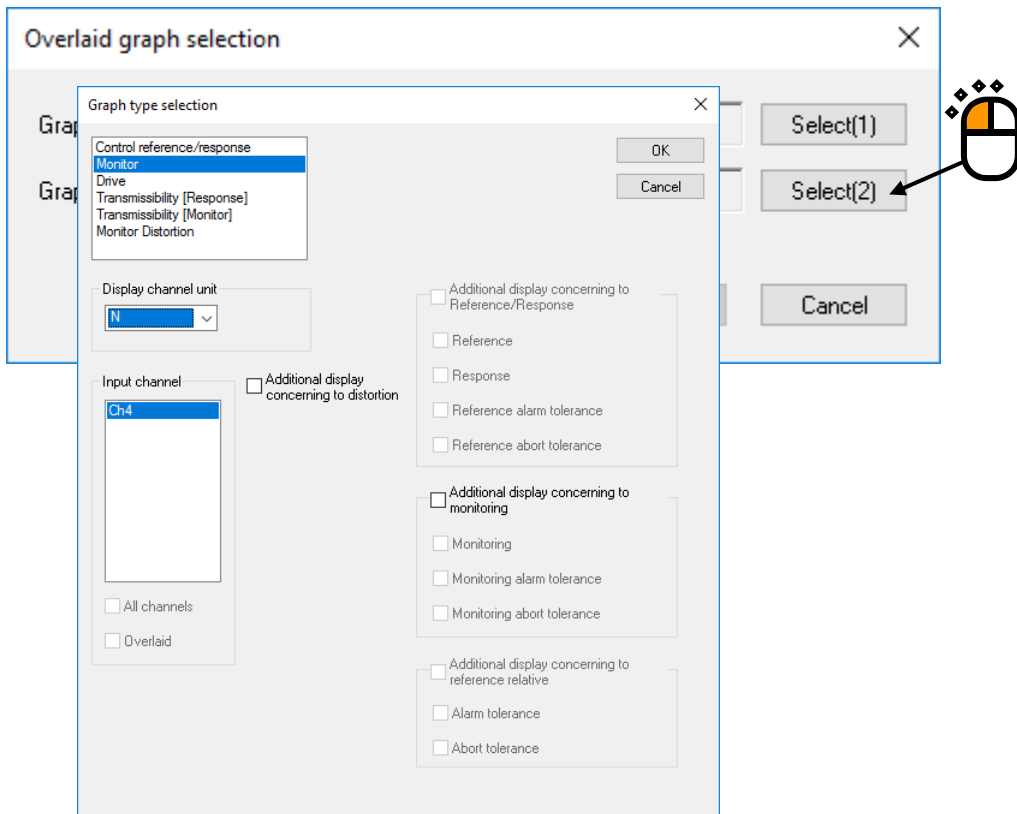

< Step 4 >

Press the [OK] button and close this screen.

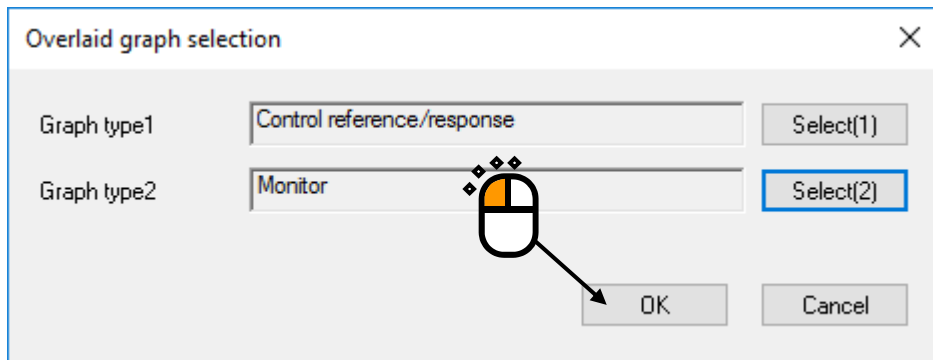

< Step 5 >

The overlaid graph of acceleration reference/response data and force monitor data is displayed.

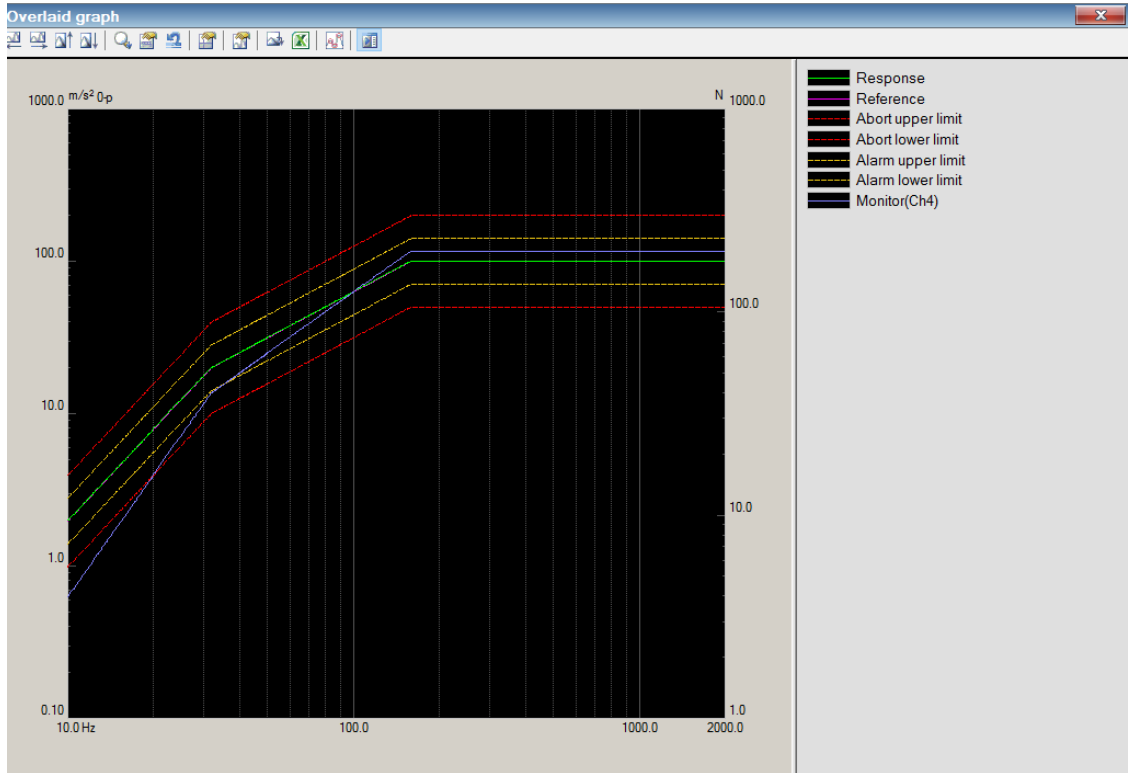

## 4.4 Output to the Printer

### 4.4.1 Print

In K2 Application, Test Definition, Graph and Log are printed out mainly by using the function of print executed by selecting “File” – “Print” in the menu bar.

The items to be printed out are available to select by clicking on it.

< Procedures >

< Step 1 >

Select “File” in the menu bar and click “Print” among the items.

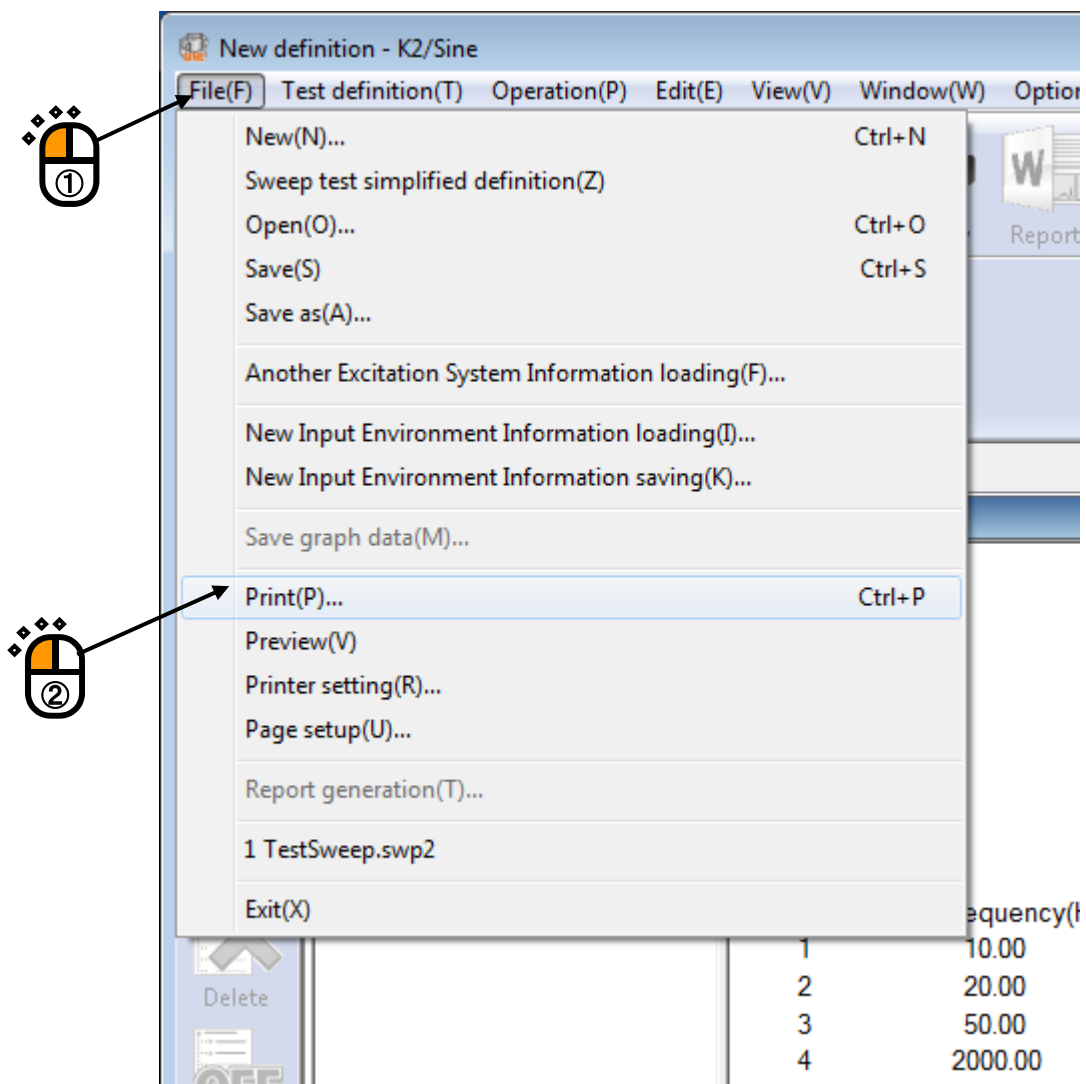

< Step 2 >

Select printer and input the setting of 'Margin Setting' and 'Header/Footer' and press [OK].

Header and footer are printed inside except the margin area. If the number of characters displayed in header and footer are too large and they cannot be displayed completely. In this case, increase the height.

When 'Print per Graph' is checked and two or more graphs are printed, one graph per each page is printed. The scale of the printed graph is the same as the scale of the displayed graph.

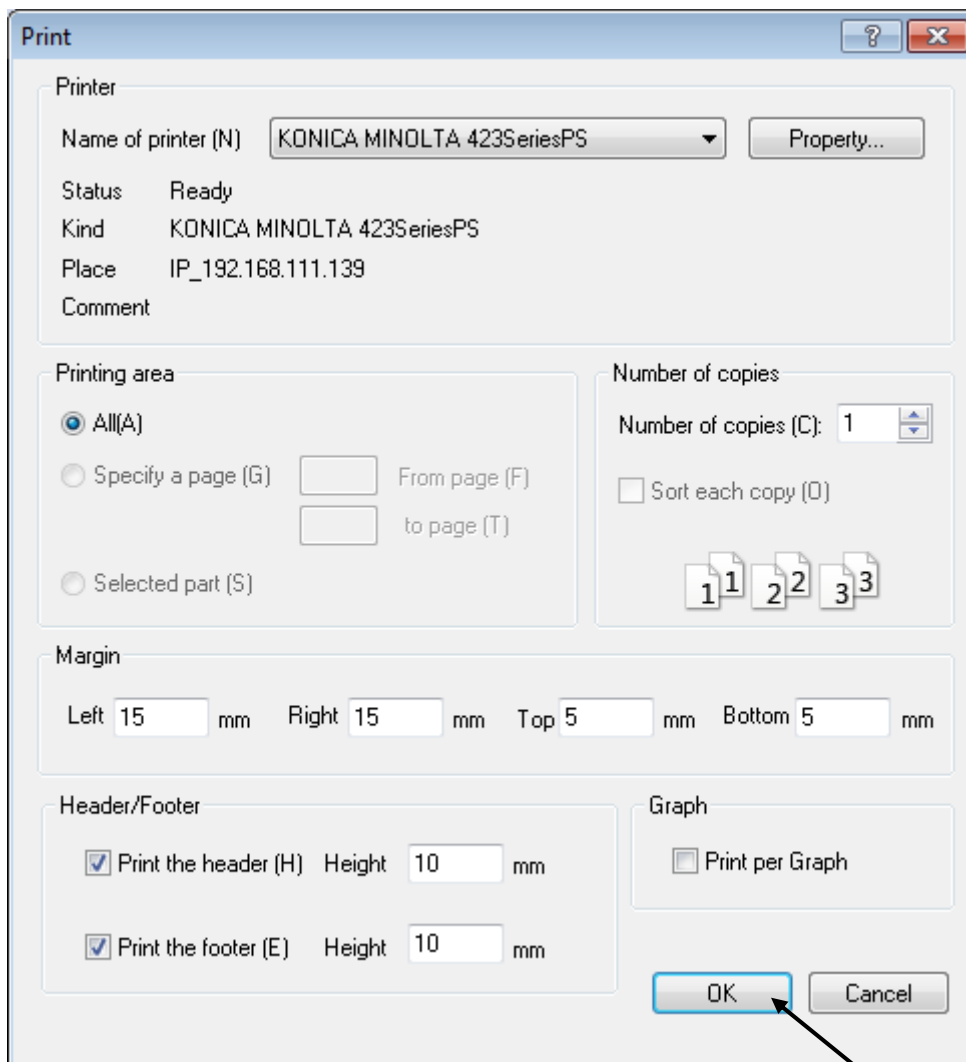

#### 4.4.2 Printer Setting

This item is for defining of margin setting, setting of footer/header and date printing for the printer.

< Procedures >

< Step 1 >

Select “File” in the menu bar and click “Printer setting” among the items.

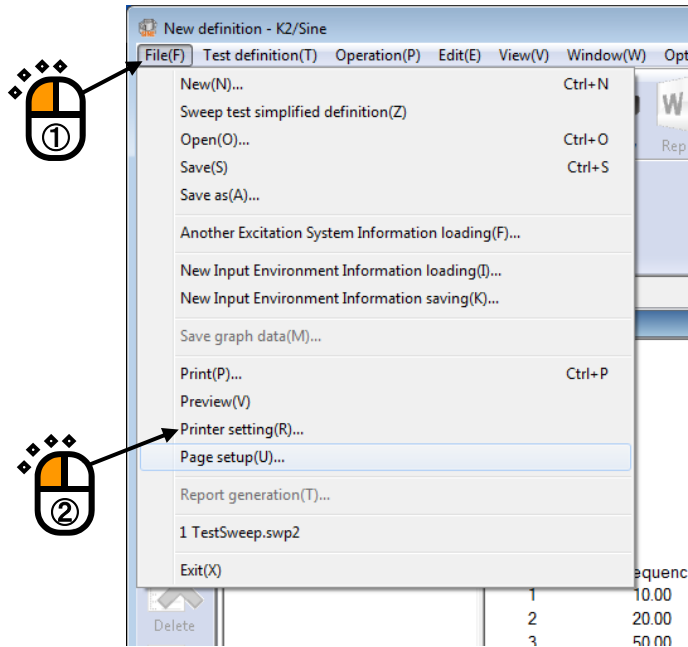

< Step 2 >

Select the printer to be used, setup, paper size, and Orientation, and press [OK] button.

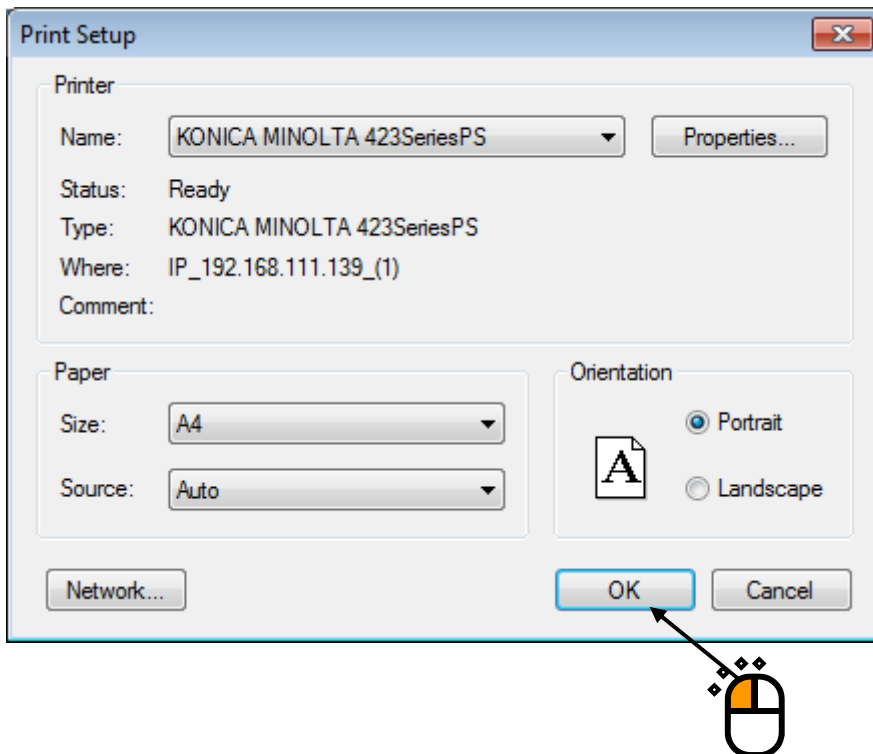

### 4.4.3 Page setup

Print margin can be set up.

< Procedures >

< Step 1 >

Select “File” in the menu bar and click “Page setup” among the items.

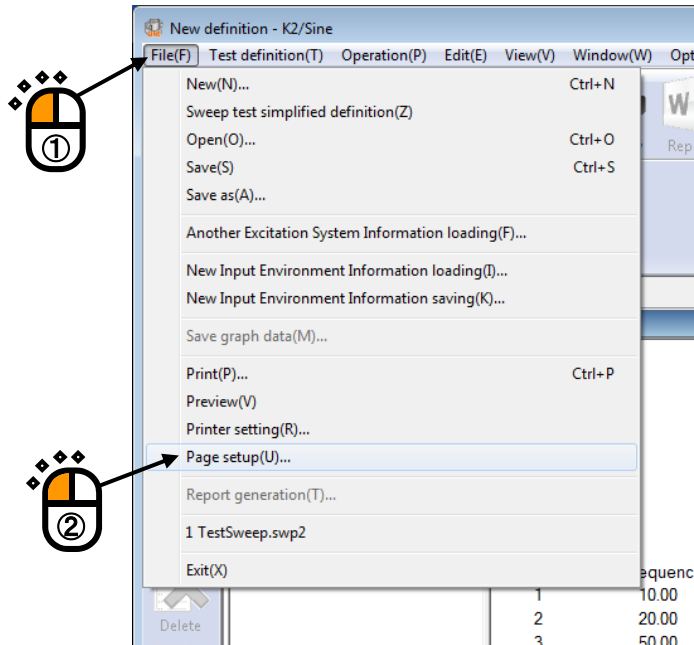

< Step 2 >

Input the setting of ‘Margin Setting’ and ‘Header/Footer’ and press [OK].

Header and footer are printed inside except the margin area. If the number of characters displayed in header and footer are too large and they cannot be displayed completely. In this case, increase the height.

When ‘Print per Graph’ is checked and two or more graphs are printed, one graph per each page is printed. The scale of the printed graph is the same as the scale of the displayed graph.

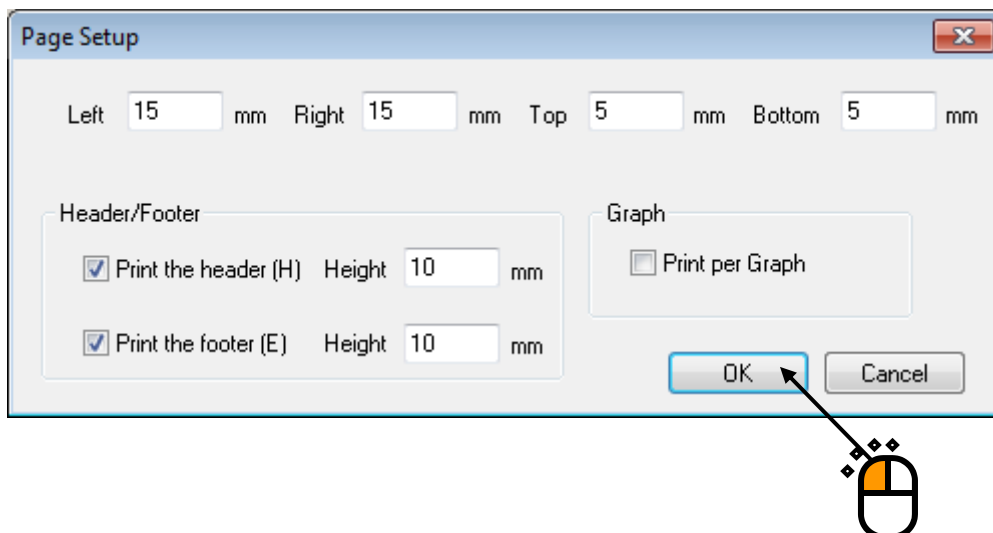

#### 4.4.4 Print Color Setting

This item is for setting of the graph display type of data line, color and mark at printing.

< Procedures >

< Step 1 >

Select “Option” in the menu bar and click “Graph setting” among the items.

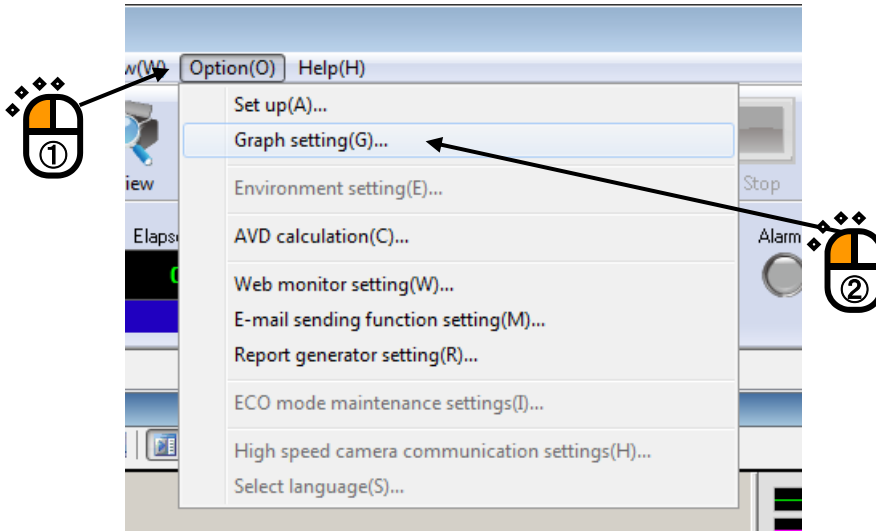

< Step 2 >

Select “Printer” from “Selection of output” in the graph color setting tab.

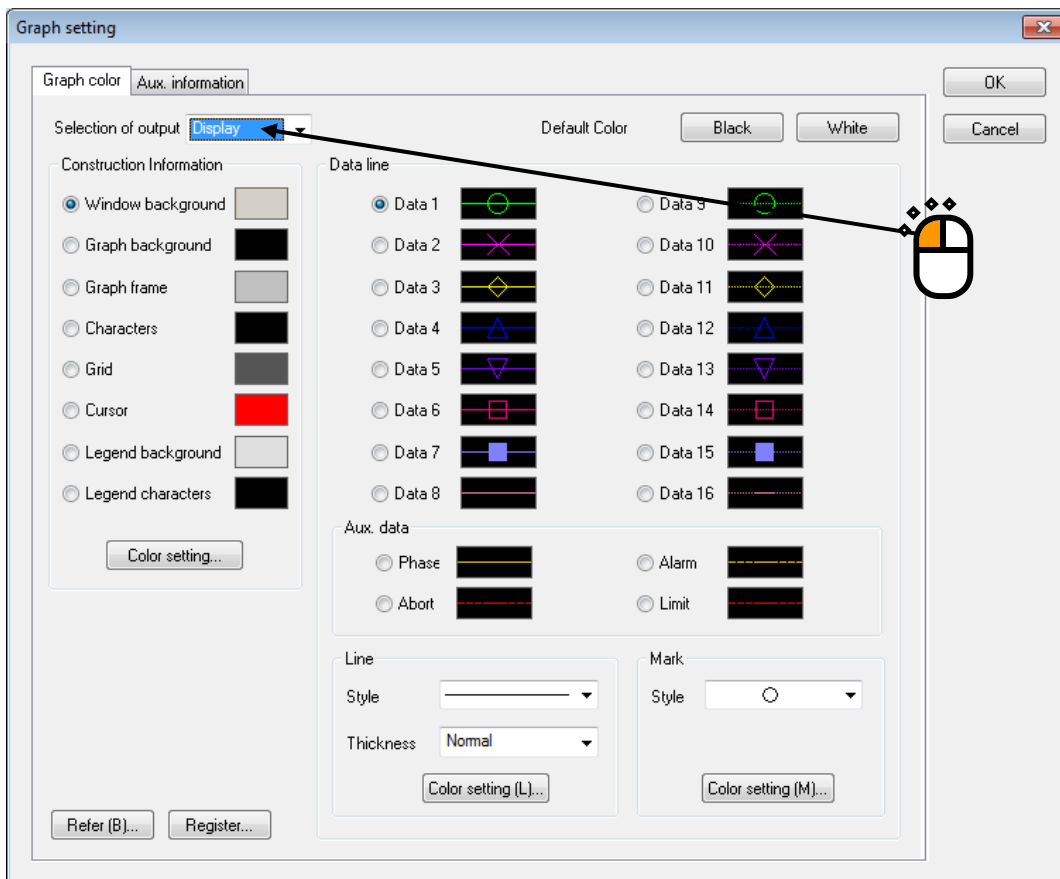

< Step 3 >

Select the data line and the color etc..

Then press [OK] to complete the setting.

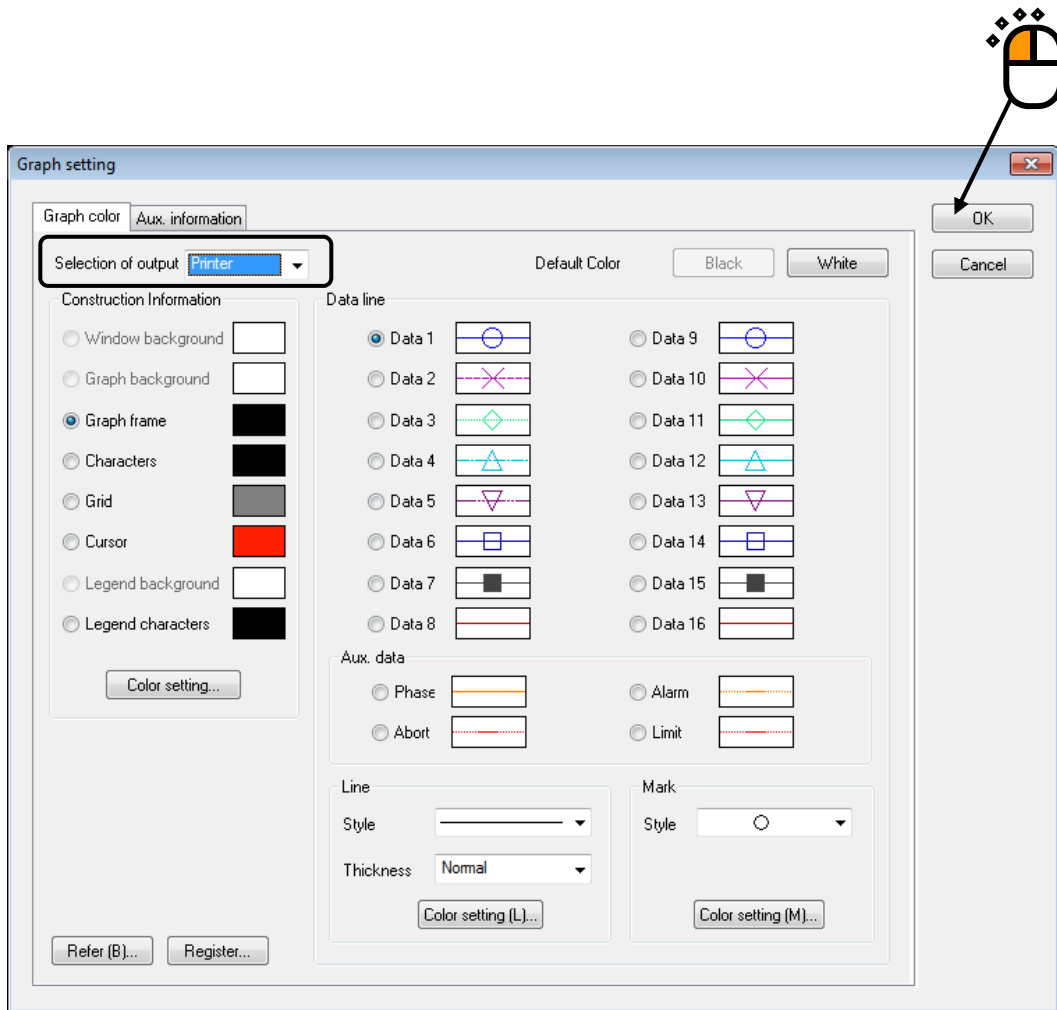

**Note) Printer may not work correctly when the setting of 'Printer type' is not set correctly.**



## 4.5 File Conversion

### 4.5.1 File conversion to CSV

This function is for converting a data file of K2 file format to that of CSV file format.

< Procedures >

< Step 1 >

Click a [Save Data] button on the graph display window.

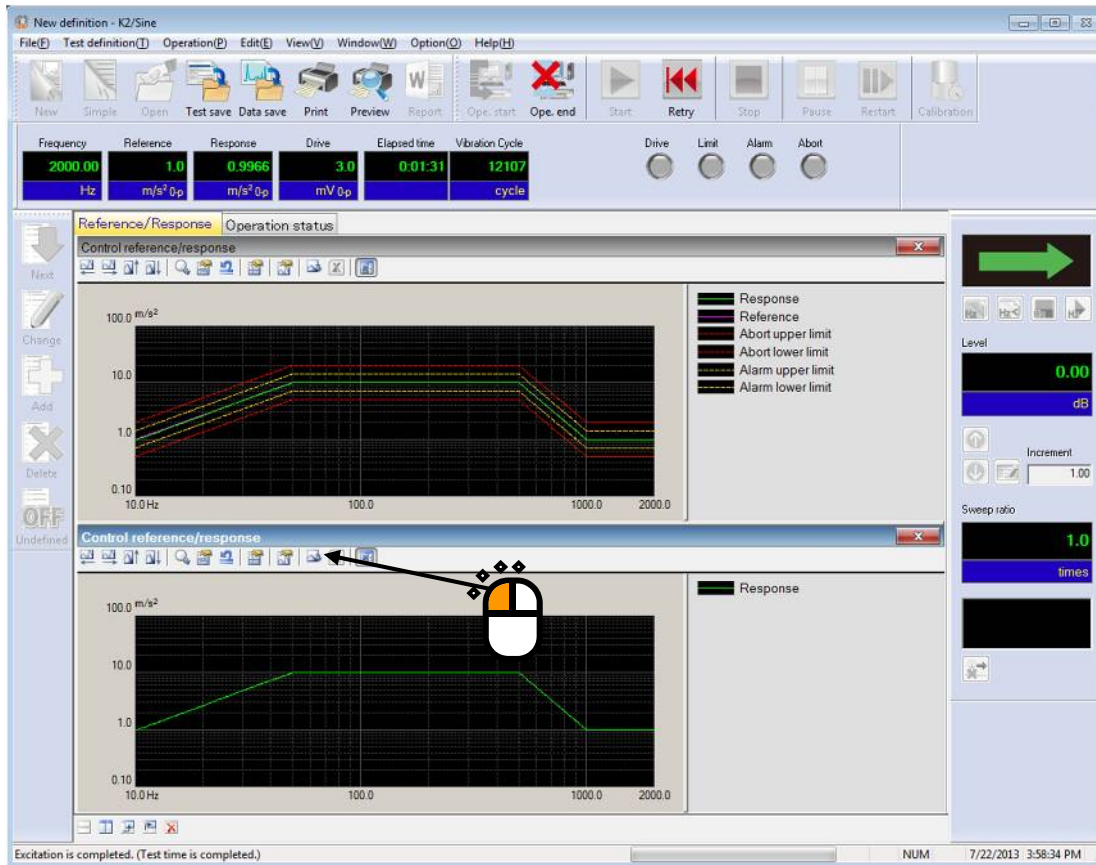

< Step 2 >

Show the Data Save window and Input a file name of CSV and press [Save].

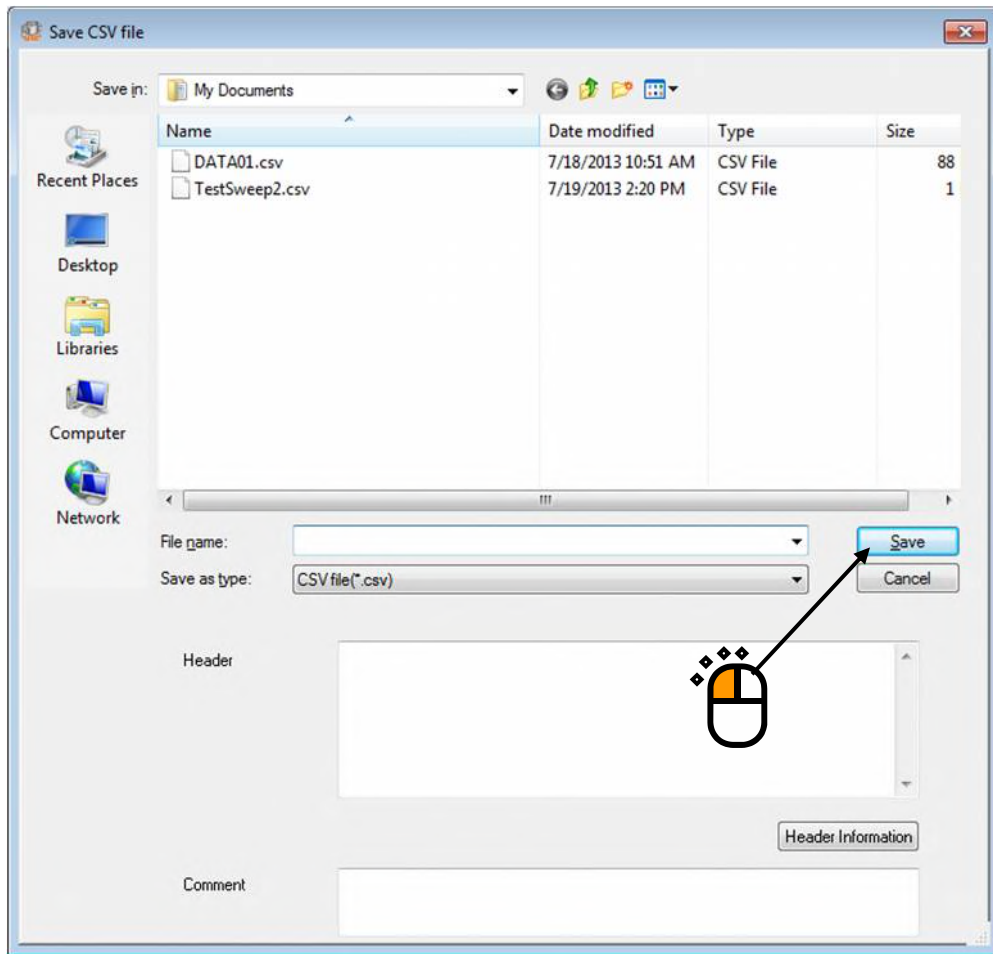

**Conversion of SINE Reference/Response Data (with Tolerance)**

	1st. column	2nd. column		
1st. line	<i>Frequency[Hz]</i>	<i>Response[unit]</i>	<i>Reference[uni]</i>	<i>Abort upper limi[uni]</i>
2nd. line	***.***,	***.***,	***.***,	***.***,
	***.***,	***.***,	***.***,	***.***,
	***.***,	***.***,	***.***,	***.***,
	:	:	:	:
	***.***,	***.***,	***.***,	***.***,

- Fixed characters are written in Italic.
- Data name of graph is substituted for a data name.
- Unit of graph is substituted for a unit.
- Frequency data is substituted in the 1st. column.
- Each data is substituted from the 2nd. column.

### Conversion of RANDOM Spectrum Data

	1st. column	2nd. column	3rd. column		
1st. line	<i>Frequency[Hz]</i>	Data name 1[ <i>unit</i> ]	Data name 2[ <i>unit</i> ]	Data name 3[ <i>unit</i> ]	.....
2nd. line	***.***,	***.***,	***.**,	***.**,	.....
	***.***,	***.***,	***.**,	***.**,	.....
	***.***,	***.***,	***.**,	***.**,	.....
	:	:	:	:	:
	***.***,	***.***,	***.**,	***.**,	.....

- Fixed characters are written in Italic.
- Data name of graph is substituted for a data name.
- Unit of graph is substituted for a unit.
- Frequency data is substituted in the 1st. column.
- Spectrum data is substituted from the 2nd' column.

### Conversion of SHOCK Waveform Data

	1st. column	2nd. column	3rd. column		
1st. line	<i>Time[ms]</i>	Data name 1[ <i>unit</i> ]	Data name 2[ <i>unit</i> ]	Data name 3[ <i>unit</i> ]	.....
2nd. line	***.***,	***.***,	***.**,	***.**,	.....
	***.***,	***.***,	***.**,	***.**,	.....
	***.***,	***.***,	***.**,	***.**,	.....
	:	:	:	:	:
	***.***,	***.***,	***.**,	***.**,	.....

- Fixed characters are written in Italic.
- Data name of graph is substituted for a data name.
- Unit of graph is substituted for a unit.
- Time data is substituted in the 1st. column.
- Each data is substituted from the 2nd' column.

#### 4.5.2 Graph display on Excel

This function is for displaying graphs on Excel by converting the data file in K2 file format to in the excel file format.

This function requires Microsoft® Excel software installed.

Note) This program supports only for Microsoft® Excel 2010, Microsoft® Excel 2013 , Microsoft® Excel 2016 and Microsoft® Excel 2019.

< Procedures >

< Step 1 >

Select a graph to be converted and displayed on Excel.

Press the button of [Output the graph to Excel] in the graph display dialog of K2.

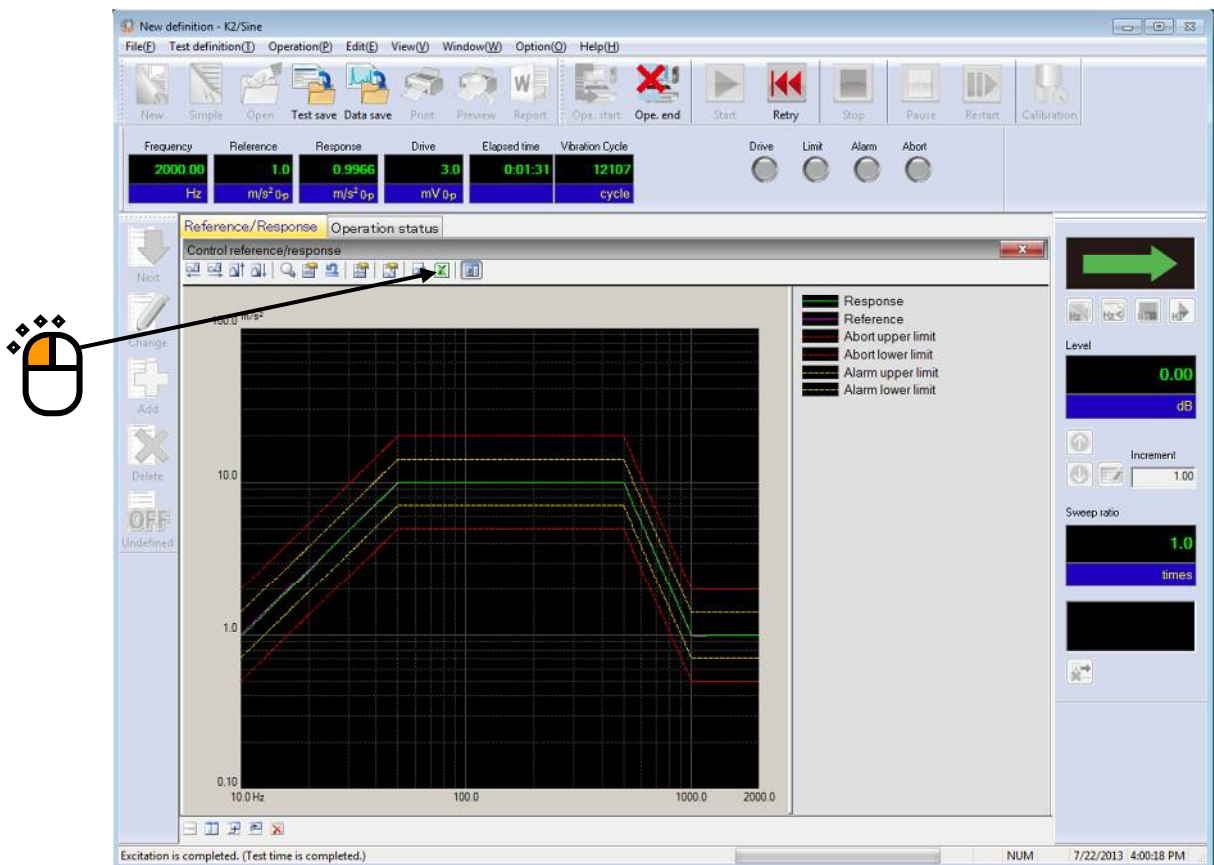

Excel software is started up to display the selected graph in the excel format.

## 4.6 Selecting languages (option)

This function is optional.

This function selects the language for K2 application display.

The language used for saved data files cannot be switched.

\* 'Japanese, English, Chinese, Russian or German' can be selected (as of October 29, 2015).

Response statuses of respective K2 applications are varied.

< Operating procedure >

< Step 1 >

Select "Option" from the menu bar and click "Select Language".

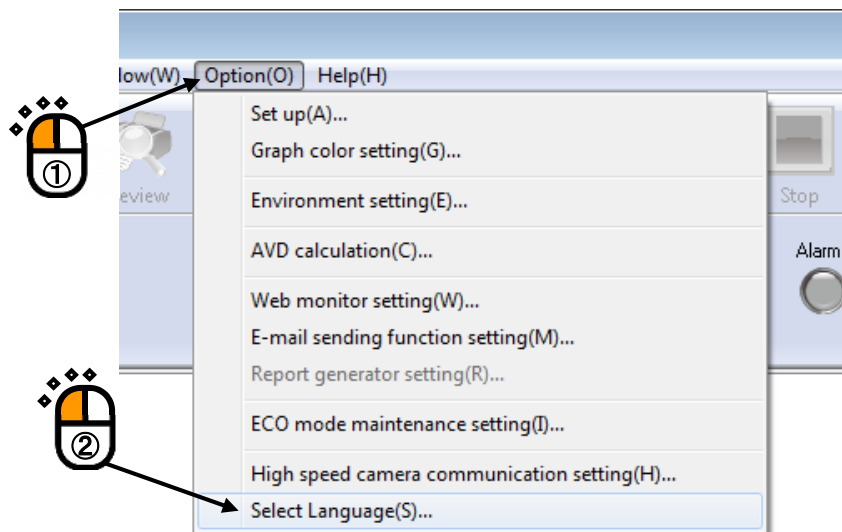

< Step 2 >

Select a language, and then press the [OK] button.

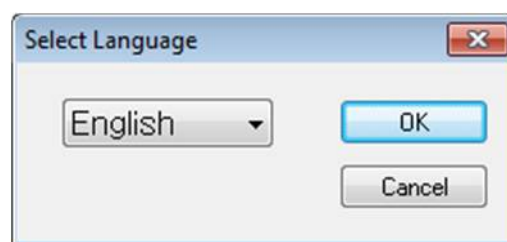

The following message appears. The current language will be switched on application restarting.

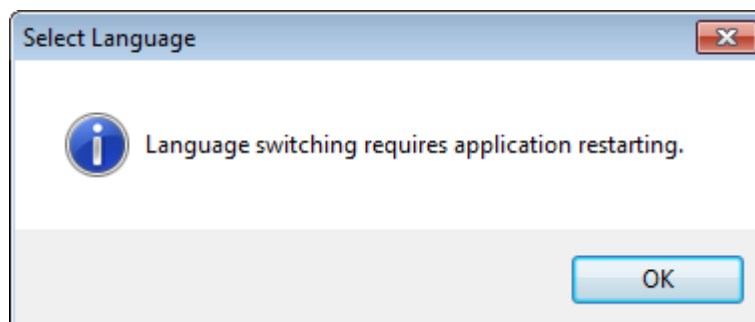

## 4.7 Test Definition File

It describes that each data saved in Test Definition file (Live Data in Operation, Excitation system information, Input environment information).

### 4.7.1 Saving Live Data in Operation

The state at the test abort (completed), that is, a data necessary for the test is to be recorded by saving its Test Definition file of the state at excitation completed.

Press the icon of [Save] in the state at excitation completed. A dialog box as below appears if there is a data to be recorded to a test in the state at excitation completed. Available items in this dialog vary according to the reason or condition at excitation completed.

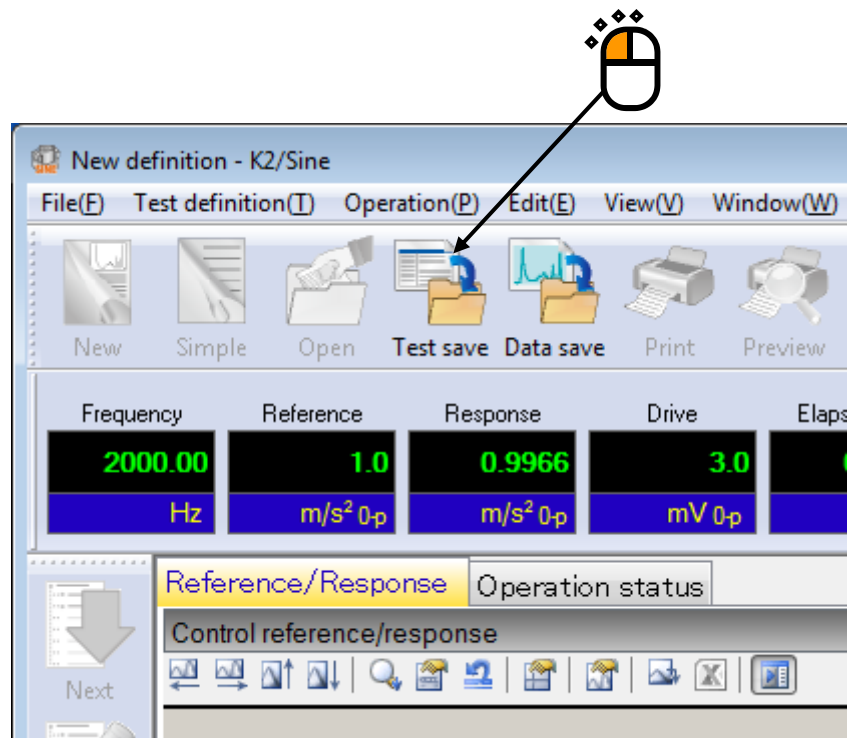

Example Display at Excitation Completed

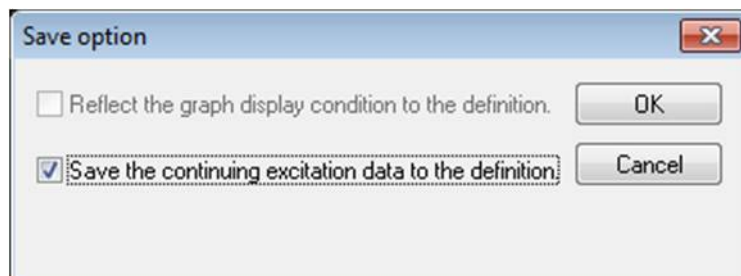

Save option

#### 4.7.2 Deleting of Testing Operation Relational Data

You have the merit and the demerit as below at acquiring and saving the testing operation relational data in a Test Definition file.

##### [Merit]

- The state at the test completion is to be checked again after the test completion.
- Excitation operation is to be restarted from the state at excitation completed.

##### [Demerit]

- Test Definition contents cannot be changed until the Live Data in Operation is deleted.

To delete the testing operation relational data, follow the steps below.

< Procedures >

< Step 1 >

Press the button of [Delete] by selecting Relational Data.

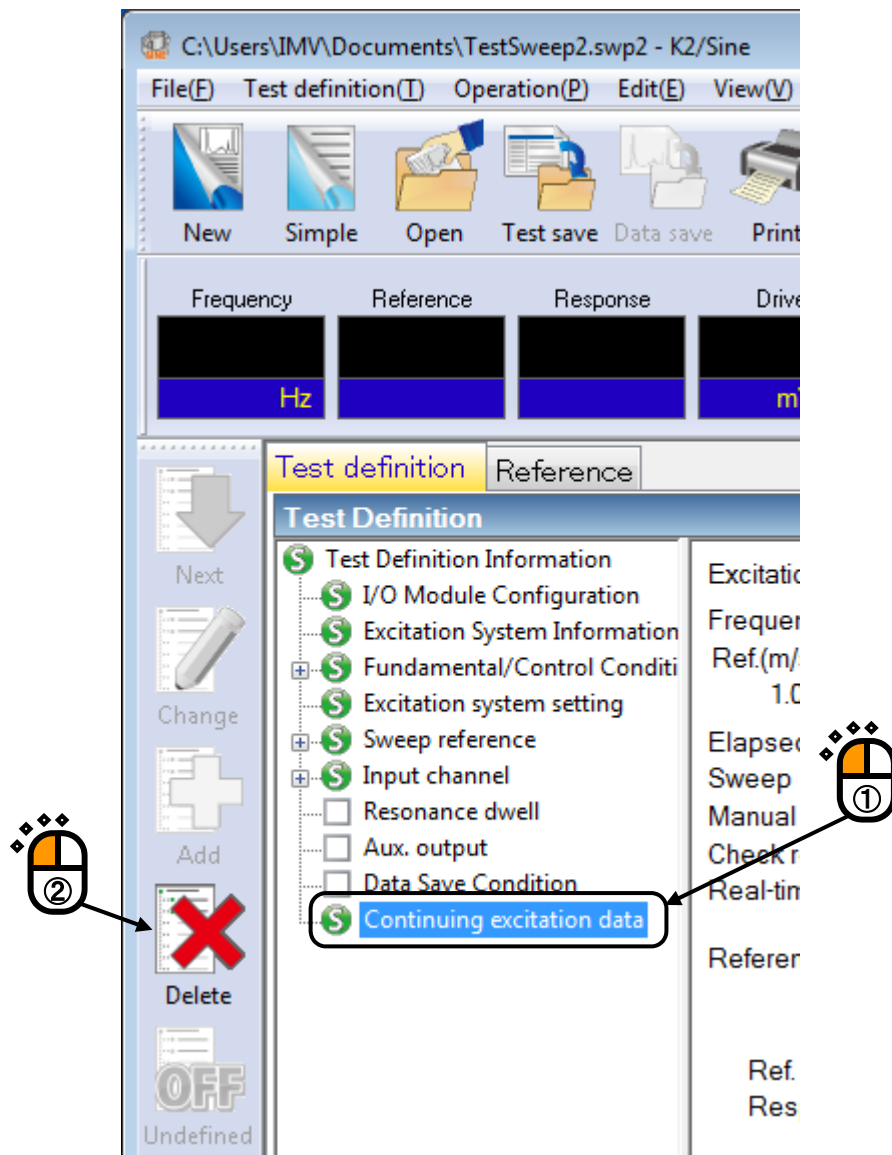

< Step 2 >

Press [Yes] when a dialog of message for assuring appears.

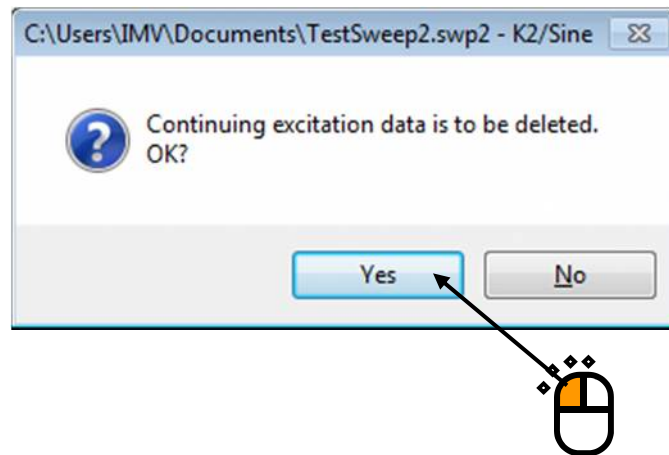



### 4.7.3 Another Excitation System Information loading

This item is for changing the excitation system information registered in Test Definition file to another.

< Procedures >

< Step 1 >

Select “File” in the menu bar and click “Another excitation system information loading” among the items.

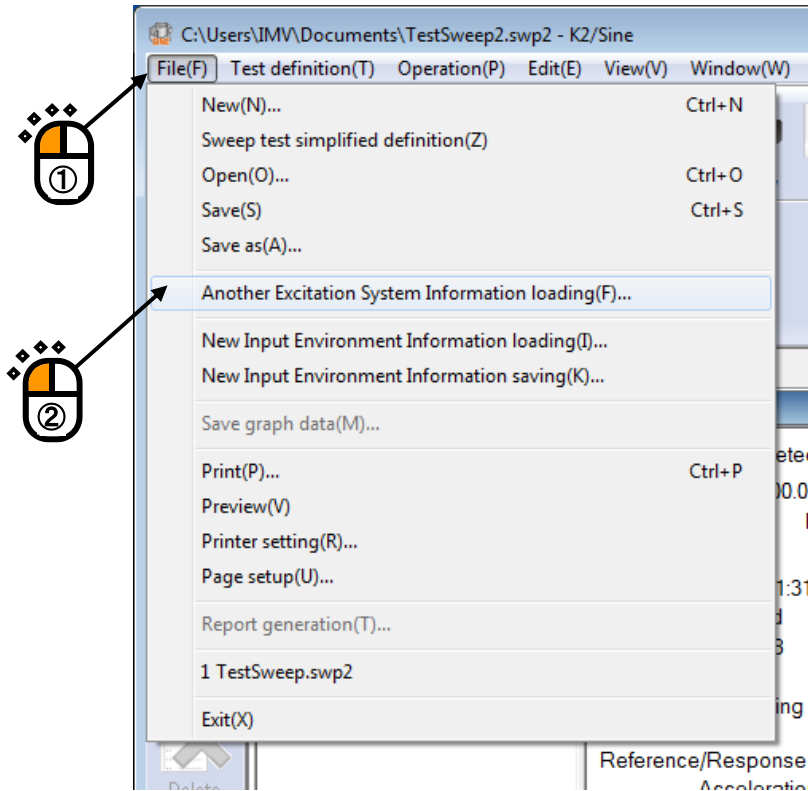

< Step 2 >

Select ‘Excitation system information name’ to be registered in Test Definition File and press [OK].

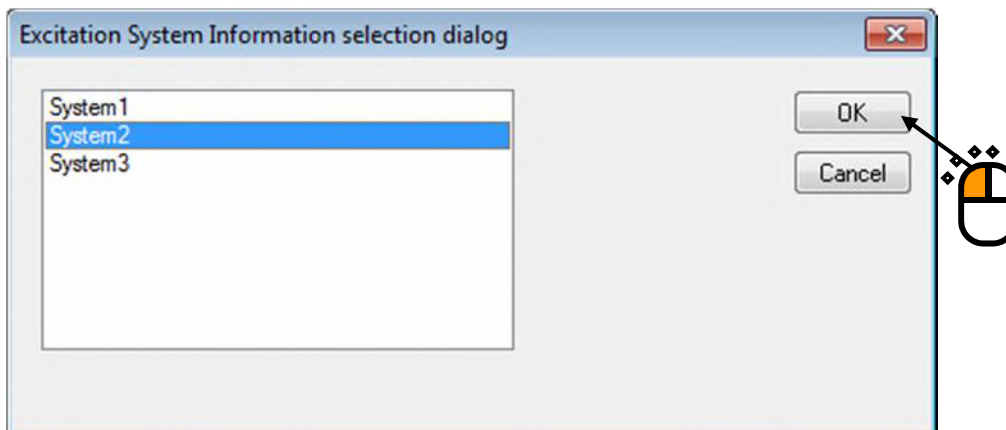

< Step 3 >

The corrected server name and Excitation system information name are displayed. Press [Save] to overwrite the Test Definition file.

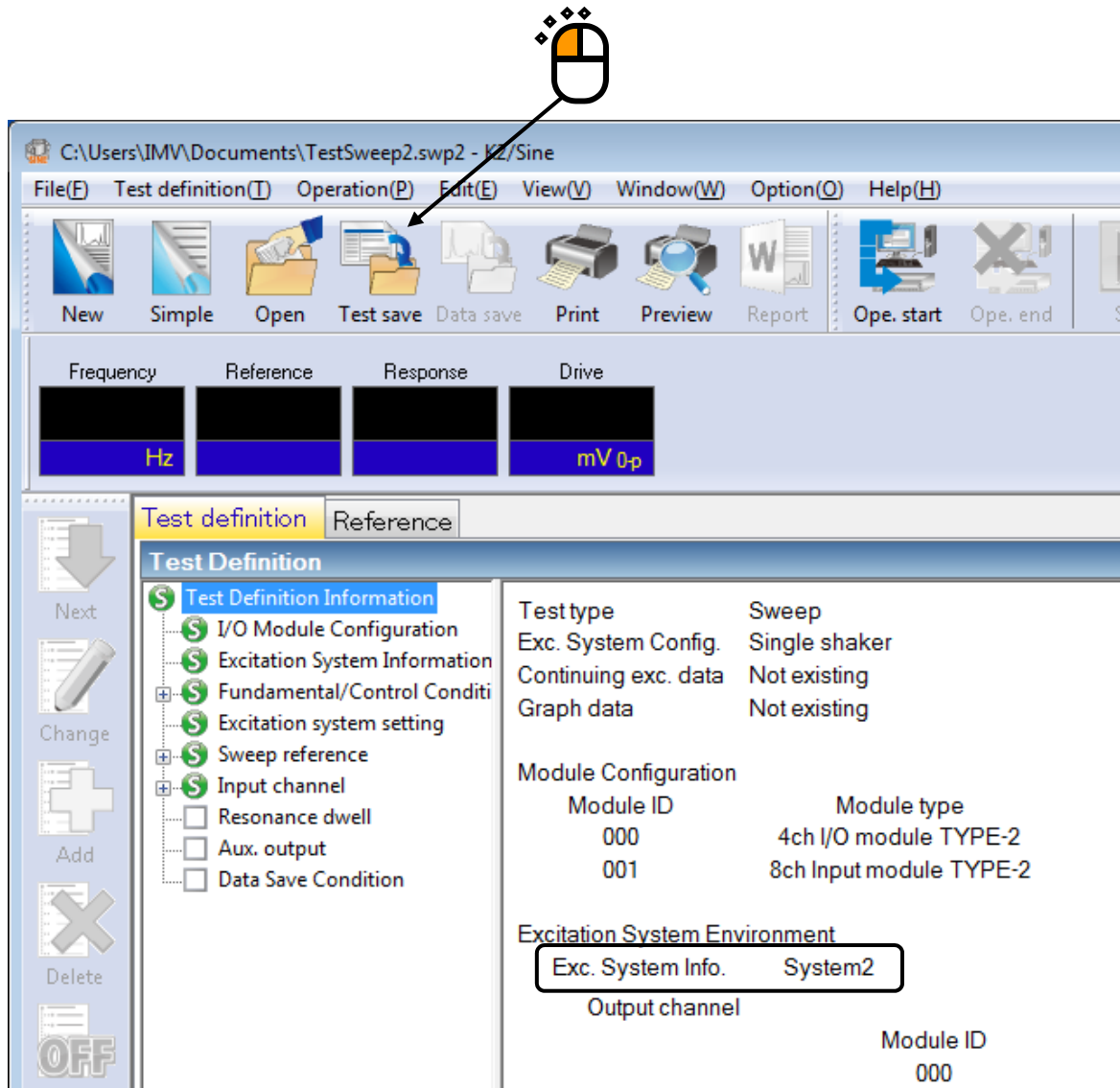

#### 4.7.4 Input Environment Information

Input environment information is used for simplifying of the input sensitivity setting for a sensor.

When Input environment information is used for the setting, addition/correction of an input channel is also available during the test definition.

#### 4.7.5 New Input Environment Information Loading

Input channel information is available to load newly from the input channel information registered in Environment setting.

< Procedures >

< Step 1 >

Select “File” from the menu bar and click “New Input environment information loading” among the items.

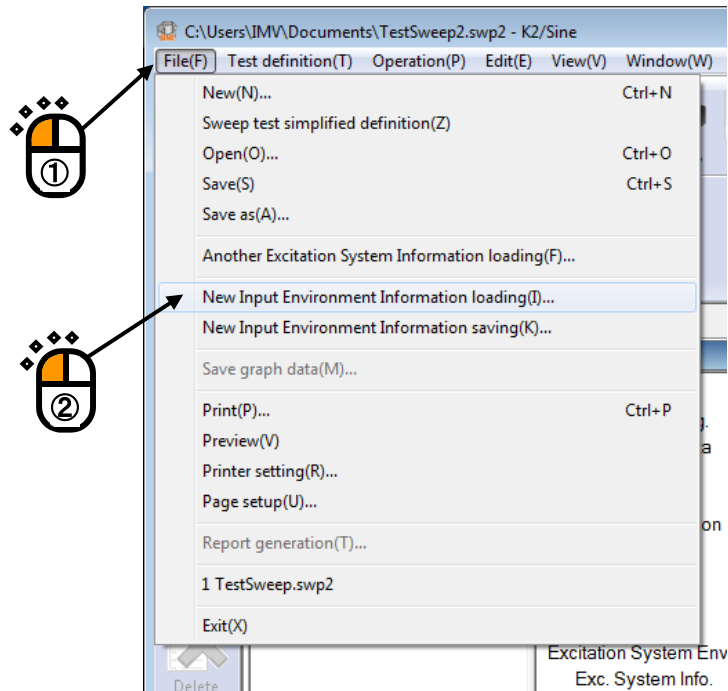

< Step 2 >

Press [OK] by selecting an Input environment information to be used.

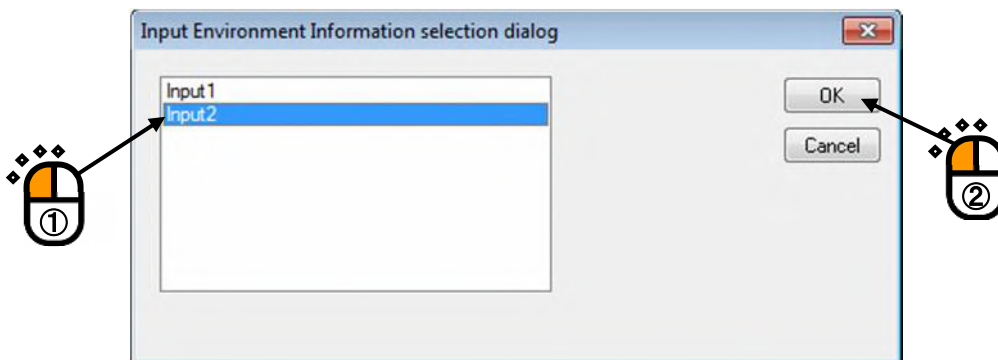

#### 4.7.6 New Input Environment Information Saving

The setting of input environment used in Test Definition is available to be registered in Environment setting as Input channel information.

< Procedures >

< Step 1 >

Select “File” in the menu bar and click “New Input environment information saving” among the items.

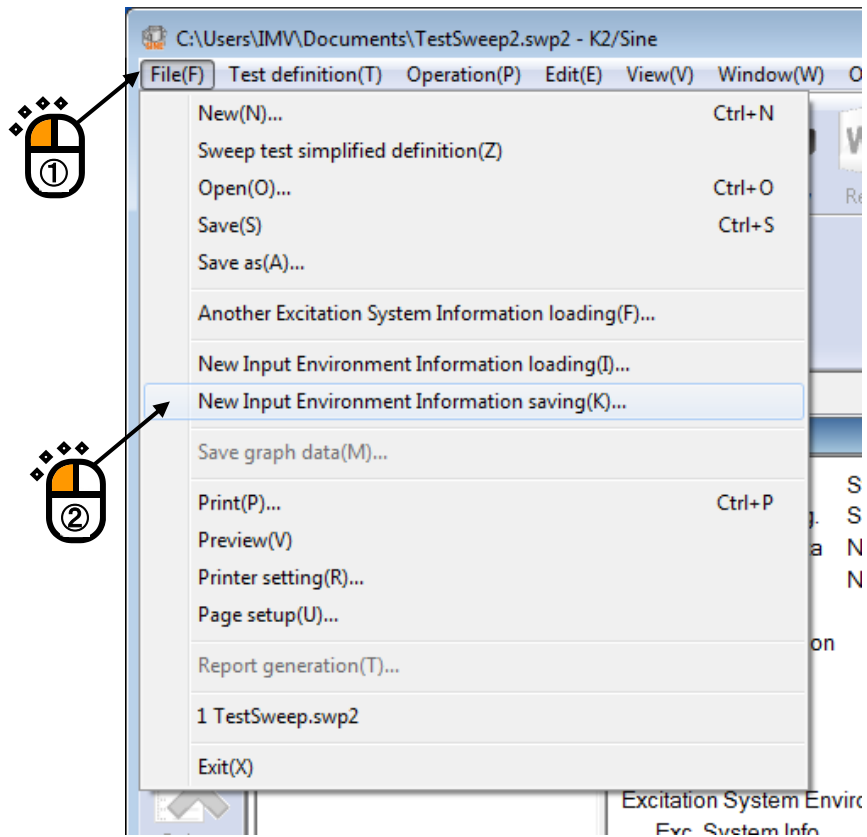

< Step 2 >

Press [OK] by inputting the name of Input environment information.

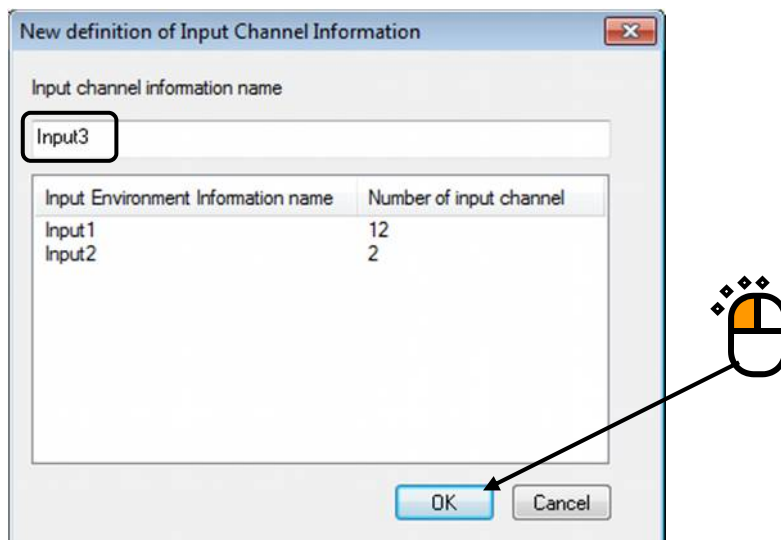

## 4.8 Contact I/O Information

### 4.8.1 Outline

It describes about the definition method of input/output signal configuration to the contact I/O port set to I/O Unit.

The contents of Contact I/O signal function is ordinary specified for each application program individually. However, in this system, the user can flexibly define the use/not use and the port configuration of contact I/O signals according to the specifications.

Definition of this item is not necessary to be defined when Contact I/O function is not used.

Contact I/O ports are set to the 50 pin connectors arranged on the backside panel of I/O Unit.

Configuration of pin connectors is described as below;

Input terminal 8-bits, Output terminal 8-bits are available.

Additionally, terminals for A contact and B contact are also available for each output terminal.

25	24	23	22	21	20	19	18	17	16	15	14	13	12	11	10	9	8	7	6	5	4	3	2	1
STOP+	O8A	O7A	O6A	O5A	O4A	O3A	O2A	O1A	O8B	O7B	O6B	O5B	O4B	O3B	O2B	O1B	I8-	I7-	I6-	I5-	I4-	I3-	I2-	I1-
STOP-	O8A	O7A	O6A	O5A	O4A	O3A	O2A	O1A	O8B	O7B	O6B	O5B	O4B	O3B	O2B	O1B	I8+	I7+	I6+	I5+	I4+	I3+	I2+	I1+
50	49	48	47	46	45	44	43	42	41	40	39	38	37	36	35	34	33	32	31	30	29	28	27	26

Configuration of signals for each I/O terminal depends on the user in this system. And it is to be defined by the procedures described as below.

## 4.8.2 Contact I/O setting

Contact I/O information is to be set in **Excitation system information** of Environment setting beforehand when an external equipment and K2 system are always connected in a combined test.

You don't have to define the contact I/O information every time at generating a test when you use the function described in this clause.

< Procedures >

< Step 1 >

Select "Option" in the menu bar and click "Environment setting" among the items.

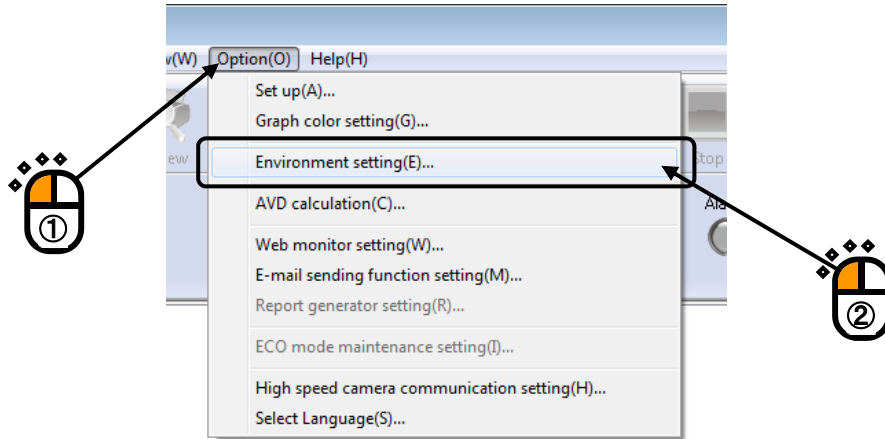

< Step 2 >

Select an Excitation system information for setting of Contact I/O information and click the [Change] button.

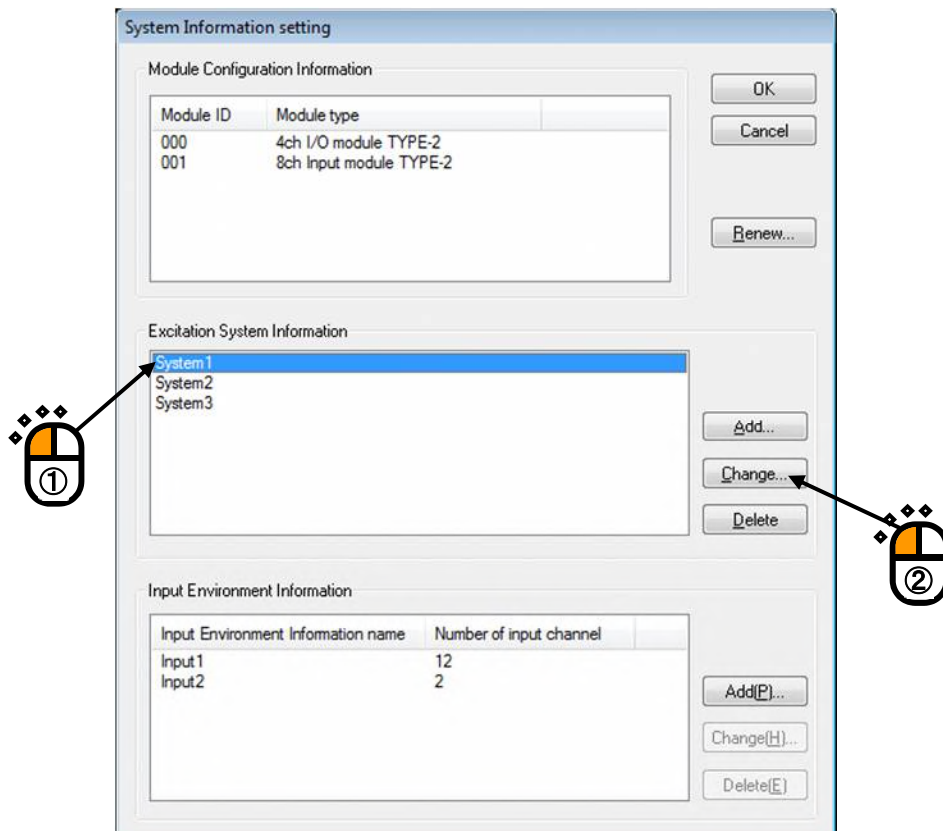

< Step 3 >

Press the [Define] button of Contact I/O information.

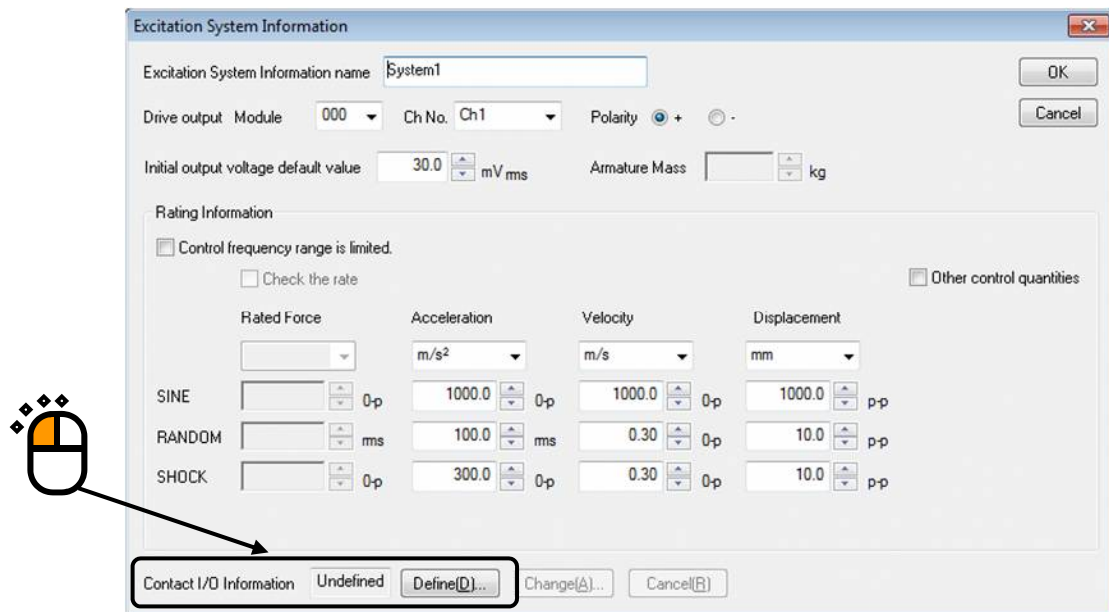

< Step 4 >

Operate the setting of Contact I/O and press [OK].

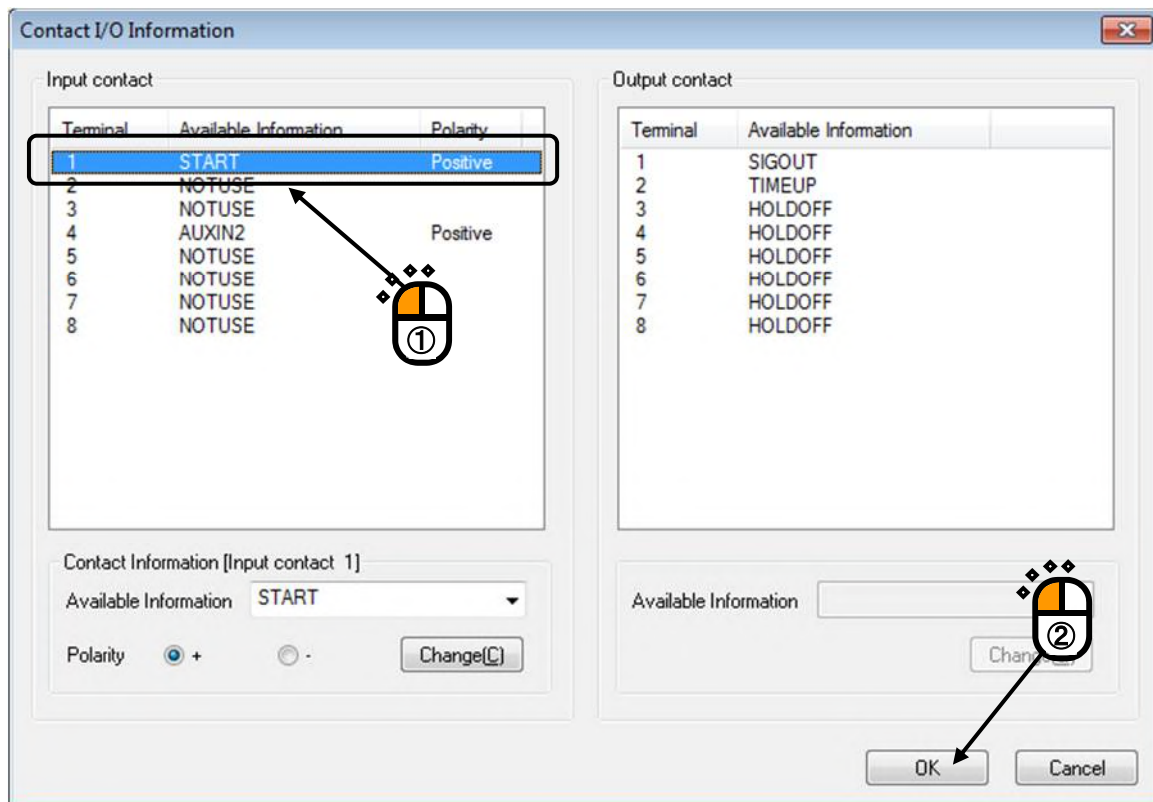

< Step 5 >

Press the [OK] button.

Excitation System Information

Excitation System Information name System1

Drive output Module 000 Ch No. Ch1 Polarity + -

Initial output voltage default value 30.0 mV rms Armature Mass kg

Rating Information

Control frequency range is limited.

Check the rate  Other control quantities

	Rated Force	Acceleration	Velocity	Displacement
SINE	0-p	1000.0 m/s <sup>2</sup> 0-p	1000.0 m/s 0-p	1000.0 p-p
RANDOM	ms	100.0 ms	0.30 0-p	10.0 p-p
SHOCK	0-p	300.0 0-p	0.30 0-p	10.0 p-p

Contact I/O Information Defined Define(D)... Change(A)... Cancel(R)



### 4.8.3 Contact I/O signal Setting

#### Input Part

Name	Order
NOTUSE	The specified terminal is not used.
RMTENB	<p>This item is for setting of an allowance of remote control for a contact state before the initial measurement.</p> <p>Valid : one time only before the initial measurement</p> <p>Default : Remote control is always allowed.</p>
SYSRDY	<p>This item is for setting of Excitation system to be available to operate.</p> <p>Valid : in all the state of test operation mode</p> <p>Default : Excitation system is always available to operate.</p>
START	<p>This item is for starting of excitation, XFR measurement or data acquisition.</p> <p>Valid : in the state of waiting for operation start, for XFR measurement start or for data acquisition start</p> <p>Default : no order</p>
STOP	<p>This item is for stopping of excitation, XFR measurement or data acquisition.</p> <p>Valid : in the state of executing the operation, operating XFR measurement or acquiring the data</p> <p>Default : no order</p>
PAUSE	<p>This item is for pausing of the excitation at 'closed'.</p> <p>And this item is for canceling the paused state and continuing the excitation at 'opened'.</p> <p>Valid : the state in operation</p> <p>Default : no order</p> <p>Available software : SINE, RANDOM</p>
DCAN	<p>This item is for canceling all input data and stopping the renewal operation of control loop at 'closed'. (for this result, checking operation such as tolerance check are not executed.)</p> <p>And this item is for canceling the valid state of this item and restarting the loop renewal operation at 'opened'.</p> <p>Valid : the state in operation</p> <p>Default : no order</p> <p>Available software : RANDOM</p>
UP	<p>This item is for increasing of the excitation level for the specified value in Control Condition. (Note 1)</p> <p>Valid : in the state of waiting for operation start or executing the test operation</p> <p>Default : no order</p> <p>Available software : SINE, RANDOM</p>
DOWN	<p>This item is for decreasing of the excitation level for the specified value in Control Condition. (Note 1)</p> <p>Valid : in the state of waiting for operation start or executing the test operation</p> <p>Default : no order</p> <p>Available software : SINE, RANDOM</p>

Name	Order
TRIG	This item is for setting of external trigger. Valid : in the state of waiting for external trigger ON Default : no order Available software : CAPTURE
NEXT	This item is for proceeding to the next step (each process divided at the point of a waiting state for the operator's order is called 'step'). Valid : in the state of waiting for the order to proceed to the next step Default : no order Available software : SHOCK
RETRY	This item is for preparing of excitation restart/reacquisition. Valid : in the state of excitation finished. Default : no order
NXLOOP	This item is for renewing the drive data. Valid : in the state of excitation finished. Default : no order Available software : SHOCK
EXIT	This item is for exiting from test operation mode. Valid : in the state of test operation mode except for in operation Default : no order
XFRRNW	This item is for renewing the XFR data. Valid : in the state of excitation finished. Default : no order Available software : SHOCK
AUXIN1	This item is valid only when the application program defines signal specification. SINE : Sweep reverse (valid only in Sweep Test) RANDOM : Sweep reverse (valid in SOR, ROR)
AUXIN2	Auxiliary output 2 : the same as in the above SINE : Fixed sweep (Spot) / Cancel (Valid only in Sweep Test, Spot Test). RANDOM : Sweep reverse / Cancel (valid in SOR, ROR)
AUXIN3	Auxiliary output 3 : the same as in the above SINE : Shift to the next spot (valid only in Spot Test)
AUXIN4	Auxiliary output 4 : the same as in the above SINE : This item is for increasing of the excitation frequency for the specified value in Operation Setting. (valid only in Manual Test) (Note 2)
AUXIN5	Auxiliary output 4 : the same as in the above SINE : This item is for decreasing of the excitation frequency for the specified value in Operation Setting. (valid only in Manual Test) (Note 2)
AUXIN6	Auxiliary output 6 : the same as in the above SINE : Skipping to the beginning of the next sweep / Skipping to the first spot (Valid only in Sweep Test, Spot Test).
AUXIN7	Auxiliary output 7 : the same as in the above

Name	Order
AUXIN8	Auxiliary output 8 : the same as in the above
AUXIN9	Auxiliary output 9 : the same as in the above
AUXIN10	Auxiliary output 10 : the same as in the above
AUXIN11	Auxiliary output 11 : the same as in the above
AUXIN12	Auxiliary output 12 : the same as in the above
AUXIN13	Auxiliary output 13 : the same as in the above
AUXIN14	Auxiliary output 14 : the same as in the above
AUXIN15	Auxiliary output 15 : the same as in the above
AUXIN16	Auxiliary output 16 : the same as in the above

Name	Order
Emergency stop	This item is for operating of emergency stop. The mute function of D/A converter decreases the drive output in hardware.

Note 1) Order signal must be a pulse keeping up more than about 500ms.

Excitation level is increased/decreased for the level specified in the application program by a single pulse.

Pulses can be outputted continuously with having an interval of 500ms between each pulse.

Note 2) Order signal must be a pulse keeping up more than about 500ms.

Excitation frequency is increased/decreased for the level specified in the application program by a single pulse.

Pulses can be outputted continuously with having an interval of 500ms between each pulse.

Note 3) When the same input contact signal is set to multiple input terminals, the operation is as follows.

- AND condition (When all input contact signals are ON, the order is to be valid)  
RMTENB, SYSRDY
- OR condition (When one of input contact signals is ON, the order is to be valid)  
Contact input signal other than the listed above

## Output Part

Name	Order
HOLDOFF	The specified terminal is not used.
HOLDON	The system is in Test Operation mode.
WSTART	The system is in the state of waiting for excitation start, for XFR measurement start or for acquisition start.
WTRIG	The loop is to be 'closed' in the waiting state for the external trigger.
WNEXT	This system is in the state of waiting for proceeding to the next step (each process divided at the point of a waiting state for the operator's order is called 'step'). Available software : SHOCK
INMEAS	The system is in XFR measurement. (Initial measurement is not included.) Available software : SHOCK
INOPE	The system is in test operation or in data acquisition. (Including the state in pause. However, the state in XFR measurement is not included.)
SIGOUT	The system is outputting the drive signal. (Including the state in XFR measurement)
INPAUSE	The system is in pause.
EXC0DB	The system is operating the excitation at 0dB of excitation level.
TIMEUP	Test operation is completed when the specified test time is passed. (Finished normally) (This signal is ON for 1 second)
FINISHED	The system is in the state of excitation completion. (Including abort)
ABORTED	The excitation is stopped by abort function.
ALARM	The system is in the state of alarm detected. Available software : SINE, RANDOM
CHKERR	The excitation is stopped according to the result of Tolerance check as 'NG'.
LEVEL CHANGE	Excitation level is changed. (This signal is ON for 1 second) Available software : RANDOM
AUXOUT1	This item is valid only when the application program defines signal specification.
AUXOUT2	Auxiliary output 2 : the same as in the above
AUXOUT3	Auxiliary output 3 : the same as in the above
AUXOUT4	Auxiliary output 4 : the same as in the above
AUXOUT5	Auxiliary output 5 : the same as in the above
AUXOUT6	Auxiliary output 6 : the same as in the above SHOCK, BMAC : The contact output signal synchronized with contact input signal ' SYSRDY'. Used in driving simulator system.
AUXOUT7	Auxiliary output 7 : the same as in the above
AUXOUT8	Auxiliary output 8 : the same as in the above
AUXOUT9	Auxiliary output 9 : the same as in the above

Name	Order
AUXOUT10	Auxiliary output 10 : the same as in the above
AUXOUT11	Auxiliary output 11 : the same as in the above
AUXOUT12	Auxiliary output 12 : the same as in the above
AUXOUT13	Auxiliary output 13 : the same as in the above
AUXOUT14	Auxiliary output 14 : the same as in the above
AUXOUT15	Auxiliary output 15 : the same as in the above
AUXOUT16	Auxiliary output 16 : the same as in the above

## 4.9 IT Function

### 4.9.1 Web Monitor

The function of Web Monitor is for monitoring the test execution status of the K2 through the PC connected to a LAN.

Any special software are not necessary to be installed ; the display data of the K2\*) is directly saved in a file as HTML format, and the test status can be checked by using a popular browser, such as Microsoft® Internet Explorer, from any PCs on the LAN.

Web Monitor is only for monitoring the test status. Additional client option is necessary to operate the remote control that is used to execute other operations, such as Test Stop or Test Start, from a distant place.

LAN environment is required to use this function.

\*) To be exact, the display data of the PC on which the client program of the K2 is running is saved in a file as HTML format periodically in the disk of a specified PC. Note that any of the current display data is saved as HTML format when other applications than the K2 are executed on the PC simultaneously with the client program of the K2

< Procedure (to set Web Monitor) >

< Step 1 >

Select “Option” on the Menu Bar, and click the item of “Web Monitor setting”.

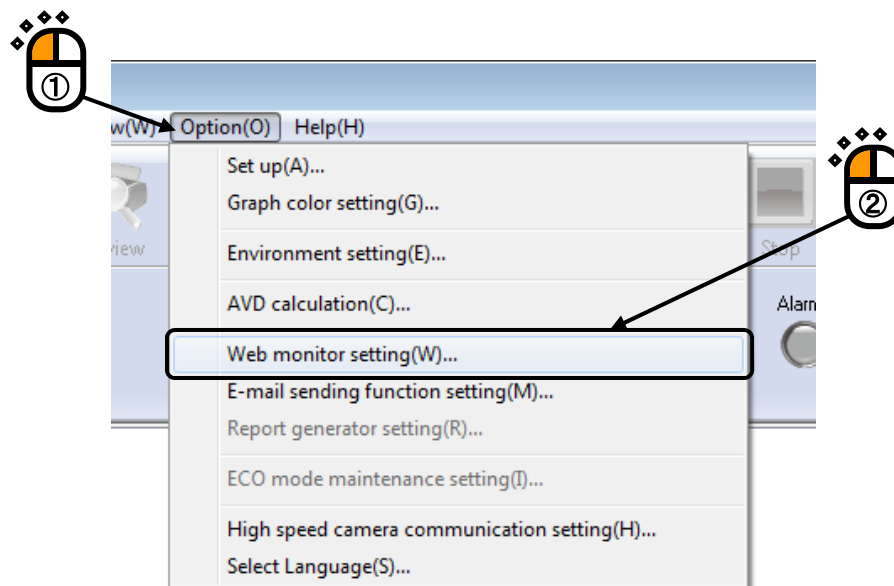

< Step 2 >

Check the check box of [Assert Web monitor] to be activated. And, set the necessary items.  
Please ask to the administrator of Net Work about the setting if it is necessary.

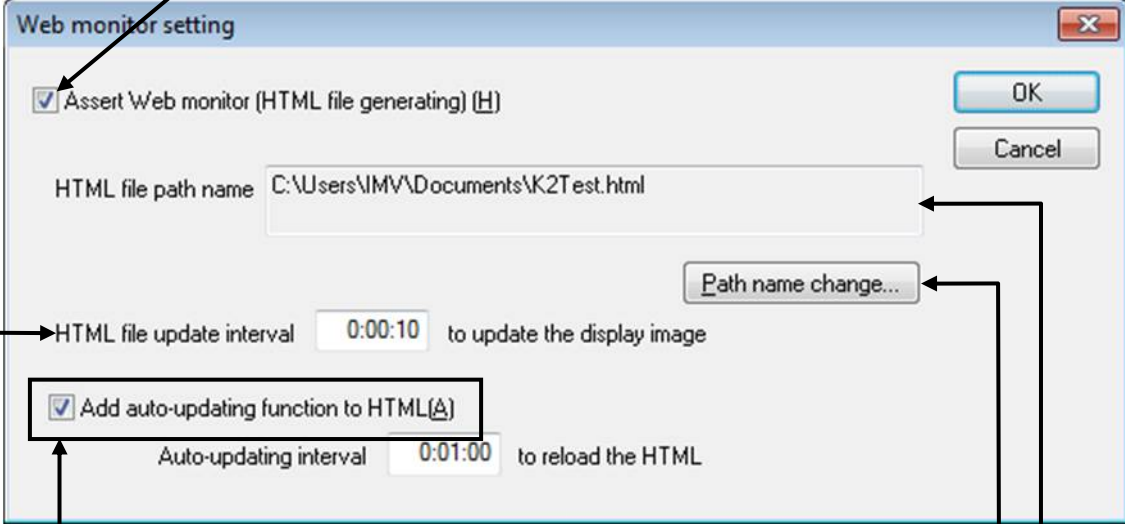

The screenshot shows the 'Web monitor setting' dialog box. It has a title bar with a close button. The main area contains several settings:

- A checked checkbox labeled 'Assert Web monitor (HTML file generating) (H)'. An arrow points from a mouse cursor icon above to this checkbox.
- A text field for 'HTML file path name' containing 'C:\Users\IMV\Documents\K2Test.html'. An arrow points from a text box below to this field.
- A 'Path name change...' button next to the text field.
- A time field for 'HTML file update interval' set to '0:00:10' with the text 'to update the display image'.
- A checked checkbox labeled 'Add auto-updating function to HTML(A)'. An arrow points from a text box below to this checkbox.
- A time field for 'Auto-updating interval' set to '0:01:00' with the text 'to reload the HTML'.
- 'OK' and 'Cancel' buttons in the top right corner.

Annotations and explanatory text boxes:

- A text box at the bottom left: 'This item is for specifying the interval of each HTML file generated by the K2.' An arrow points from this box to the 'HTML file update interval' field.
- A text box at the bottom middle: 'This item is for specifying the name of HTML file generated by the K2.' An arrow points from this box to the 'HTML file path name' field.
- A text box at the bottom right: 'The HTML file name specified in this item is displayed.' An arrow points from this box to the 'HTML file path name' field.
- A large text box in the center: 'When the display of a browser is needed to be renewed periodically and automatically on the PC for monitoring, check the check box of 'Add the auto-updating function to HTML' and specify the value of 'Auto- updating interval'. When 'Add the auto-updating function to HTML' is not checked to be activated, the monitoring condition that displayed in the PC browser is not renewed. The displayed contents cannot be changed as long as it is changed by manual.' An arrow points from this box to the 'Add auto-updating function to HTML' checkbox.

<Procedure (monitoring in test operation)>

HTML file generated by the K2 is opened by using a browser in the PC on the LAN.  
The example display as below is in the case of using Microsoft® Internet Explorer.

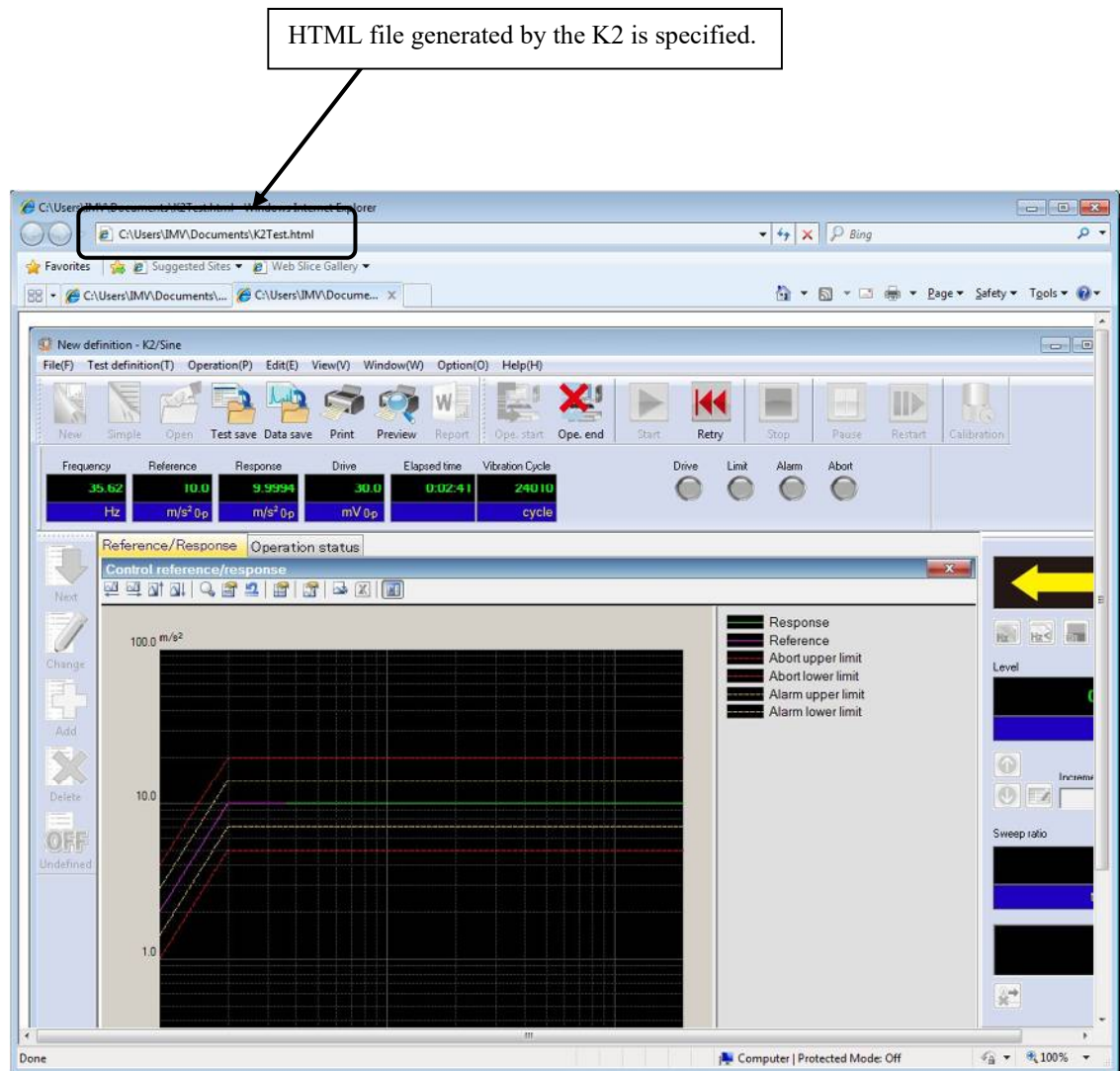



## 4.9.2 E-Mail Sending Function

E-Mail Sending Function is for informing stop/completion of the excitation. When the excitation is stopped or completed, the system sends the event of test stop to the specified mail address by E-Mail.

For example ; in the case that an operator started the excitation in the morning and left the laboratory. In the evening, the operator went back to check the state of the excitation. However, the excitation had stopped after 5 minutes from the excitation start because the pickup happened to be dislocated. Such an accident in operation can be acknowledged by E-Mail Sending Function. The operator can be saved from wasting of time and an efficient operation can be realized.

Also, E-Mails can be sent to the address of cellular phones.

LAN and the environment for sending E-Mails (Mail Server, Mail Address, Mailing Software) are necessary to use this function.

< Procedure (to set E-Mail Sending Function) >

< Step 1 >

Select “Option” from the Menu Bar, and click the item of “E-mail Sending Function setting”.

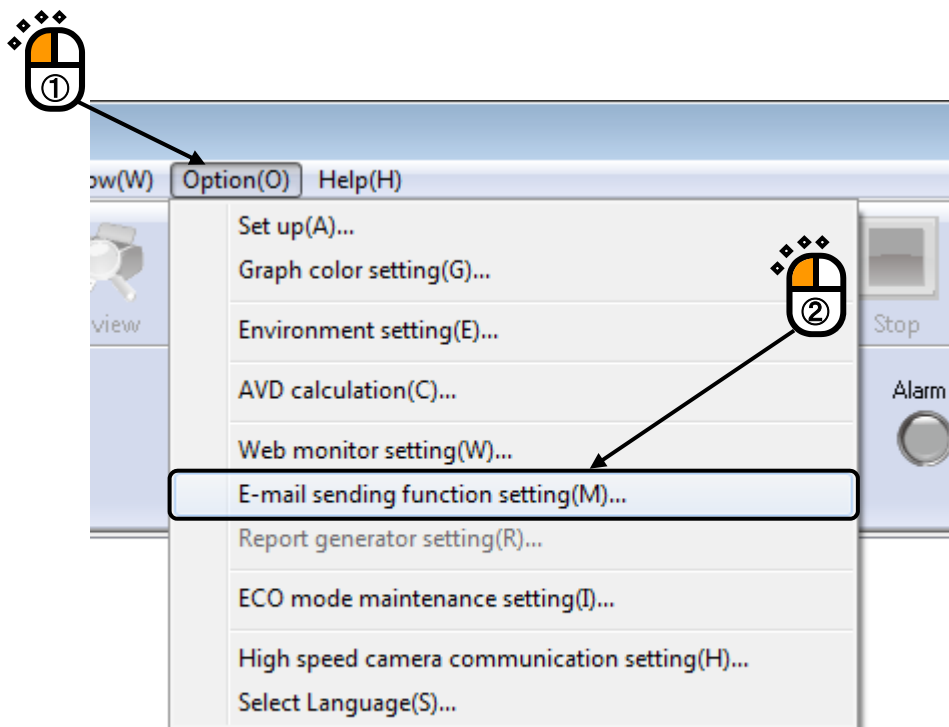

< Step2 >

Check the check box of 'Assert E- mail sending function(sending a e-mail)'.  
And set the necessary items.

In initial setting, the outgoing mail server setting window automatically opens.

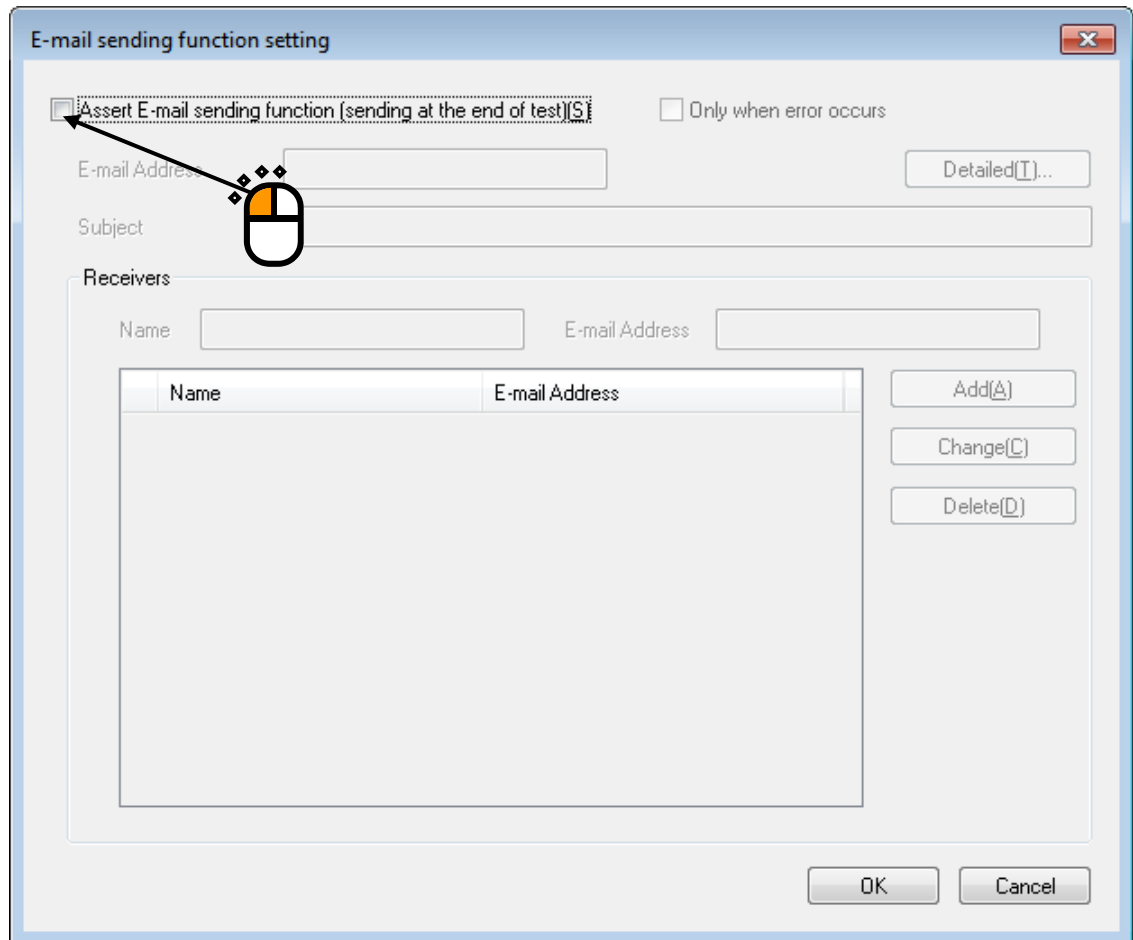

< Step3 >

Set the outgoing mail server.

Please ask to the administrator of Net Work about the setting of sending mails if it is necessary.

**E-mail sending function detail setting**

Outgoing mail server (SMTP)

Port number  Use Defaults(D)

Type of encrypted connection

Disable SSL certificate validation

Outgoing mail server (SMTP) requires authentication(M)

Log on using following account and password

Type of mail server authentication

Log on to incoming mail server before sending mail

Incoming mail server (POP3)

Port number  Use Defaults(E)

Authentication using APOP(A)

Use the incoming mail server settings

Logon Information

Account name

Password

OK Cancel

< Step4 >

Set the mail sending information.

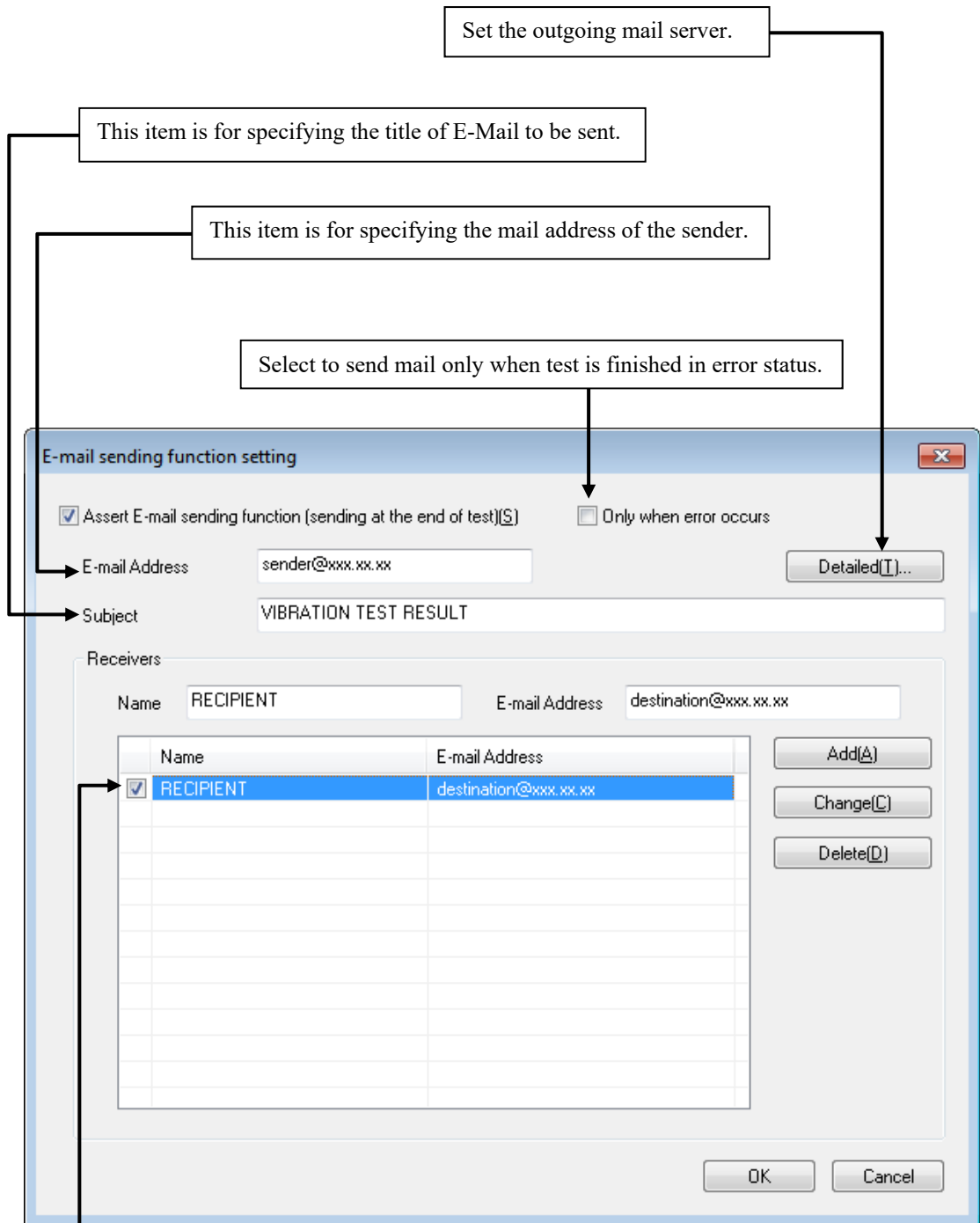

Specify an E-Mail address to send the E-Mail.  
E-Mail is sent to the addresses registered in this list from the K2.  
However, note that E-Mail may not be sent to any addresses when there is a mistake among these registered addresses.

### 4.9.3 Report Generator (Auto-generating function of the testing result report)

The function of Report Generator is for generating a report of testing result automatically when the test operation is completed.

Usually, it has a lot of trouble in generating the report of testing result for attaching the graphs and adding the description of test information. However, to use the function of Report Generator, the operator may be saved dramatically from the trouble in generating reports and the efficient operation can be realized.

In the K2, the information that is the definition contents, the testing results and the graphs can be used by linking with Bookmarks of Microsoft® Word. The numeral values, the letters and the graphs specified as Bookmarks can be attached to the report automatically when these Bookmarks are described in Template files of Microsoft® Word.

The forms of testing result reports used frequently are recommended to be saved in a Template file of. So that the same forms of testing result reports can easily be made by one-click. Forms of testing result reports can be customized for the operator depending on his purpose by using Microsoft® Word.

Microsoft® Word is required to use this function.

Note) This function supports only for Microsoft® Word 2010, Microsoft® Word 2013 , Microsoft® Word 2016 and Microsoft® Word 2019.

< Procedure (to set Report Generator) >

< Step 1 >

Select “Option” from the Menu Bar. And, click “Report Generator setting”.

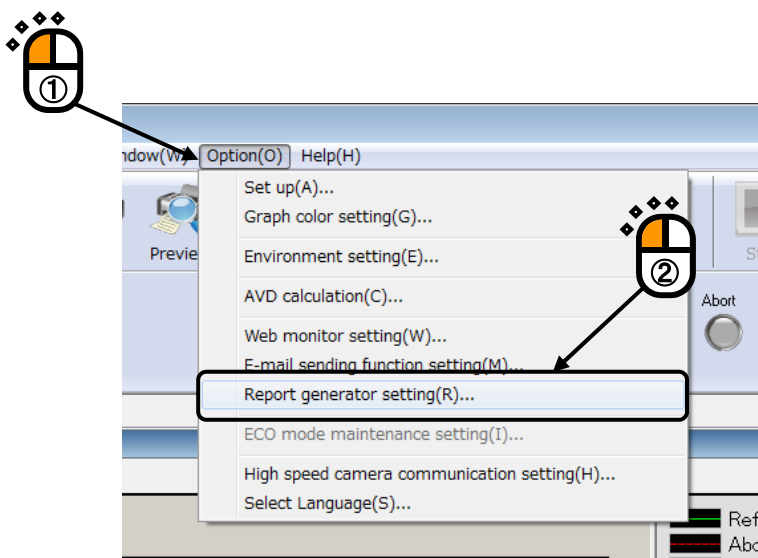

< Step 2 >

A : Press the [Corresponding] button to change the Template file of Microsoft® Word to be used or to make correspondence of the Output Items with Bookmarks newly.

→ Go to < Step 3 >.

B : Select the registration name in ‘Select by registered name’ to use the Output Items corresponded with Bookmarks that have already been registered.

→ Go to < Step 7 >

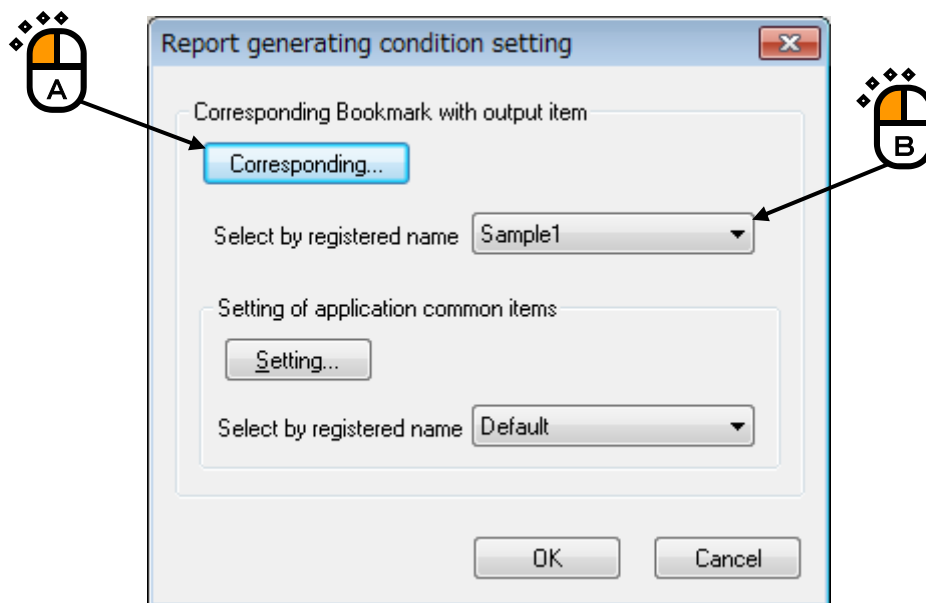

< Step 3 >

Press [Select] to specify a Template file of Microsoft® Word to be used (①).  
(The Template file to be used is needed to be made beforehand.)

When the Template file is selected, Bookmarks set in the Template file are listed in ‘Correspondence Table’.

Next, the Output Item is to be made correspondence with Bookmarks.

Select a Bookmark name to be set among the list of ‘Correspondence Table’ (②). And specify an Output Item from the list of ‘Output Item name’ (③). Press the [Change] button in Correspondence Definition(④).

Available Output Items vary in each applications as SINE/RANDOM.

<Graph Data>

The graphs displayed at generating reports are treated as the objective for ‘Graph’ among Output Items. When other graph data (‘Operation’, ‘Response’, etc.) is specified as output item, the graph data is outputted to the bookmark automatically even if the data is not displayed as a graph.

The setting of color and lines of the graph are selected from the items specified by “Option” → “Graph color setting”.

When the Template file is selected, the Bookmarks set to the Template are listed.

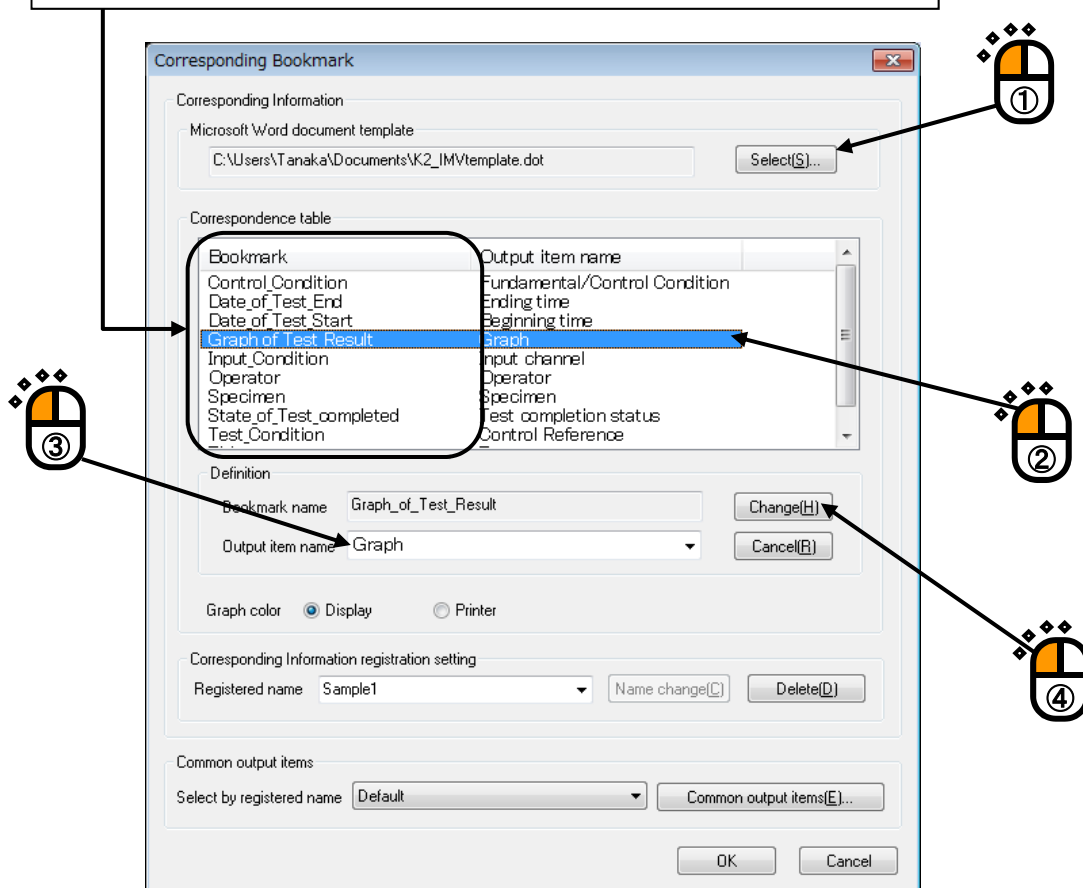

< Step 4 >

The definition of 'Common Output Items' is done if it is necessary.

A : Press the [Common output items] button to change the setting of Common Output Items.

→ Go to < Step 5 >

B : Specify a registration name in 'Select by the registration name' to use the Common Output Items that have already registered.

→ Go to < Step 6 >

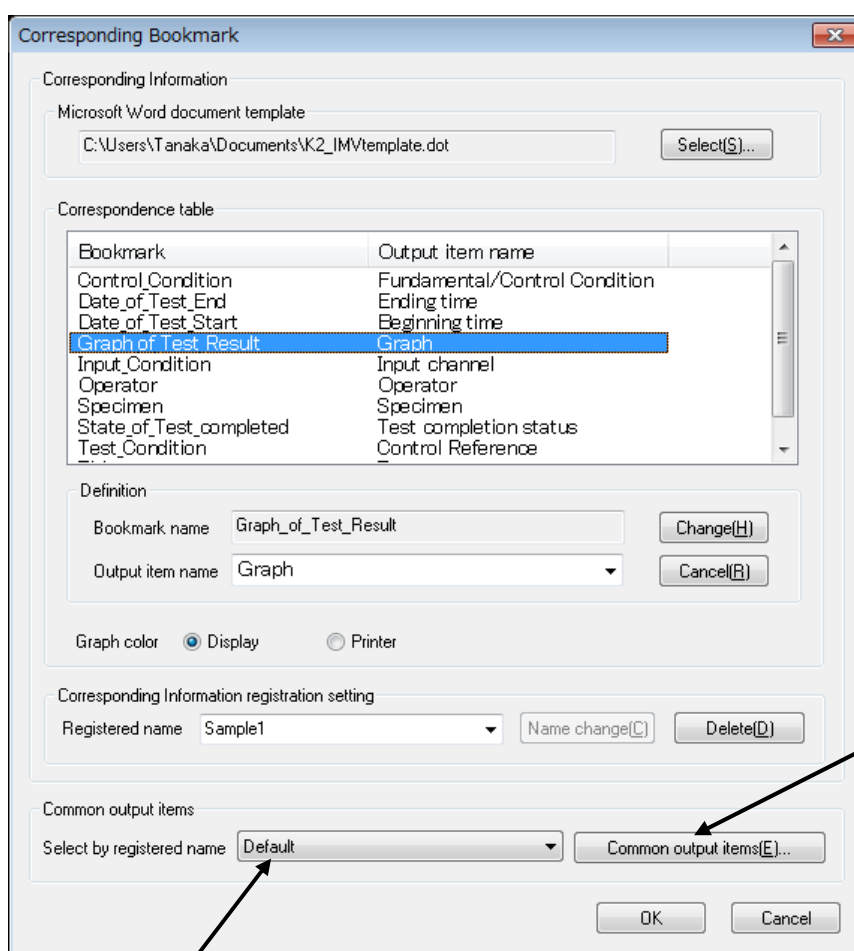



< Step 5 >

The information specified in Common Output Items is other than the test definitions and the testing results in Output Items displayed in Correspondence Definition.

The contents registered in this item is attached to the Bookmarks corresponded with.

The characters and the numeral values are set to the Output Item to be needed (①).

Specify a registration name of 'Common Item set' to register the set Common Output Item (②).  
And, press the [Name change] button (③).

When the set Common Output Item is registered in this item, it can be selected in 'Select by registered name' at < Step 4 > (or < Step 7 >).

Press [OK] after completing of the necessary settings (④).

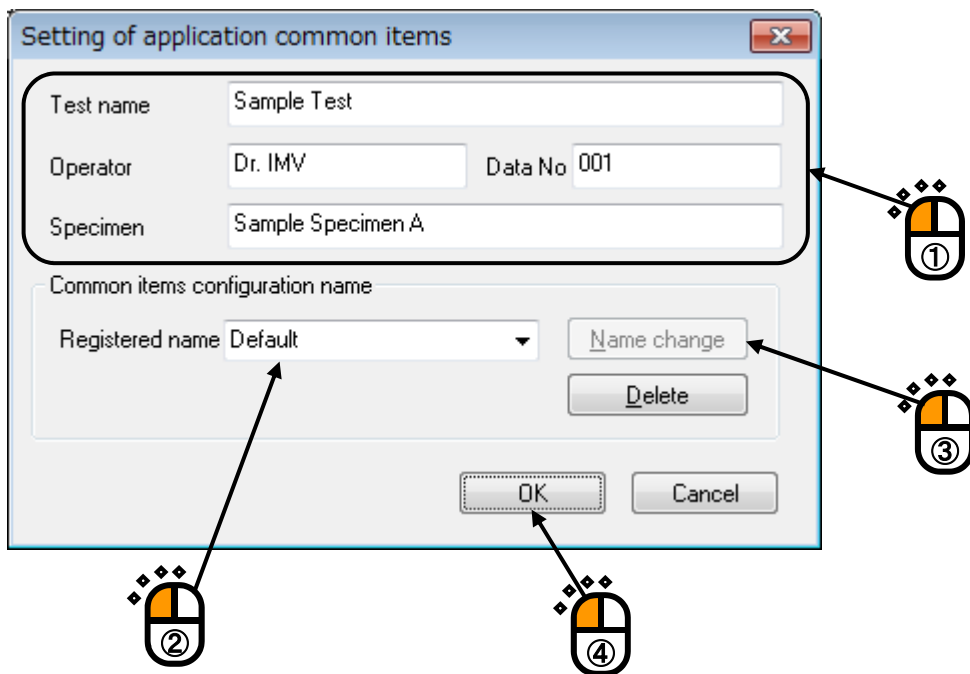

< Step 6 >

Specify a registration name of 'Correspondence Definition Registration' to register the set Correspondence(①). And, press the [Name change] button(②).

When the set Correspondence Item is registered in this item, it can be selected in 'Select by registered name' at < Step 2 >.

Press [OK] after completing of the necessary settings (③).

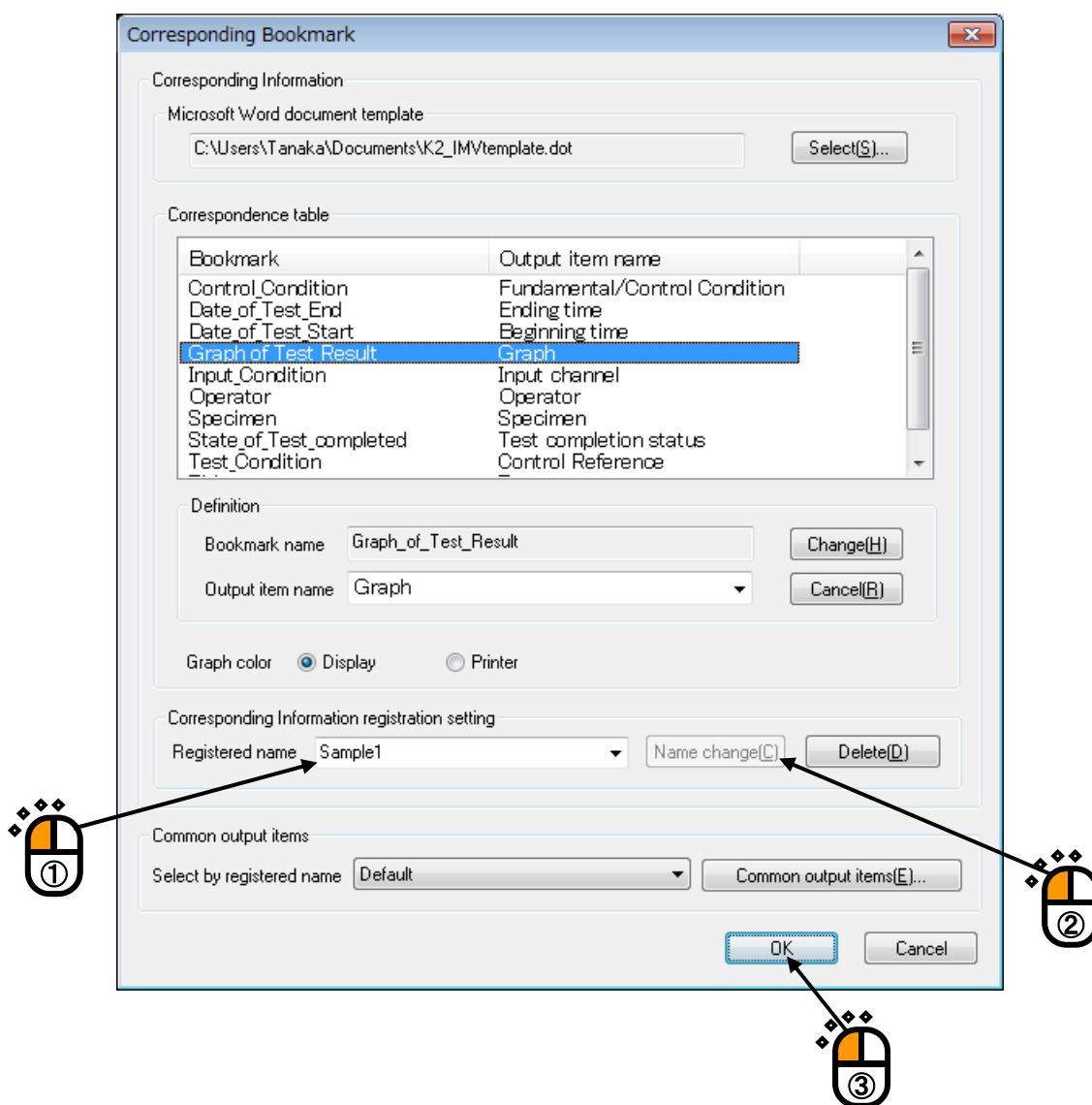

< Step 7 >

The definition of 'Common Output Items' is done if it is necessary.

A : Press the [Setting] button to change the setting of Common Output Items.

→ Go to < Step 8 >

B : Specify a registration name in 'Select by the registration name' to use the Common Output Items that have already registered.

→ Go to < Step 9 >

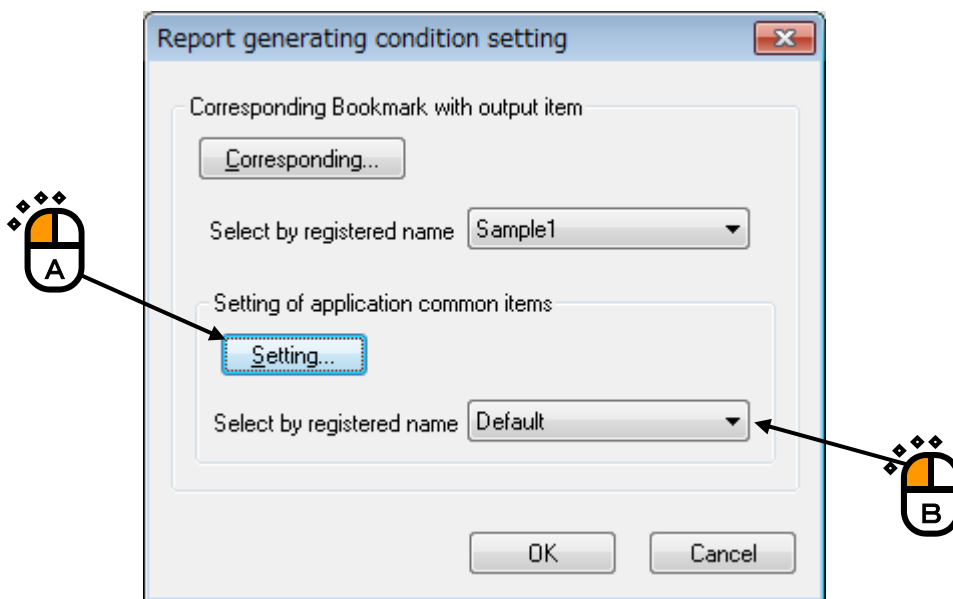

< Step 8 >

The information specified in Common Output Items is other than the test definitions and the testing results in Output Items displayed in 'Correspondence Table'.

The contents registered in this item is attached to the Bookmarks corresponded with.

The characters and the numeral values are set to the Output Item to be needed (①).

Specify a registration name of 'Common Item Set' to register the set Common Output Item (②).  
And, press the [Name change] button (③)

When the set Common Output Item is registered in this item, it can be selected in 'Select by registered name' at < Step 7 > (or < Step 4 >).

Press [OK] after completing of the necessary settings (④).

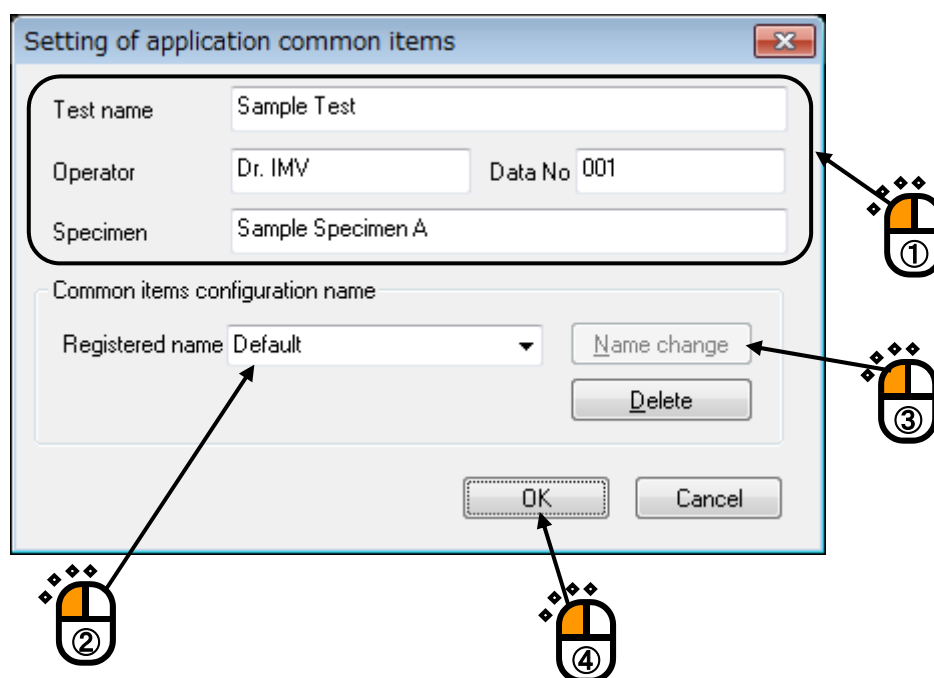

< Step 9 >

Press [OK] after completing of the necessary settings.

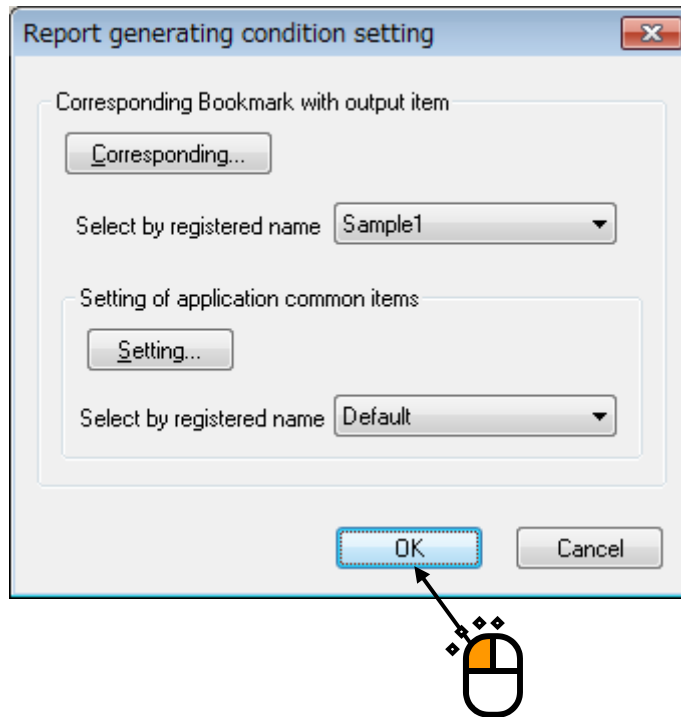

< Procedure(to Report) >

Press the [Report generation] button in the state of Test completed.

When the [Report generation] button is pressed, a WORD file according to the setting of Report Generator is generated automatically.

The graphs displayed at pressing the [Report generation] button are treated as the objective for 'Graph' of Output Items.

The description in the next page is an example of the report of testing result generated by Report Generator.

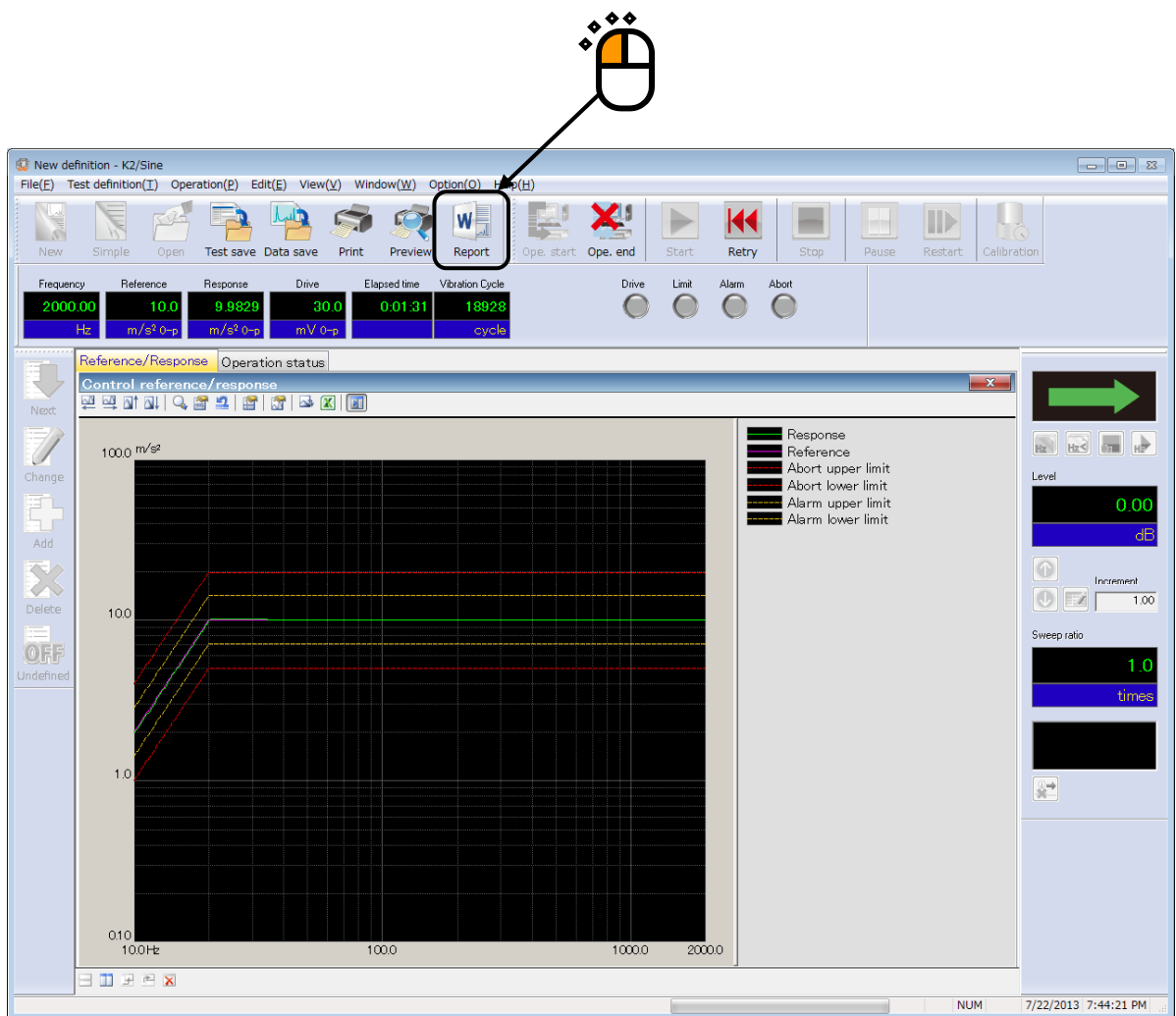



## Report of Vibration Test Operation

Page 1  
Date 04/04/02

Title	Sample Test		
Specimen	Sample Specimen A		
Date of Test Start	2004/04/02	Date of Test End	2004/04/02
	10:35:15		10:36:32
State of Test completed	Test time is completed.		
Operator	Dr. IMV		
Comment			

### Test Condition

Sweep mode	Log		
Sweep direction	Forward-double		
Sweep rate	1.0 min/single-sweep	(7.644 octave/min)	
Sweep pause time	0:00:00		
Test time	By single sweep counts 1 single-sweep		
Internal record	Normal		
Manual	Not operate		
Sweep profile			
Frequency range	10.0 <==> 2000.0 Hz		
Acc.	10.0 m/s <sup>2</sup> 0-p(	22.508 <==> 2000.0 Hz)	
Disp.	1.0 mm p-p(	10.0 <==> 22.508 Hz)	
Tolerance			
Abort	Alarm		
Upper limit	6.0 dB	3.0 dB	
Lower limit	[-6.0 dB] [-3.0 dB]		
Sweep rate segment	None		

### Graph of Test Result

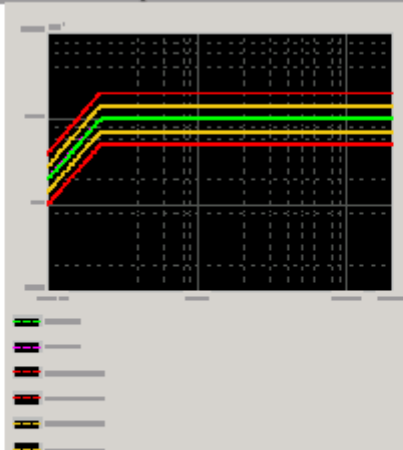

IMV CORPORATION

#### 4.9.4 Quick Report

The function of Quick Report is for writing the testing result through a web browser or Microsoft® Word after a test is finished, in a similar manner to the Report Generator. It features easier setting than the Report Generator and non-necessity of Microsoft® Word. On the other hand, it does not allow fine position adjustment. Use the functions appropriately for your purpose.

If you choose Microsoft® Word as the destination of the result with this function, the corresponding version is the same as that of the Report Generator.

< Procedures (Selection of output items) >

< Step 1 >

After a test is finished, select “File” in the menu bar and click “Quick report generation”.

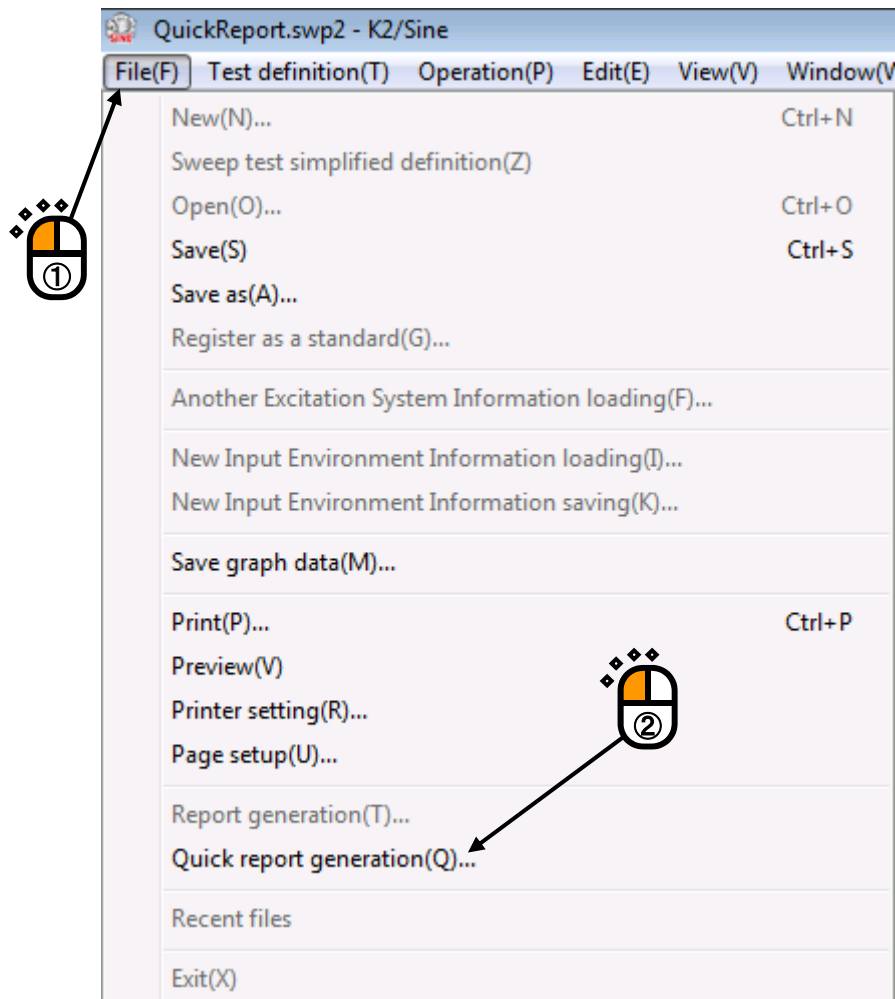



< Step 2 >

The dialog to select the item to be output to a quick report opens.

To add a logo, input or select the path to the target image file.

Saves the status selected at ending.

Either PNG (raster type) or EMF (vector type) graphic image type can be selected. In the EMF, images do not get rough even figures are enlarged. However, figures cannot displayed through any browser other than Internet Explorer.

This dialog is of SINE. Selection items vary slightly depending on the application.  
Click [Output] button.

< Step 3 >

Quick report is generated through the selected display software.

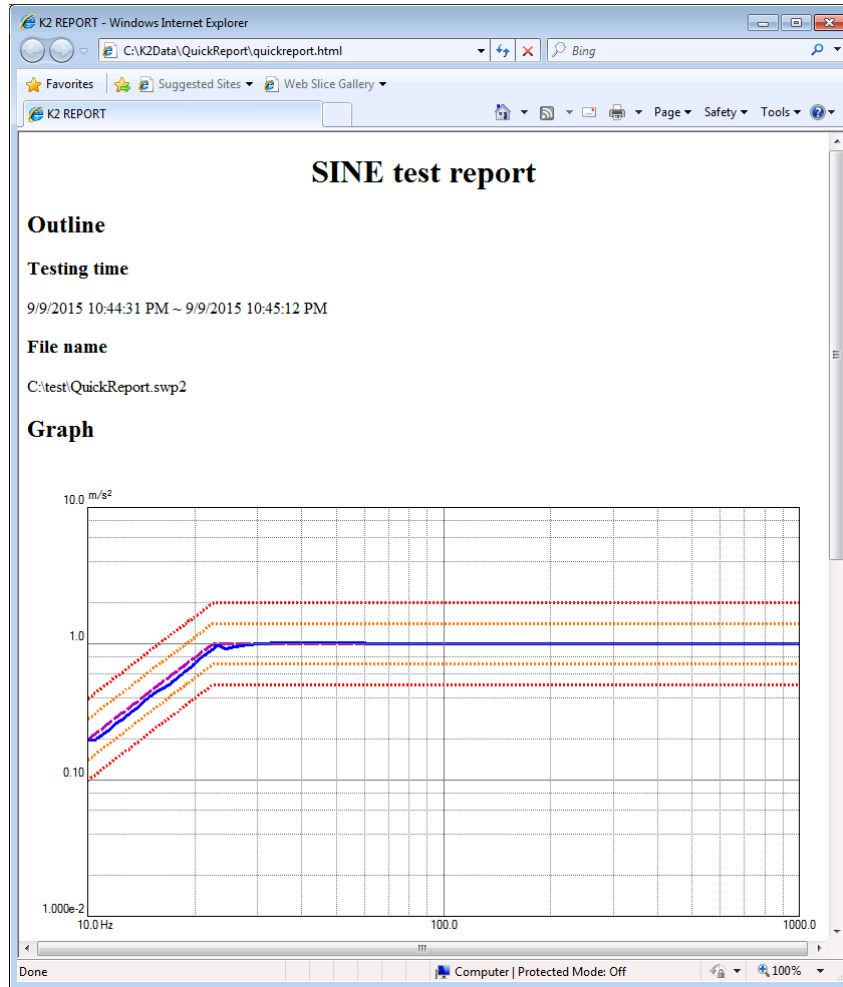

< Procedures (Generation of quick report with button operation) >

When a test is finished, press [Quick] button.

When the [Quick] button is pressed, a quick report is generated through the display software.

Items to be output are the last settings that the quick report is generated by “Quick report generation” in the menu bar.

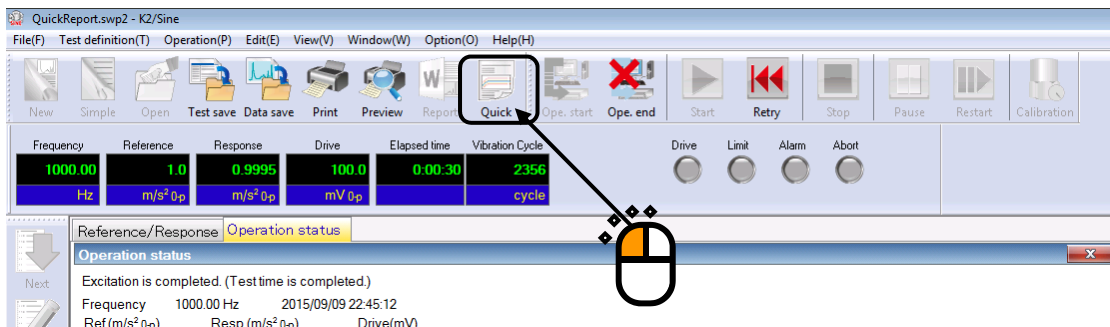

## 4.10 Waiting for Stabilization of IEPE Sensor

When using the IEPE sensor, stabilization of response of the IEPE sensor is needed after the initialization of K2 hardware.

This function allows automatic judgment whether response of the IEPE sensor is stabilized or not.

### < Outline >

When the operation start button is pressed while the IEPE sensor is used, the screen of “Waiting for stabilization of IEPE” appears. It remains displayed until response of all the IEPE sensors is stabilized. When response of all the IEPE sensors is stabilized, the screen of waiting for stabilization of IEPE automatically disappears, and the operation mode is switched to the waiting for excitation start status.

When the stop button is pressed while the screen of “Waiting for stabilization of IEPE” is displayed, the operation mode is switched to the waiting for excitation start status. In this case, note that some noises are included in response from the sensor, and thus, correct measurement may not be able to be done.

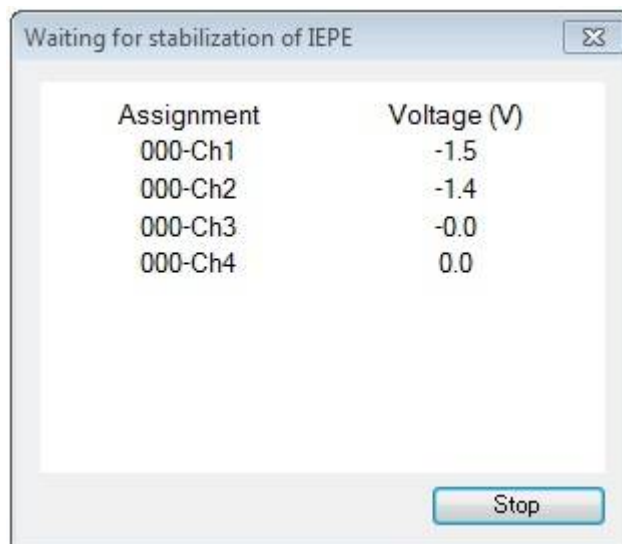

### < Judgment of stabilization >

If response of the IEPE sensor remains in the range of  $\pm 100$  mV for 5 seconds, response is judged to be stabilized.

### < Process to execute application program from software >

When application programs such as SINE are executed from external software including Scheduler, the screen of “Waiting for stabilization of IEPE” is not displayed. In this case, unless response of the IEPE sensor is stabilized within 60 seconds, the initialization is judged to be failure and the test is aborted.

## 4.11 Customizing Toolbar Buttons

This function allows change in the order of toolbar buttons shown on the display of K2 application and choice between display and non-display of toolbar buttons and addition of separators.

< Procedures >

< Step1 >

Select [Option] in the menu bar, and click [Customize toolbar button].

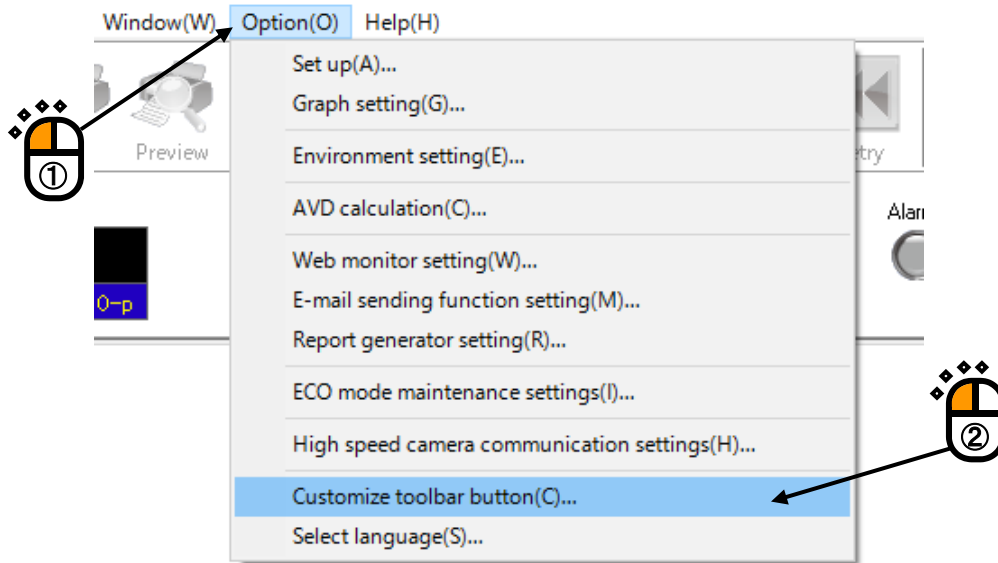

< Step 2 >

Remove check in the checkbox of a toolbar button not to be displayed (①).

\* One or more buttons need to be displayed in each toolbar.

If order of any button needs to be changed, select the button first (②), and move the cursor with upward or downward arrow button (③).

If any separator needs to be inserted, select the button just above it, and press [Separator] button (④).

To return to the initial status, press [Reset] button (⑤).

After all procedures are complete, press [OK] button (⑥).

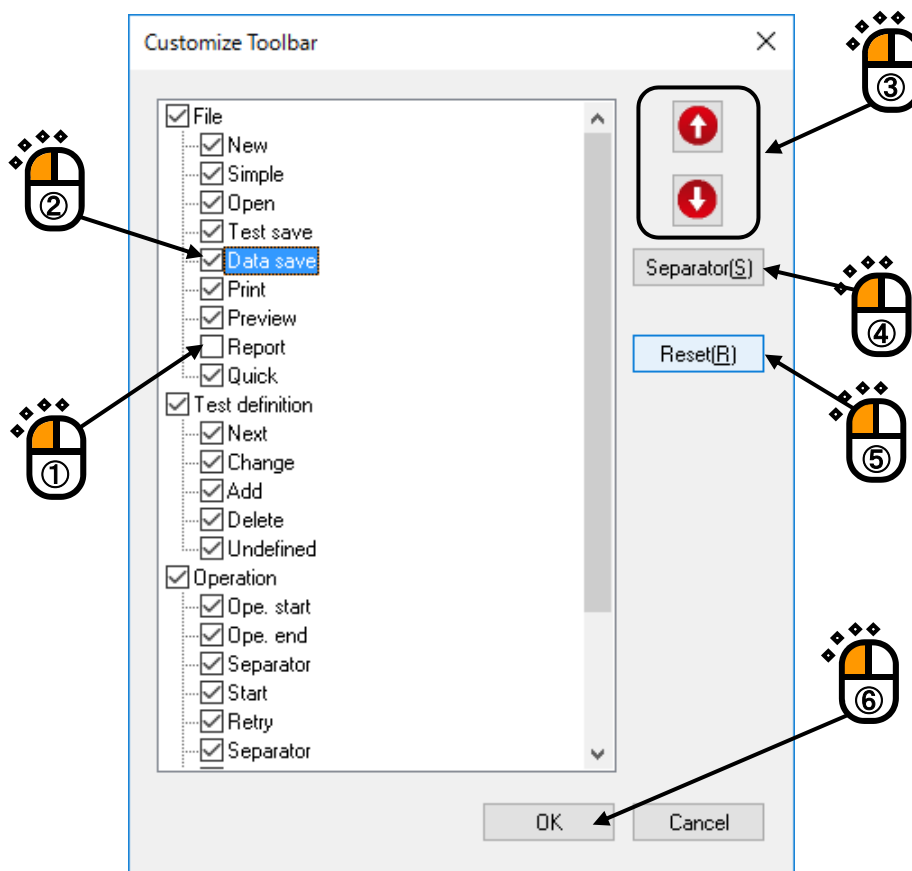

Message shown below appears. After the application is rebooted, display of tool bar is changed.

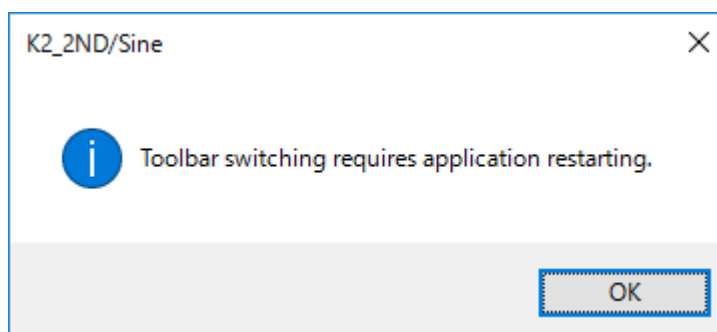

## Chapter 5 Energy-saving operation: ECO-option (ISM)

### 5.1 Outline

With the ECO-option attached, K2 realizes the energy-saving operation of the shaker system, just keeping the control accuracy and the usability of the ordinary K2 system. By the attachment of this option, the power consumption of the shaker system is minimized for the given excitation condition. The environmentally-friendly vibration testing is realized by the “ECO SHAKER” system.

ECO-option does not work alone within the K2 controller, but it works in collaboration with the <ISM-EM> Energy saving system to achieve the ECO SHAKER operation.

All the K2 application software in the ECO SHAKER system must be installed with the ECO-option; mixture of the ECO-option attached applications and not attached ones is not allowed.

### 5.2 Constraints in operation

The test definition information must be fixed before the Energy saving operation (E-save operation) of the ECO SHAKER system is begun, and some constraints in the operation mode become necessary for this reason. The constraints in SINE and RANDOM are explained in the below

#### 5.2.1 Constraints in SINE

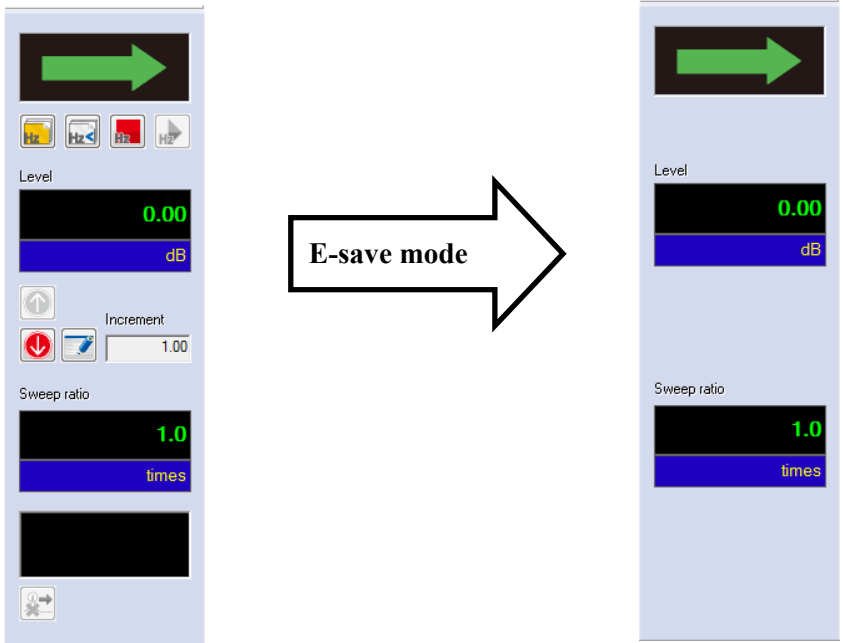
SWEEP (*1)	<p>Below buttons in the Manual operation tool bar are grayed out (invalidated): “Excitation level up”, “Excitation level down”, “Excitation level change”, “Shift to the beginning point of the next sweep”, “Sweep reverse”, “Sweep fixing”, “Sweep fixing cancel”</p> 
---------------	--

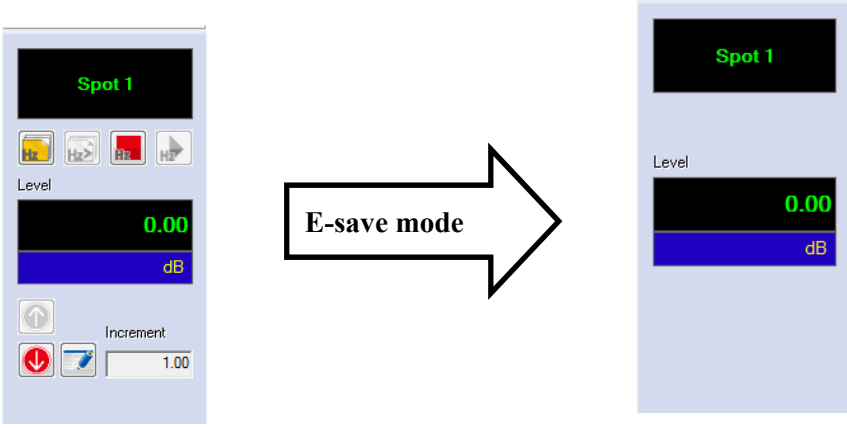
<p>SPOT (*1)</p>	<p>Below buttons in the Manual operation tool bar are grayed out (invalidated):  “Excitation level up”, “Excitation level down”, “Excitation level change”,  “Shift to the beginning of the spot”, “Shift to the next spot”,  “Spot fixing”, “Spot fixing cancel”</p> 
----------------------	--

(\*1) If the initial excitation level is specified to under 0dB, there is no constraints in operation.

But a part of E-save functionality or whole functionality becomes invalid.

- Air-cooled systems : Blower control only
- Water-cooled systems : E-save functionality is invalid

### 5.2.2 Constraints in RANDOM

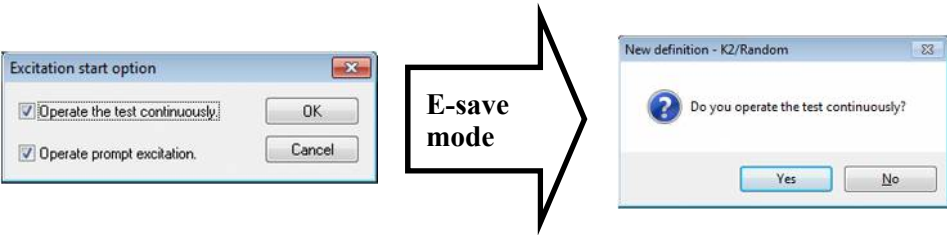
<p>Common</p>	<p>Prompt excitation in Retry excitation is invalidated.  The Excitation start option dialog which appears at the moment of Retry after stopping the excitation once in the ordinary mode is changed to a message box to select Yes/No of continuous excitation only.</p> 
---------------	--

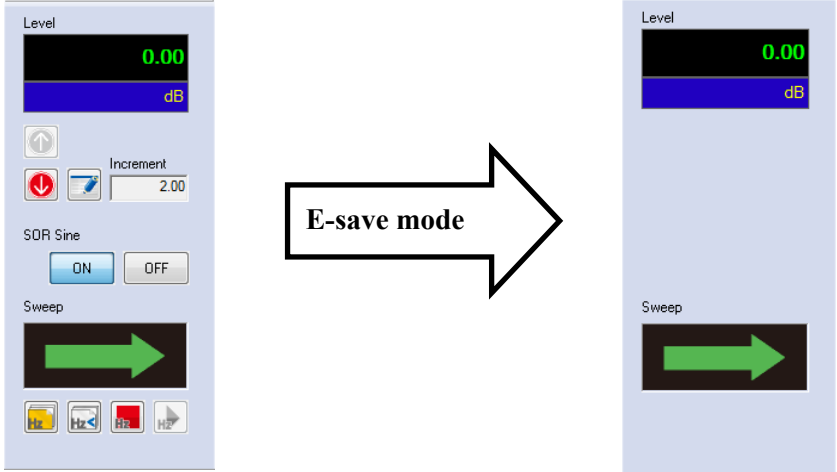
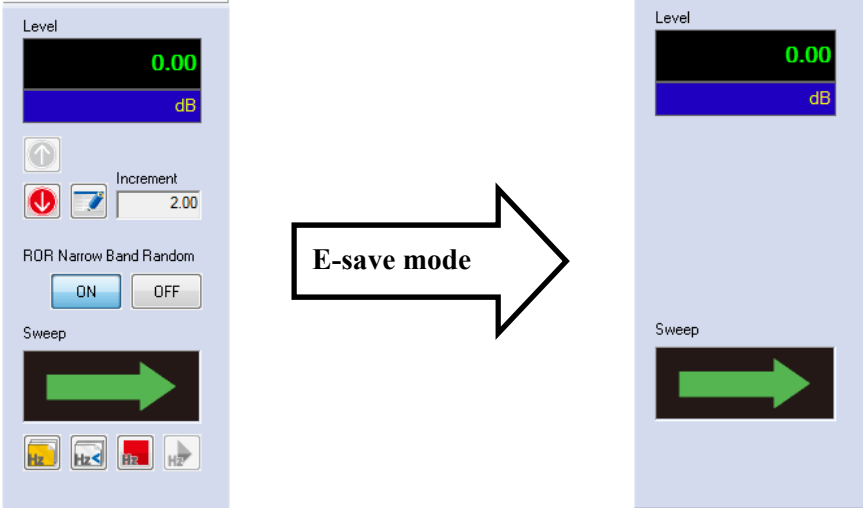
<p>SOR (*1)</p>	<p>Below buttons in the Manual operation tool bar are grayed out (invalidated):  “Excitation level up”, “Excitation level down”, “Excitation level change”,  SOR Sine “ON”, “OFF”,  “Shift to the beginning of the next sweep”, “Sweep reverse”,  “Sweep hold”, “Sweep hold cancel”</p> 
<p>ROR (*1)</p>	<p>Below buttons in the Manual operation tool bar are grayed out (invalidated):  “Excitation level up”, “Excitation level down”, “Excitation level change”,  ROR Narrow band Random “ON”, “OFF”,  “Shift to the beginning of the next sweep”, “Sweep reverse”,  “Sweep hold”, “Sweep hold cancel”</p> 

- (\*1) If the initial excitation level is specified to under 0dB, there is no constraints in operation.  
But a part of E-save functionality or whole functionality becomes invalid.
- Air-cooled systems : Blower control only
  - Water-cooled systems : E-save functionality is invalid

**5.3 (This section is left blank intentionally.)**



## 5.4 Settings for ECO-option

To make the ECO-option enabled, the ECO-option settings on K2 are necessary to be correctly set. The ECO-option settings here affects to all of the K2 application installed on the system.

Notice) If the setting items described here is changed incorrectly, the ECO SHAKER system would not work correctly. Please do not change the settings from those set at the shipping from the factory.

< Step 1 >

“Option” is selected from the Menu bar, and “ECO mode maintenance setting” is clicked.

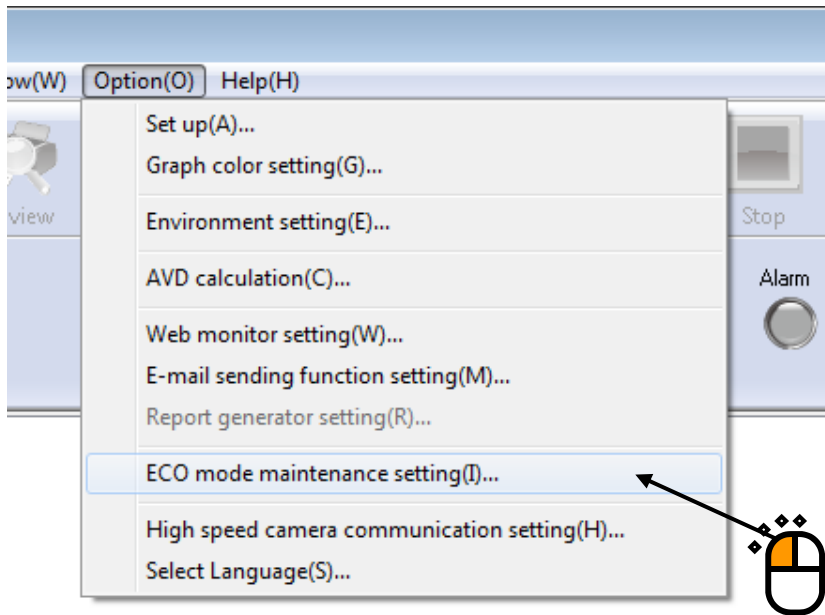

< Step 2 >

A message box for caution appears. [OK] is pressed.

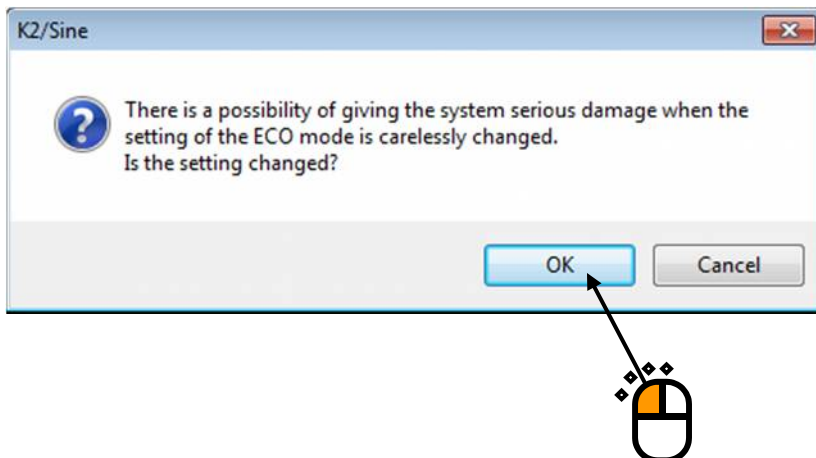

< Step 3 >

Correct setting is done here.

Required settings are completed before shipment. If any of settings needs modification, modify it after confirming our approval.

The screenshot shows the 'ECO mode maintenance settings' dialog box with the following settings and callouts:

- Use ISM:** Radio buttons for 'Yes' (selected) and 'No'. Callout: "Set the use or nonuse of the energy saving (ECO) system. If the energy saving (ECO) system installed in the excitation system is not used, however, it is required not only to select 'No' but also to modify the hardware."
- Communication settings:**
  - URI:** Text field containing 'localhost'. Callout: "Select the name (or address) of the computer installed with the program of the party communicating with the K2. Normally the program of the party to communicate with is installed in the same computer as that for the K2."
  - Port No.:** Spin box set to '10002'. Callout: "Select a communication port."
  - Timeout:** Spin box set to '3000' msec. Callout: "Set the period of time in which communication interruption is evaluated as an error."
  - Initialization:** Button. Callout: "Returns the settings to the default ones."
- Module ID:** Text fields for 'K2' (containing 'k2:1') and 'ISM' (containing 'em:1'). Callout: "Select the K2 and ISM IDs for communication."
- Communication log:**
  - Save log(L)
  - Log folder: Text field containing 'C:\MMV\K2\_Plus'. Callout: "Set K2 and ISM communication log saving."
  - Data(D)  Dispatch log  Contents(C)
- Control the field current even at low frequency. (The test may be stopped.)

Callout for the last checkbox: "At the low frequency test, it may be aborted since the changing rapidness of the field coil current is too fast than the control speed. So normally the field coil current is not controlled at the low frequency test, but it be forced to control when this item is checked. Use this function after confirming the test is possible."

### 5.4.1 Initial setting (factory setting)

Factory setting is as shown below.

To restore it, click [Initialization].

The image shows a software dialog box titled "ECO mode maintenance settings" with a close button (X) in the top right corner. The dialog is organized into several sections:

- Use ISM:** A group box containing two radio buttons: "Yes" (selected) and "No".
- Buttons:** "OK" and "Cancel" buttons are located to the right of the "Use ISM" section.
- Communication settings:** A group box containing:
  - URI:** A text input field with "localhost" entered.
  - Port No.:** A numeric spinner box set to "10002". To its right is an "Initialization" button.
  - Timeout:** A numeric spinner box set to "3000" with "msec" to its right.
  - Module ID:** A sub-group box containing two text input fields:
    - K2:** Input field with "k2:1" entered.
    - ISM:** Input field with "em:1" entered.
- Communication log:** A group box containing:
  - Save log(L):** A checked checkbox.
  - Log folder:** A text input field with "C:\IMV\K2\_Plus" entered. To its right is a "Refer(R)..." button.
  - Data(D):** A checked checkbox.
  - Dispatch log:** A checked checkbox.
  - Contents(C):** A checked checkbox.
- Control the field current even at low frequency:** An unchecked checkbox with the text "(The test may be stopped.)" below it.

# Chapter 6 Data Viewer

## 6.1 Outline

DATA VIEWER is attached as the standard software to display graph data file (\*.vdf) saved using a K2 application software such as SINE.

Graphs can be operated with DATA VIEWER in the same way as data on the application software. Available functions with DATA VIEWER are also same as those on the application software such as adding pages, converting to a CSV file etc. Please see “Chapter 4” for the details of the operation and those functions.

### 1) Available data with DATA VIEWER

- [1] Available graphs with the application software
- [2] Available operation status with the application software
- [3] Available test definition with the application software<sup>\*1</sup>
- [4] Available history log with the application software<sup>\*2</sup>

### 2) Available functions with DATA VIEWER

- [1] Available functions in graph operation with the application software
- [2] Print function
- [3] Report generation function using Report Generator
- [4] Function to overlay graphs of different files

Available functions when overlaying have some limitations. Please see the next paragraph for the details.

- [5] Display of different file 3D graph

Available functions when overlaying have some limitations. Please see the paragraph 4) for the details.

- [6] Report generation function using Quick Report<sup>\*3</sup>

### 3) Specification of the function to overlay graphs of different files

- [1] Available data files of the application software

SINE, RANDOM, SHOCK, CAPTURE

- [2] Available graph types

Waveform, SINE level tracing, PSD, Transmissibility (provided that the same unit is applied)

- [3] Number of graphs which can be overlaid

64graphs

- [4] Unavailable functions

Report Generator

4) Specification of display of different file 3D graph

[1] Available 3D graph display type

Waterfall graph, Color map

[2] Data file of available application software

SINE(SPOT test is unavailable), RANDOM, SHOCK, CAPTURE

[3] Available graph type

Response, Monitor, Monitor Distortion (SINE only), Drive (SHOCK only), Control error (SHOCK only)

(Unit should be same)

[4] Available depth axis data type

File name, Time <sup>\*4</sup>, Elapsed time (SINE, RANDOM only) <sup>\*4</sup>, Sweep count (SINE only) <sup>\*4</sup>, Loop count (SHOCK only) <sup>\*4</sup>

[5] Number of graphs displayable simultaneously

255

[6] Unavailable function

Report generator

\*1 This data is available from data saved by Ver7.0.5.0 or later.

\*2 This data is available from data saved by Ver12.2.0.0 or later.

\*3 The selection of operation status items is available from data saved by Ver12.2.0.0 or later.

All information of operation status is available in all version.

\*4 This data type is available from data saved by Ver11.2.0.0 or later.

## 6.2 Operation example

### 6.2.1 Description of Icons

The commands that frequently used in the menu bar are displayed as icons on the tool bar below the menu bar. When an icon is clicked, a command corresponding with the icon is executed immediately or a dialog box corresponding with this command is opened.



This command is for opening a new graph data file and adding a new graph window.

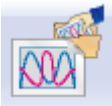

This command is for displaying new overlaid graphs and adding a new graph window.



This command is for displaying new 3D graph and adding a new graph window.



Print



Print preview



Report generation on Microsoft Word (Report Generator)



Quick report generation on web browser or Microsoft Word(Quick Report)



This command is for adding pages to the graph window which is currently selected.



This command is for adding graphs to the graph window page which is currently selected.



This command is for adding operation status to the graph window page which is currently selected.



This command adds test definition to the graph window page being selected.



This command adds history log to the graph window page being selected.

## 6.2.2 Display of Standard Graph

<Procedure>

<Step 1>

Press the [Open] button.

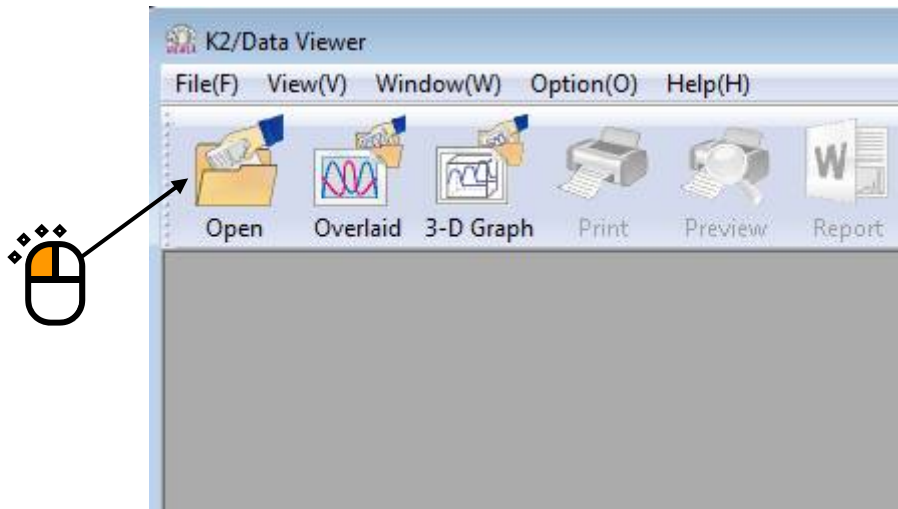

<Step 2>

Select the graph data file.

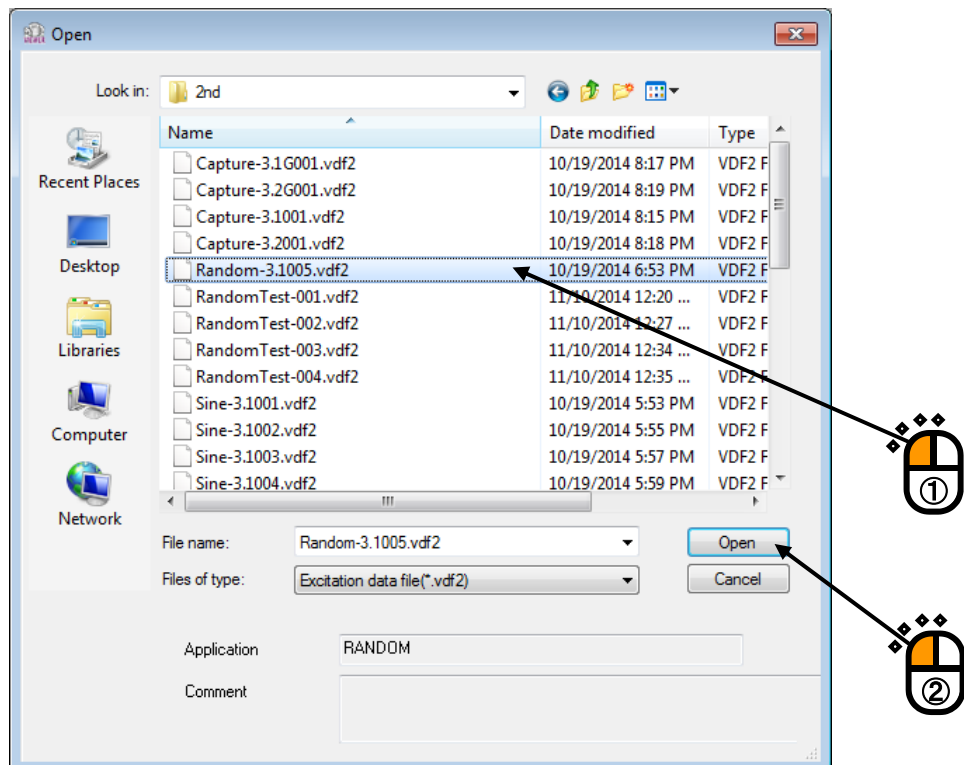



<Step 3>

Graph type selection dialog is displayed corresponding to each application software.

Select the graph to be displayed.

As for the graph type applicable to 3D graph, “Waterfall graph” or “Color map” can be selected. For details, refer to “4.3.2.1 Selecting of 3D graph”.

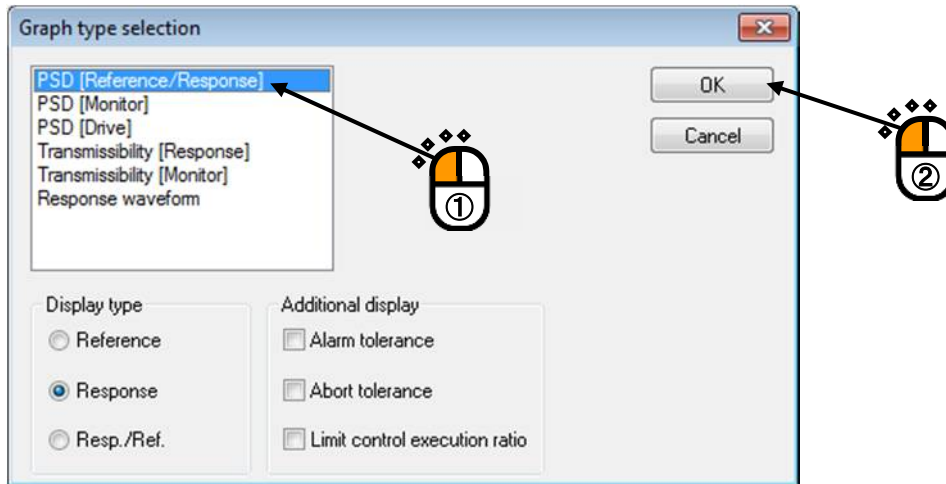

<Step 4>

A graph window is added and the selected graph is displayed.

Graphs can be operated in the same way as graphs on the application software.

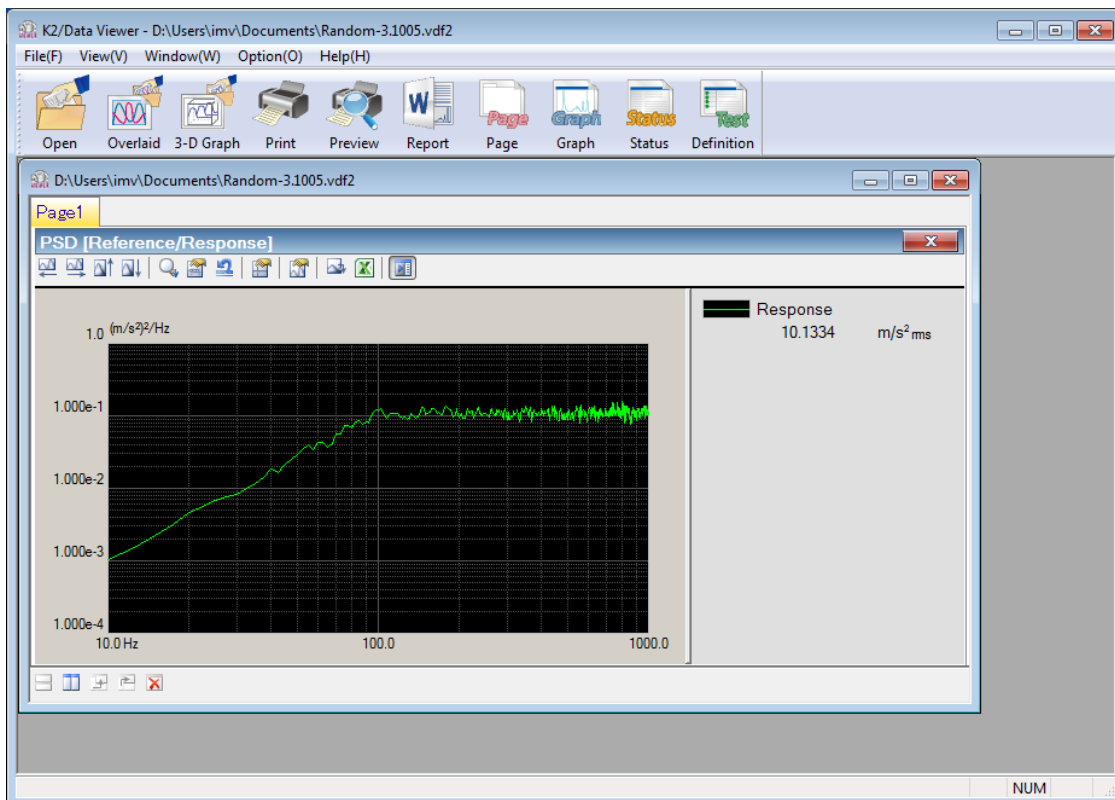

### 6.2.3 Display of Overlaid Graph

The screen to choose object data file of overlaid graph are available in tree display and dialogue display, selectable between them. Type of graph allowing overlaying differs depending on the screens.

#### 6.2.3.1 Select on Tree Display

<Procedure>

<Step 1>

Press the [Overlaid graph] button.

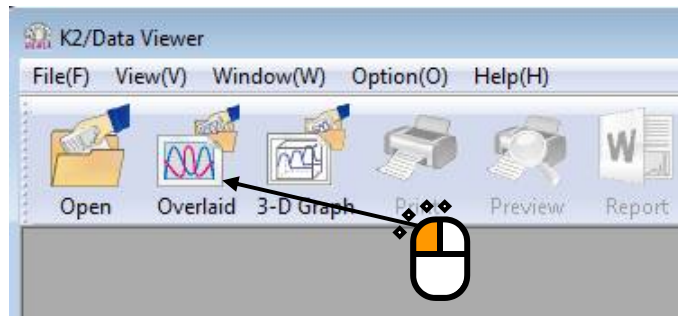

<Step 2>

Overlaid graph selection dialog is displayed.

All graph data files in the folders which were opened last time with DATA VIEWER are displayed in a tree view.

Select the graph data files to be overlaid, select the graph type and then press [Add] button.

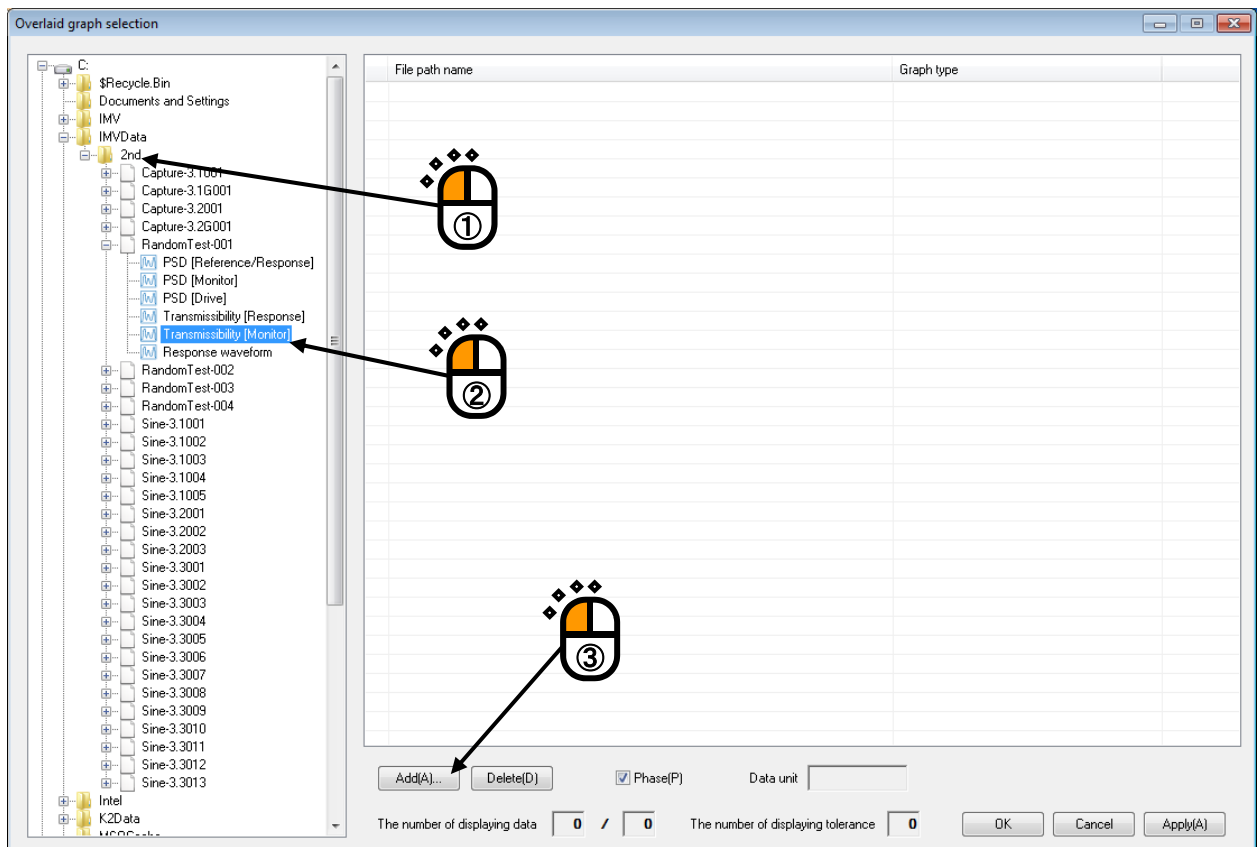

<Step 3>

Graph selection dialog is displayed corresponding to each graph type.  
Select the display conditions.

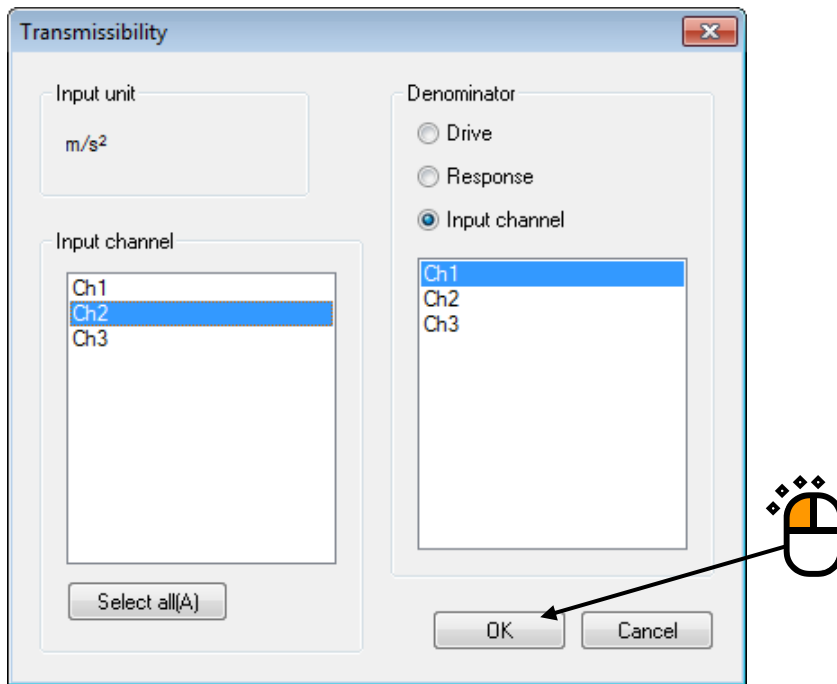

<Step 4>

The selected graphs are set to be subject to overlay operation.  
Only graphs with the same graph type and physical quantity can be overlaid.

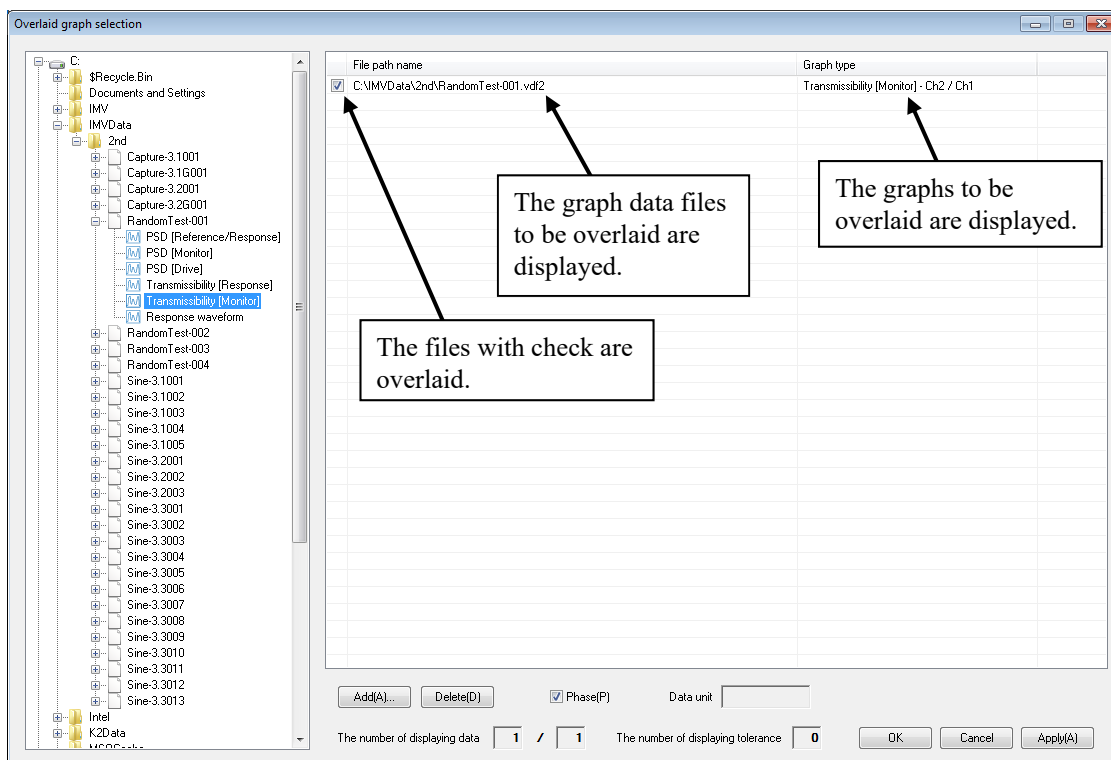

<Step 5>

Complete the set up of graphs to be overlaid and then press the [OK] button.

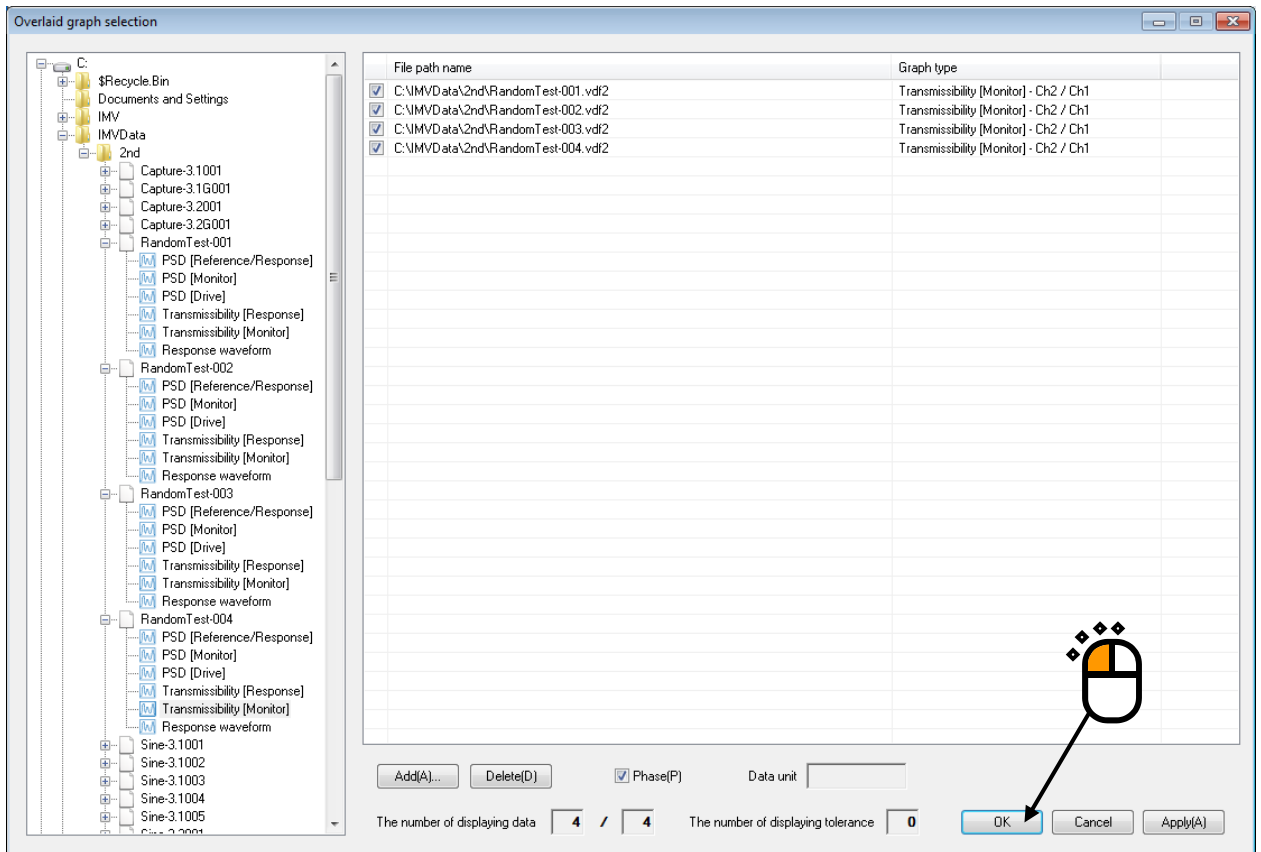

<Step 6>

A graph window is added and the selected graphs are overlaid and displayed.

Those graphs can be operated in the same way as those on the application software.

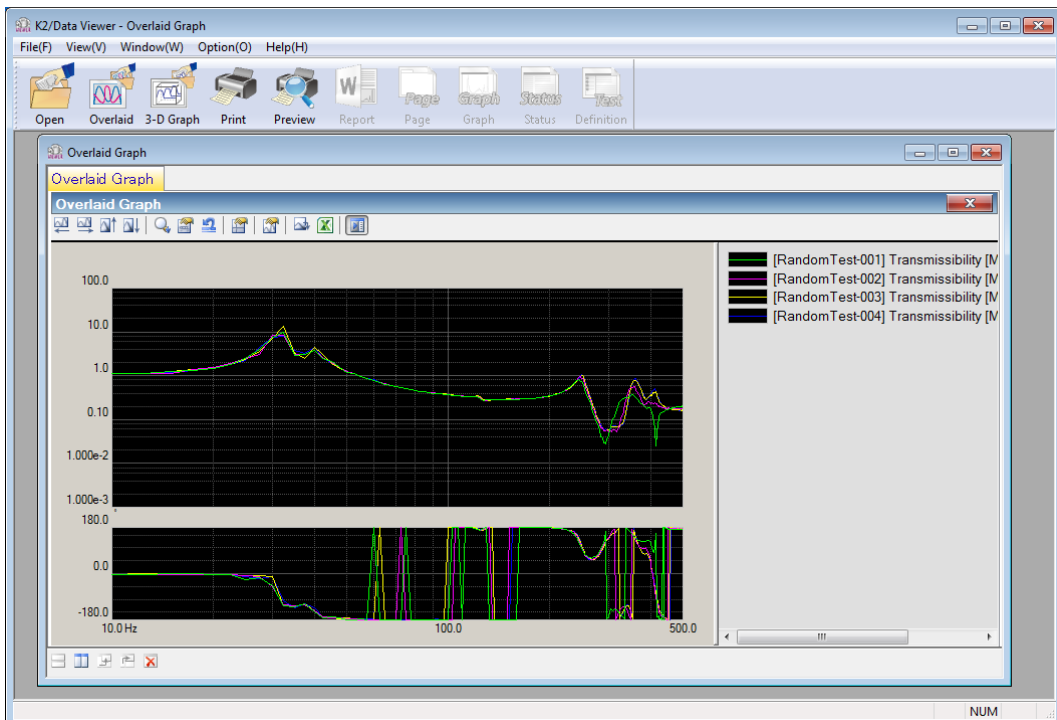

<To change the graph>

Press the [Change] button.

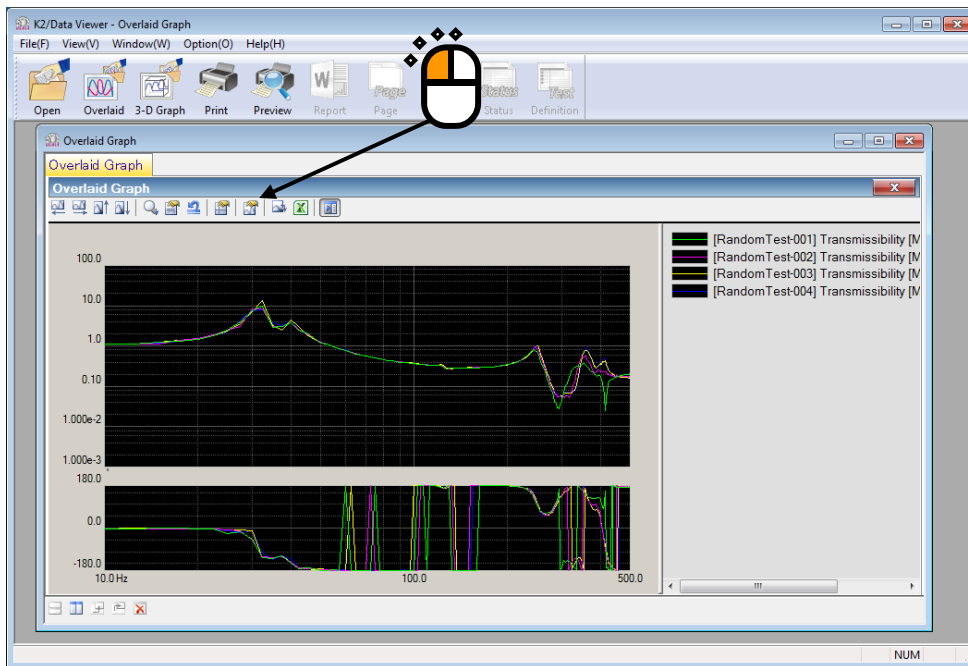

Overlaid graph selection dialog is displayed. Graphs can be added or deleted in this dialog.

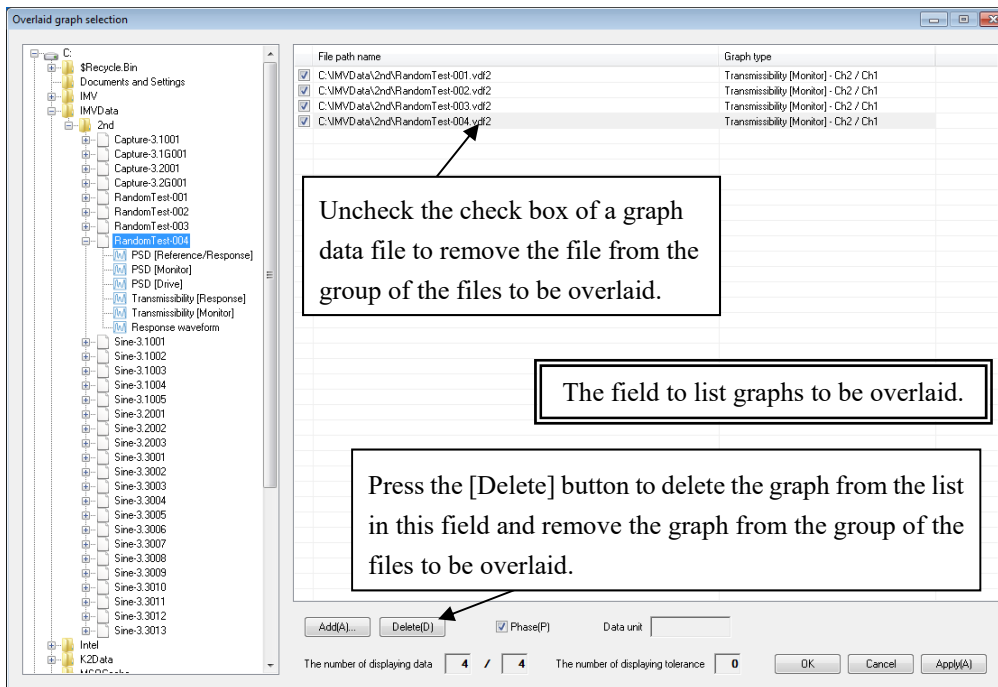

### Supplementary Note)

- [1] If the check box of a graph is unchecked, the graph is removed from the group of the graphs to be overlaid.
- [2] Select a graph and press the [Delete] button so that the graph is deleted from the list in the field and removed from the group of the graphs to be overlaid.
- [3] To display the different type of graphs, delete all graphs which are set up and then add new graphs.

### 6.2.3.2 Select on Dialogue Display

<Procedure>

<Step 1>

Press the [Overlaid graph] button.

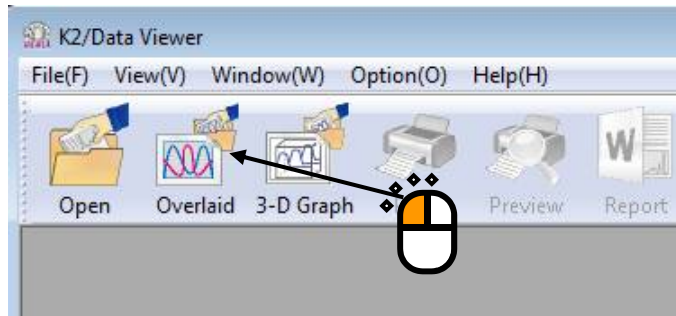

<Step 2>

Overlaid graph data selection dialogue appears. Press [Add] button.

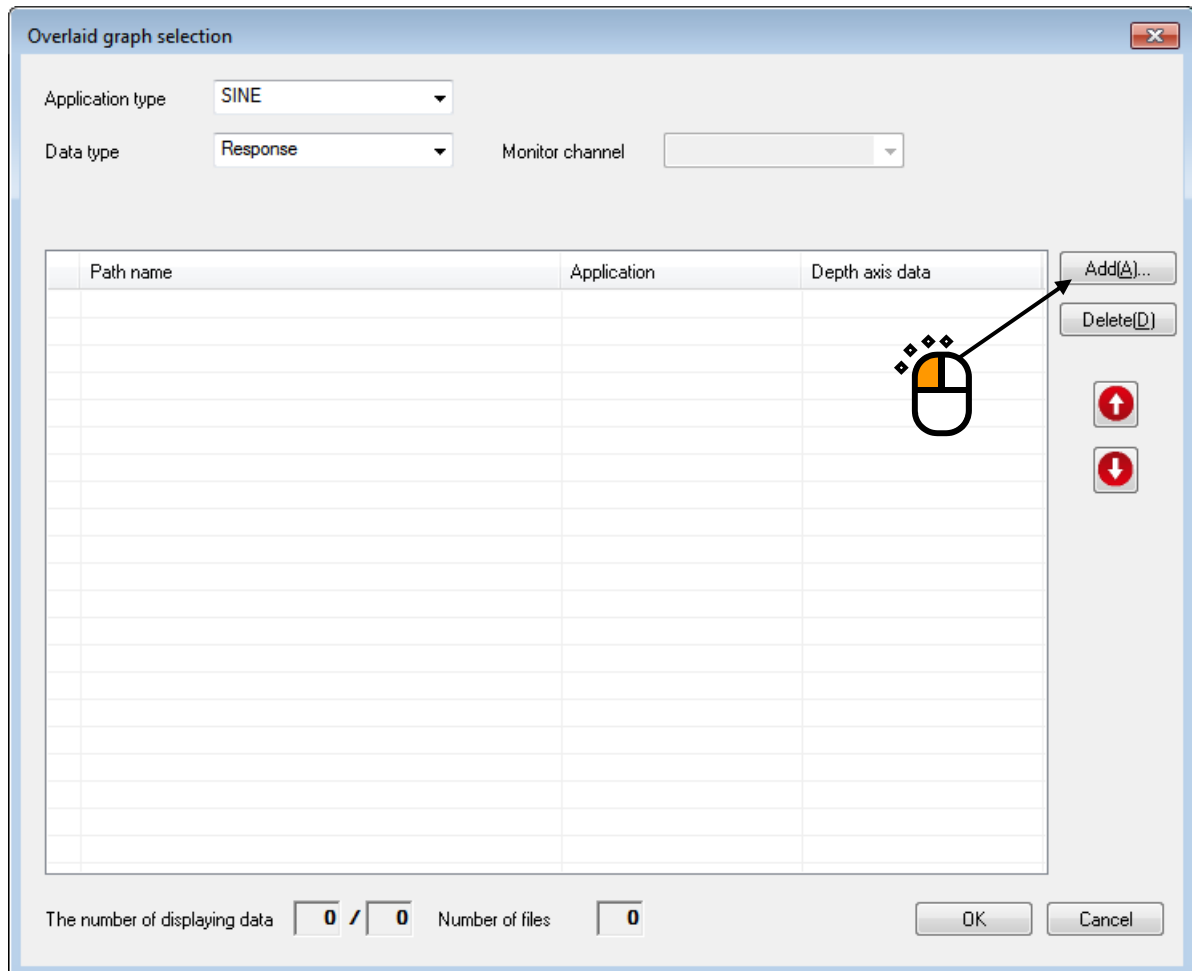

<Step 3>

Select desired data file.

(Some files can be selected at a time.)

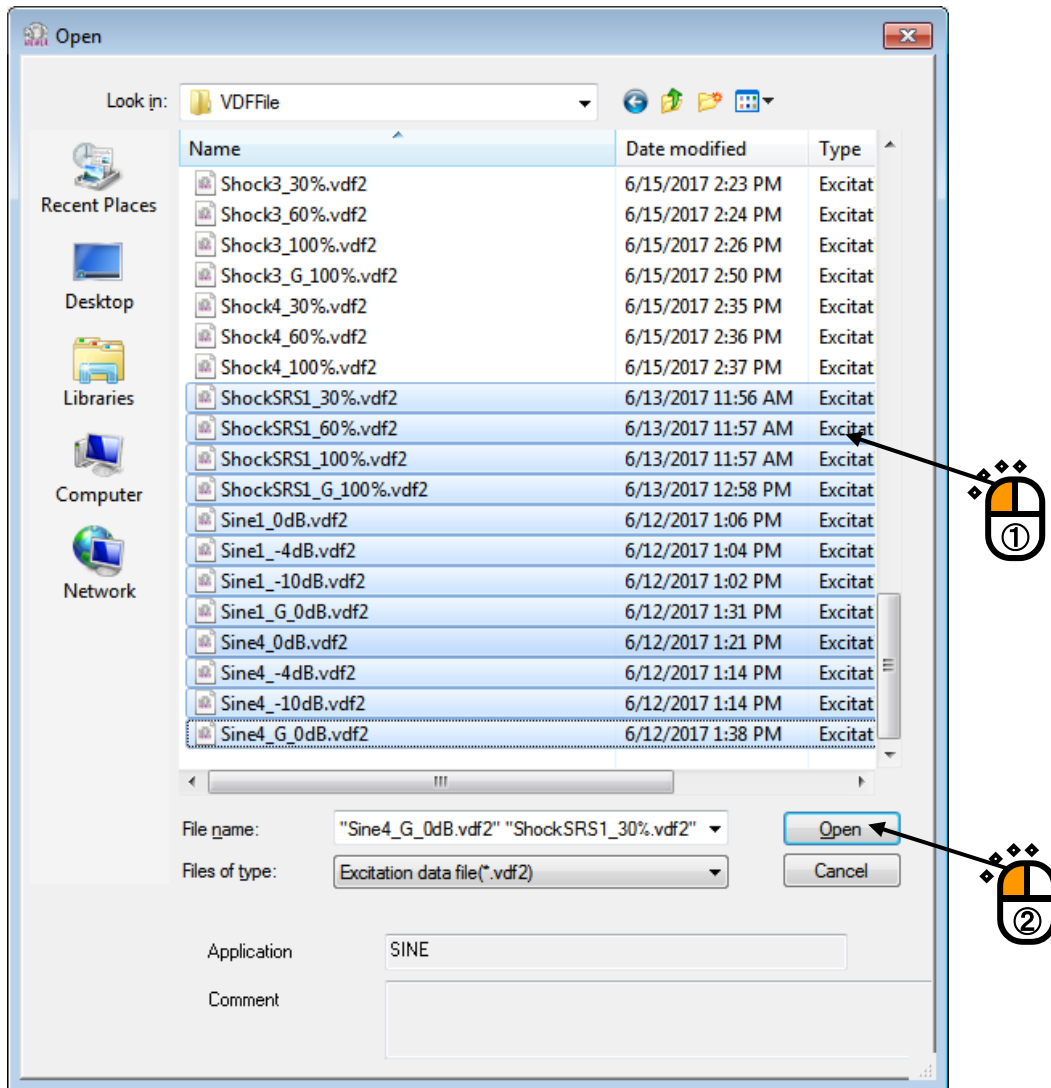

<Step 4>

Selected data files are set as the target of overlaid.

Select application type, display type and data type.

If the data type is set to “Monitor”, select the monitor channel.

If data files different from the selected application type are displayed, they are displayed in gray.

The screenshot shows the 'Overlaid graph selection' dialog box. At the top, there are three mouse icons labeled 1, 2, and 3. Arrow 1 points to the 'Application type' dropdown menu, which is set to 'SINE'. Arrow 2 points to the 'Data type' dropdown menu, which is set to 'Response'. Arrow 3 points to the 'Monitor channel' dropdown menu, which is currently empty. Below these are two buttons: 'Add(A)...' and 'Delete(D)'. There are also two red arrow buttons (up and down). The main area is a table with columns: 'Path name', 'Application', and 'Depth axis data'. The table contains several rows of data. The first three rows are grayed out, indicating they are not selected for display. The last four rows are checked with blue checkmarks and are not grayed out. Annotations with arrows point to these checked rows, stating 'Checked items are to be displayed.' and 'Graph data files to be displayed appear.' Another annotation points to the grayed-out rows, stating 'Data files whose types are different from application type are displayed in gray.' At the bottom of the dialog, there is a status bar showing 'The number of displaying data 4 / 4' and 'Number of files 8'. There are 'OK' and 'Cancel' buttons. A mouse icon labeled 4 points to the 'OK' button.

Path name	Application	Depth axis data
<input type="checkbox"/> C:\K2Data\VDFFile\ShockSRS1_30%.vdf2	SHOCK(SRS)	2017/06/13 11:56:44
<input type="checkbox"/> C:\K2Data\VDFFile\ShockSRS1_60%.vdf2	SHOCK(SRS)	2017/06/13 11:57:19
<input type="checkbox"/> C:\K2Data\VDFFile\ShockSRS1_100%.vdf2	SHOCK(SRS)	2017/06/13 11:57:41
<input type="checkbox"/> C:\K2Data\VDFFile\ShockSRS1_G_100%.vdf2	SHOCK(SRS)	2017/06/13 12:58:18
<input checked="" type="checkbox"/> C:\K2Data\VDFFile\Sine1_0dB.vdf2	SINE (Sweep)	2017/06/12 13:06:08
<input checked="" type="checkbox"/> C:\K2Data\VDFFile\Sine1_-4dB.vdf2	SINE (Sweep)	2017/06/12 13:04:46
<input checked="" type="checkbox"/> C:\K2Data\VDFFile\Sine1_-10dB.vdf2	SINE (Sweep)	2017/06/12 13:02:54
<input checked="" type="checkbox"/> C:\K2Data\VDFFile\Sine1_G_0dB.vdf2	SINE (Sweep)	2017/06/12 13:31:27

The number of displaying data  /  Number of files



<Step 5>

Graph window is added, and the selected graph appears.

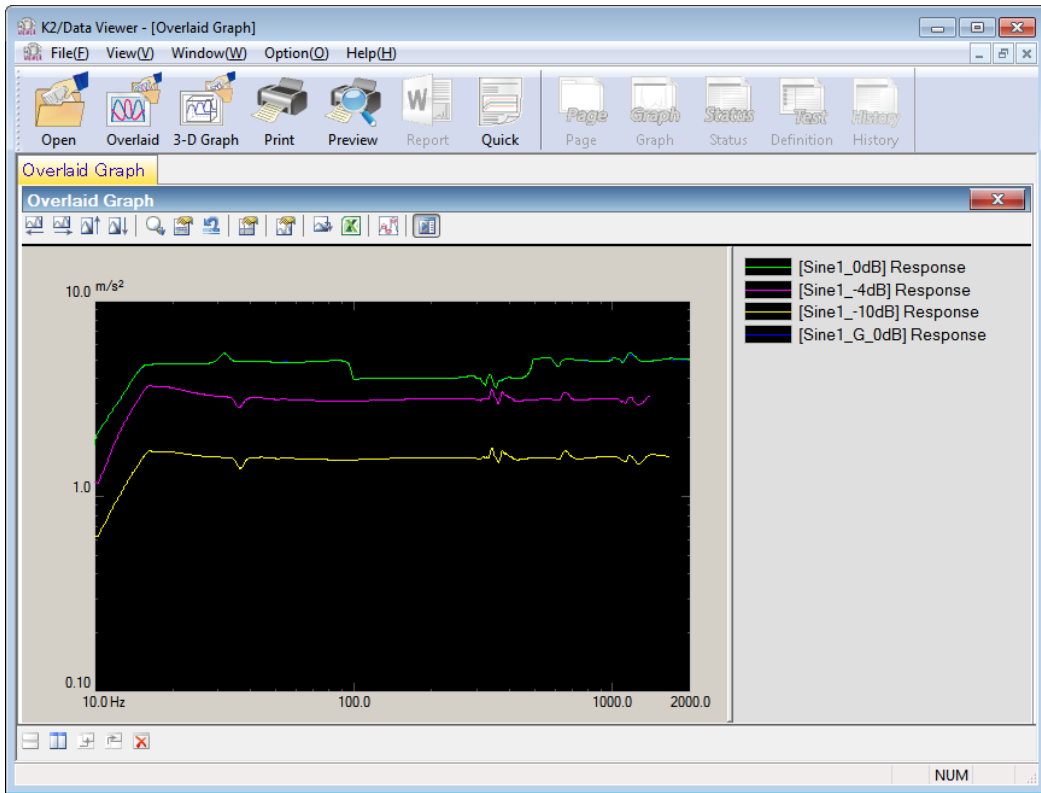

<Change of displayed graph>

Press the [graph change] button.

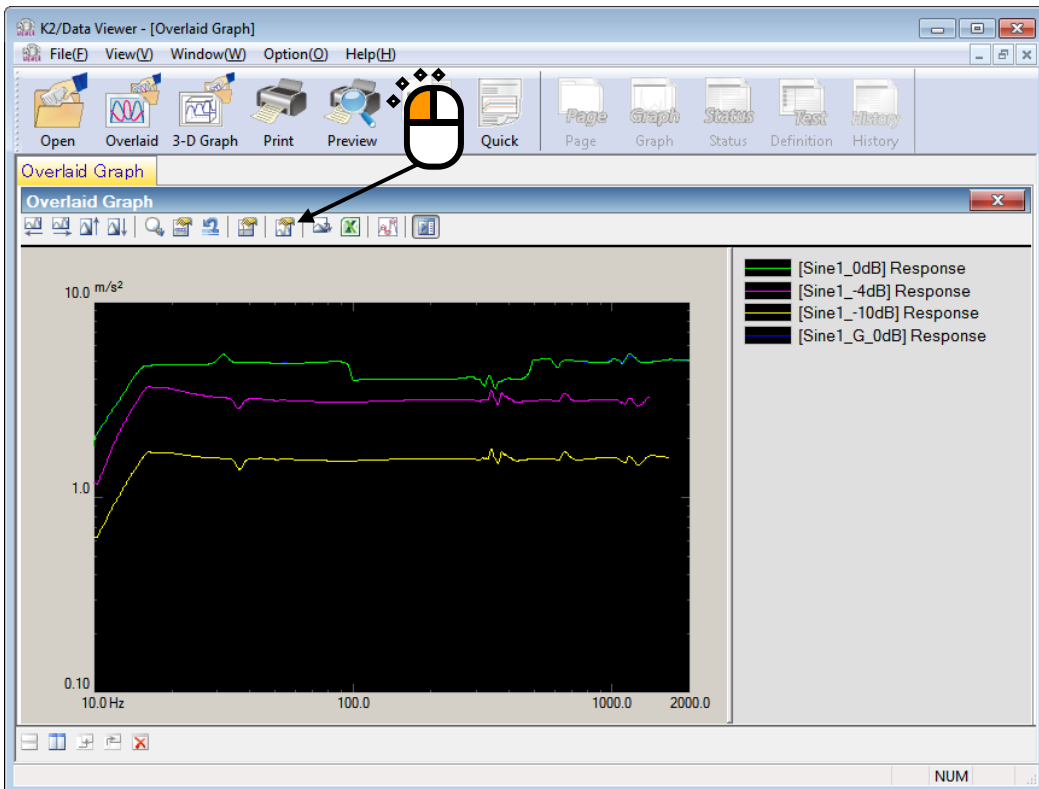

Overlaid graph data selection dialogue appears. Addition or deletion of desired graph is allowed.

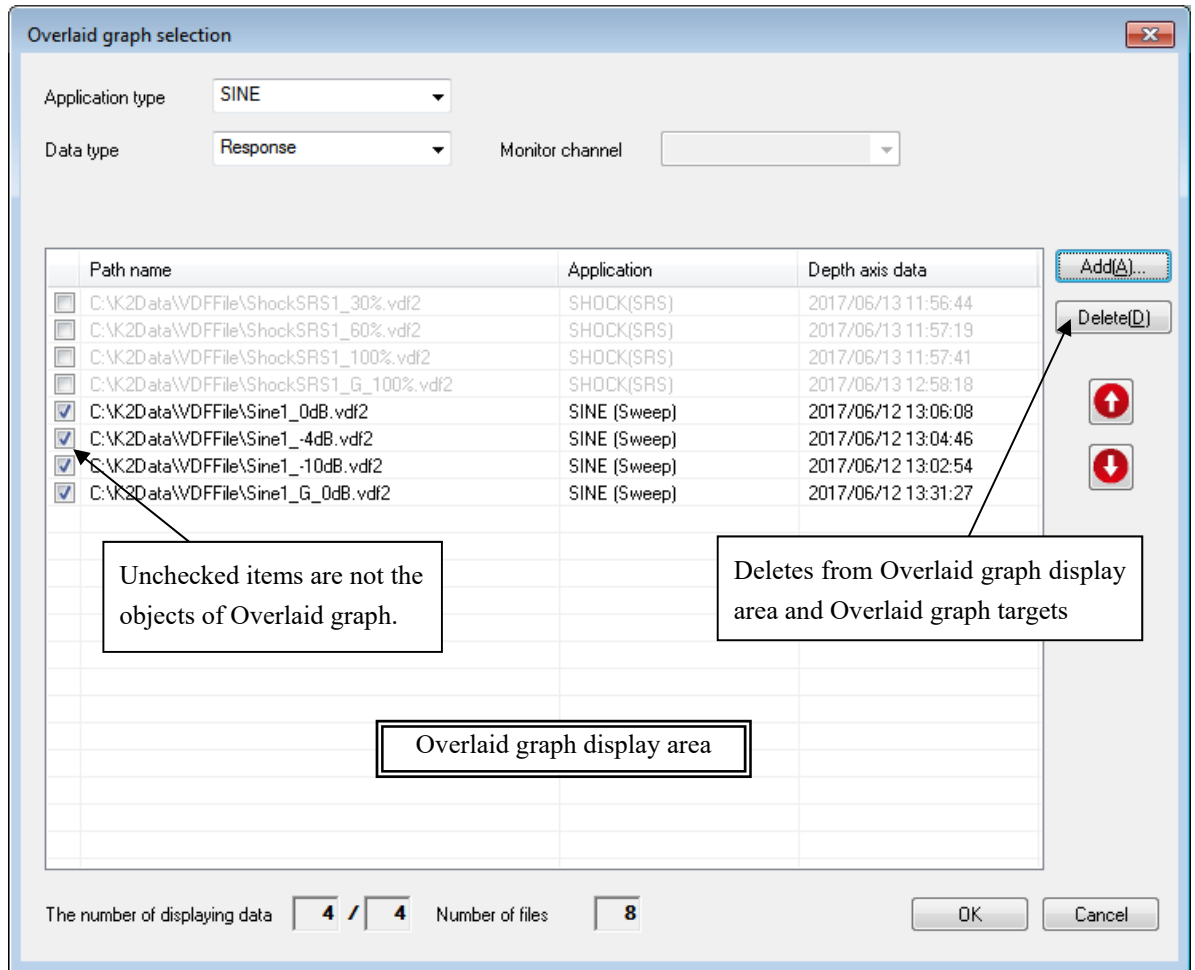

Supplementary Note)

- [1] Unchecked graphs are excluded from Overlaid graph targets.
- [2] Select desired graphs and press the [Delete] button. Then, they are deleted from the Overlaid graph display area and Overlaid graph targets.

## 6.2.4 Display of 3D graph

<Procedure>

<Step 1>

Press [3D graph] button.

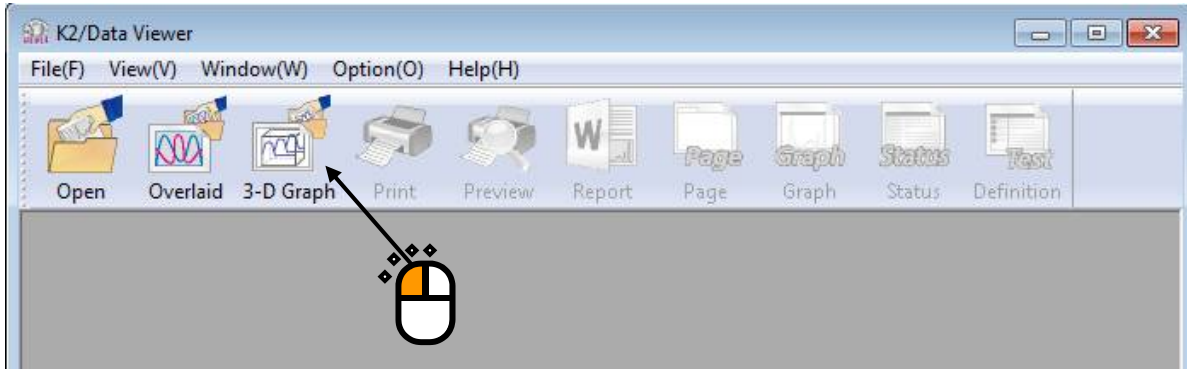

<Step 2>

3D graph data selection dialogue appears. Press [Add] button.

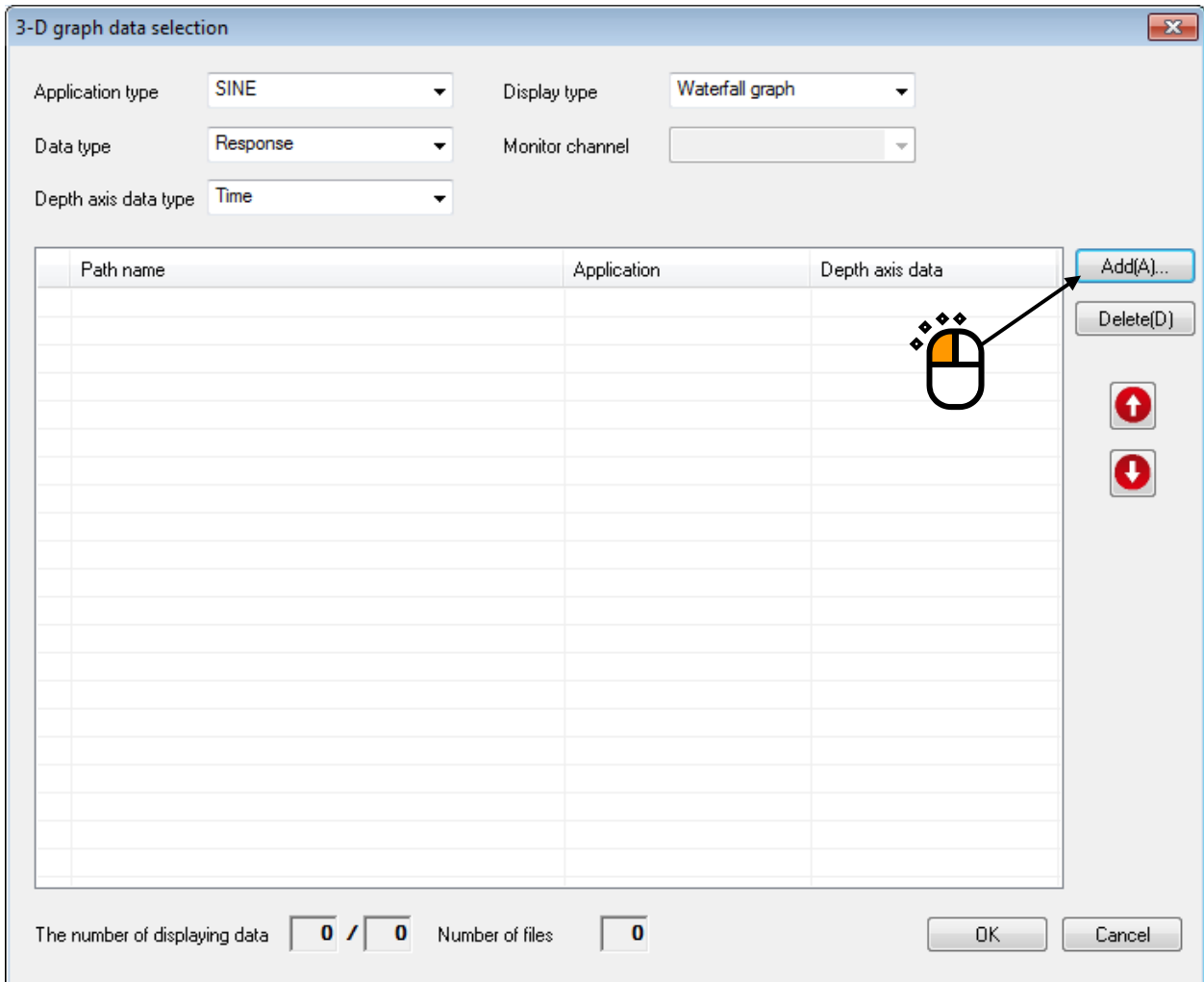

<Step 3>

Select desired data file.

(Some files can be selected at a time.)

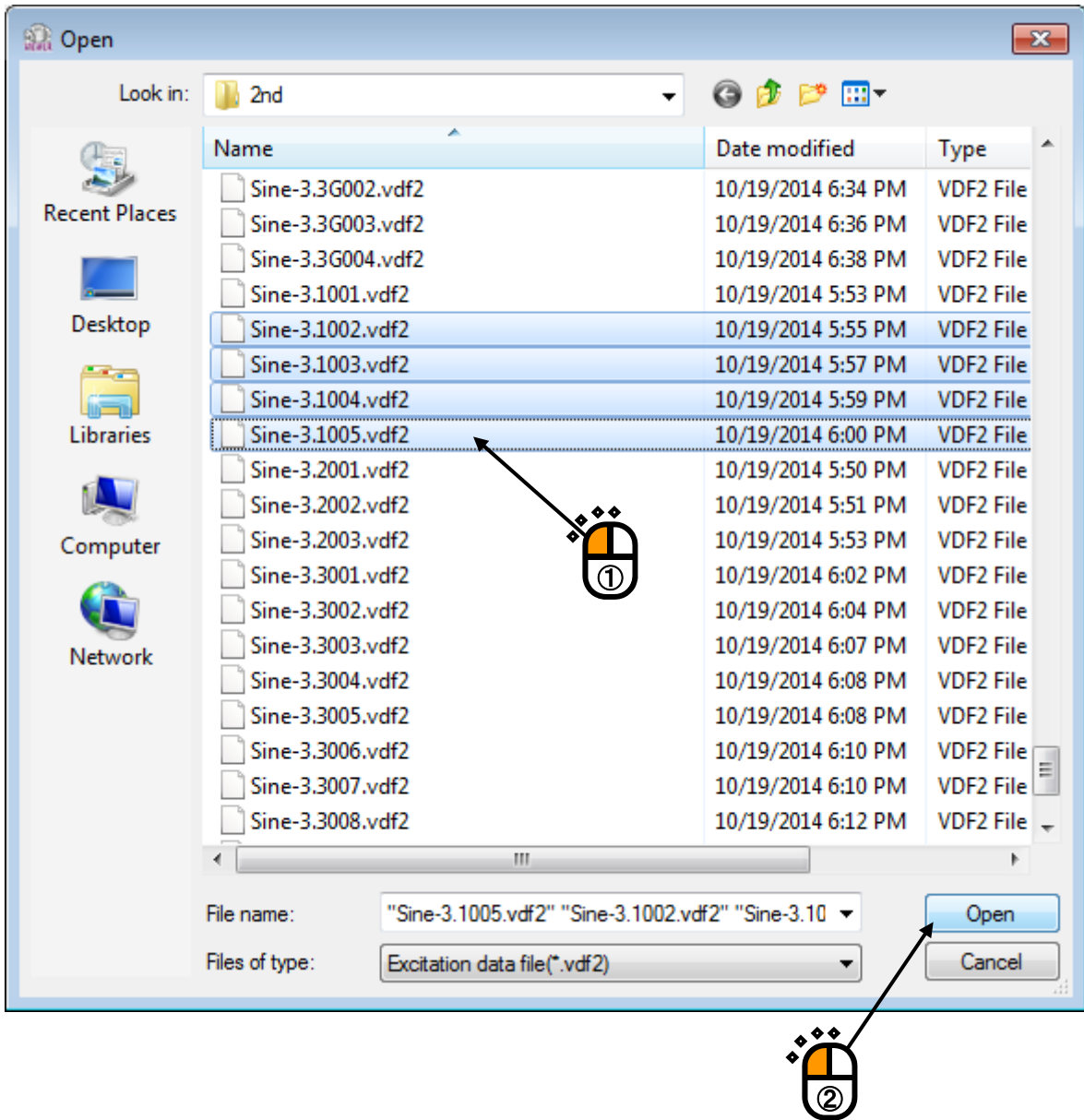

<Step 4>

Selected data files are set as the target of overlaid.

Select application type, display type, data type, and depth axis data type.

If the data type is set to “Monitor”, select the monitor channel.

If data files different from the selected application type are displayed, they are displayed in gray.

The screenshot shows the '3-D graph data selection' dialog box. It contains several dropdown menus and a table of data files. Numbered callouts (1-6) point to specific UI elements:

- 1: Application type dropdown (set to SINE)
- 2: Display type dropdown (set to Waterfall graph)
- 3: Data type dropdown (set to Response)
- 4: Depth axis data type dropdown (set to Time)
- 5: Monitor channel dropdown (empty)
- 6: OK button

The table below shows the data files being selected:

Path name	Application	Depth axis data
<input type="checkbox"/> C:\NIMVData\2nd\Random-3.1002.vdf2	RANDOM(RANDOM)	2014/10/20 10:52:16 AM
<input type="checkbox"/> C:\NIMVData\2nd\Random-3.1003.vdf2	RANDOM(RANDOM)	2014/10/20 10:52:31 AM
<input type="checkbox"/> C:\NIMVData\2nd\Random-3.1004.vdf2	RANDOM(RANDOM)	2014/10/20 10:52:46 AM
<input type="checkbox"/> C:\NIMVData\2nd\Random-3.1005.vdf2	RANDOM(RANDOM)	2014/10/20 10:52:58 AM
<input checked="" type="checkbox"/> C:\NIMVData\2nd\Sine-3.1002.vdf2	SINE (Sweep)	2014/10/20 9:55:56 AM
<input checked="" type="checkbox"/> C:\NIMVData\2nd\Sine-3.1003.vdf2	SINE (Sweep)	2014/10/20 9:57:28 AM
<input checked="" type="checkbox"/> C:\NIMVData\2nd\Sine-3.1004.vdf2	SINE (Sweep)	2014/10/20 9:59:00 AM
<input checked="" type="checkbox"/> C:\NIMVData\2nd\Sine-3.1005.vdf2	SINE (Sweep)	2014/10/20 10:00:36 AM

Annotations in the image:

- Checked items are to be displayed.
- Graph data files to be displayed appear.
- Data files whose types are different from application type are displayed in gray.

At the bottom, the status bar shows: The number of displaying data 4 / 4 Number of files 8. Buttons for Add(A)..., Delete(D), Up, Down, OK, and Cancel are also visible.

<Step 5>

Graph window is added, and the selected graph appears.

- Display example of waterfall graph

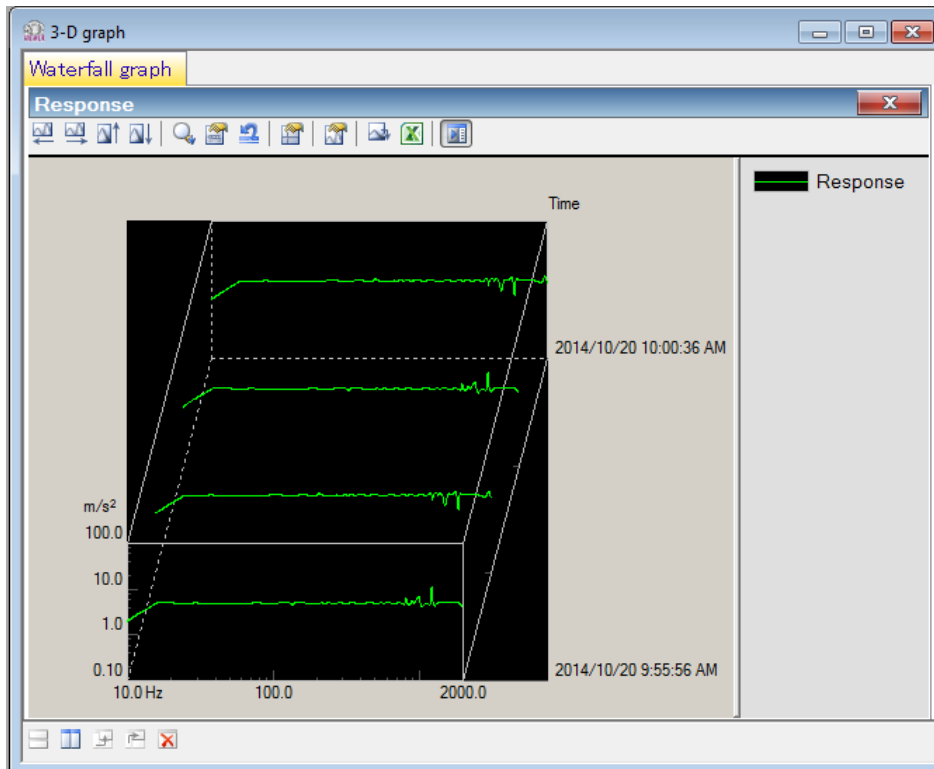

- Display example of color map

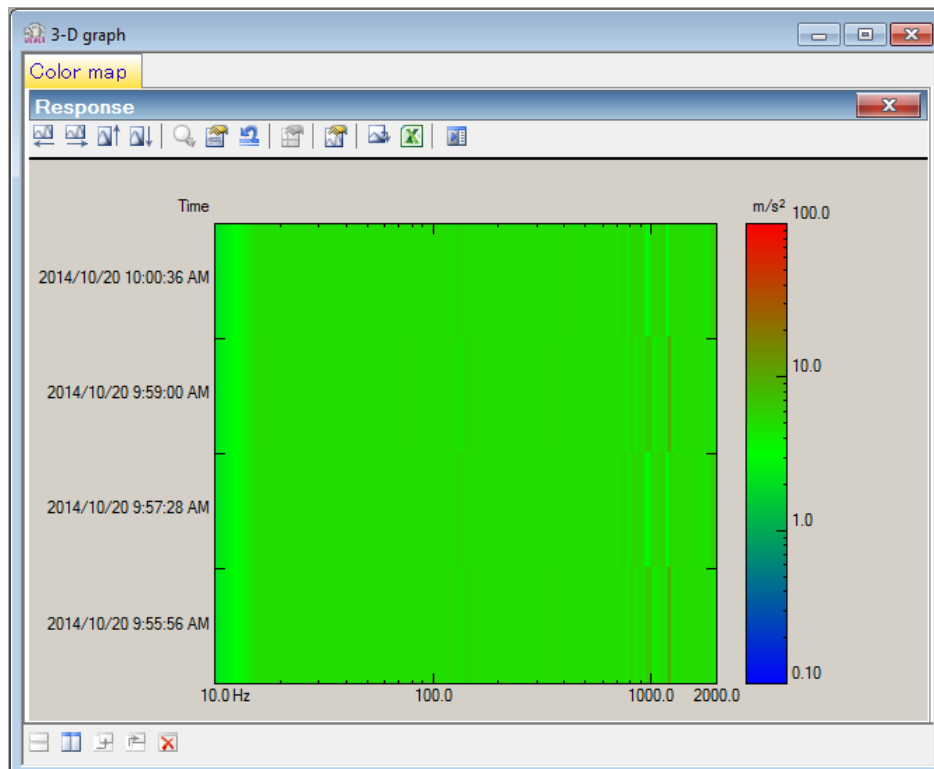

<Change of displayed graph>

Press the [graph change] button.

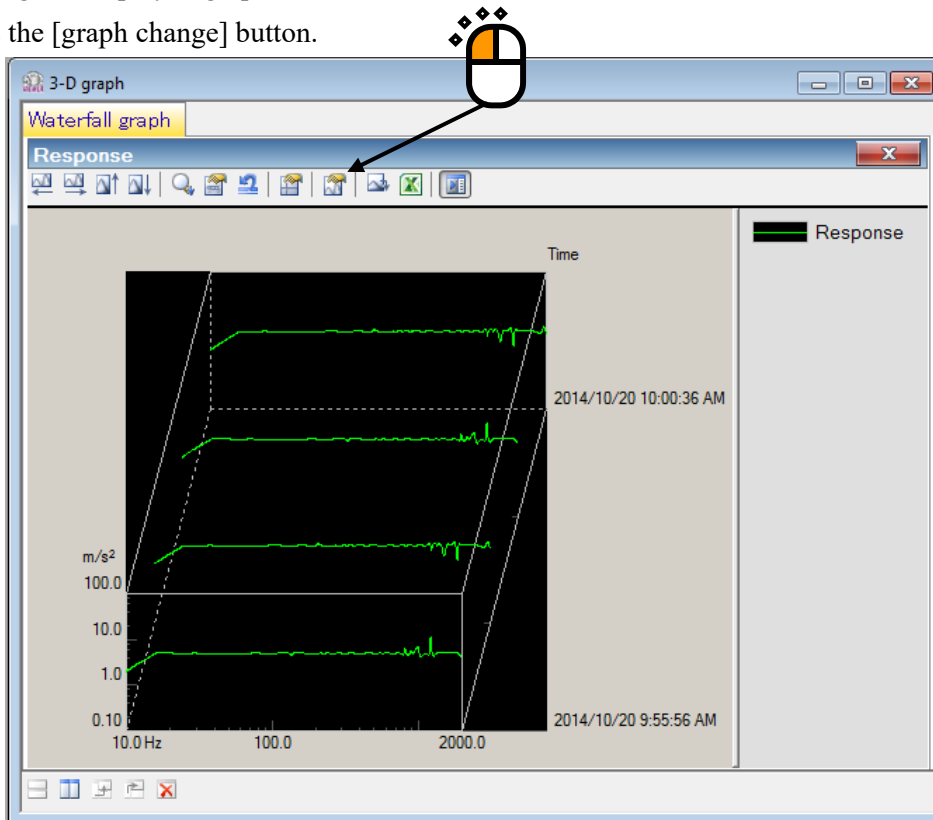

3D graph data selection dialogue appears. Addition or deletion of desired graph is allowed.

The figure shows a dialog box titled '3-D graph data selection'. It has several dropdown menus: 'Application type' set to 'SINE', 'Display type' set to 'Waterfall graph', 'Data type' set to 'Response', 'Monitor channel' (empty), and 'Depth axis data type' set to 'Time'. Below these is a table with three columns: 'Path name', 'Application', and 'Depth axis data'. The table contains several rows of data, with the last four rows checked. To the right of the table are buttons for 'Add(A)...', 'Delete(D)', and up/down arrows. A callout box points to the 'Delete(D)' button with the text 'Deletes from 3D graph display area and 3D graph targets'. Another callout box points to the unchecked items in the table with the text 'Unchecked items are not the objects of 3D graph.' A third callout box points to the table area with the text '3D graph display area'. At the bottom of the dialog, there are fields for 'The number of displaying data' (4 / 4) and 'Number of files' (8), along with 'OK' and 'Cancel' buttons.

Path name	Application	Depth axis data
<input type="checkbox"/> C:\IMVD\data\2nd\Random-3.1002.vdf2	RANDOM(RANDOM)	2014/10/20 10:52:16 AM
<input type="checkbox"/> C:\IMVD\data\2nd\Random-3.1003.vdf2	RANDOM(RANDOM)	2014/10/20 10:52:31 AM
<input type="checkbox"/> C:\IMVD\data\2nd\Random-3.1004.vdf2	RANDOM(RANDOM)	2014/10/20 10:52:46 AM
<input type="checkbox"/> C:\IMVD\data\2nd\Random-3.1005.vdf2	RANDOM(RANDOM)	2014/10/20 10:52:58 AM
<input checked="" type="checkbox"/> C:\IMVD\data\2nd\Sine-3.1002.vdf2	SINE (Sweep)	2014/10/20 9:55:56 AM
<input checked="" type="checkbox"/> C:\IMVD\data\2nd\Sine-3.1003.vdf2	SINE (Sweep)	2014/10/20 9:57:28 AM
<input checked="" type="checkbox"/> C:\IMVD\data\2nd\Sine-3.1004.vdf2	SINE (Sweep)	2014/10/20 9:59:00 AM
<input checked="" type="checkbox"/> C:\IMVD\data\2nd\Sine-3.1005.vdf2	SINE (Sweep)	2014/10/20 10:00:36 AM

Supplementary Note)

- [1] Unchecked graphs are excluded from 3D graph targets.
- [2] Select desired graphs and press the [Delete] button. Then, they are deleted from the 3D graph display area and 3D graph targets.

## 6.3 Supplemental Explanation

### 6.3.1 Set Up

<Procedure>

Select “Option” in the menu bar and click “Set up”. A dialog of ‘Set up’ appears.

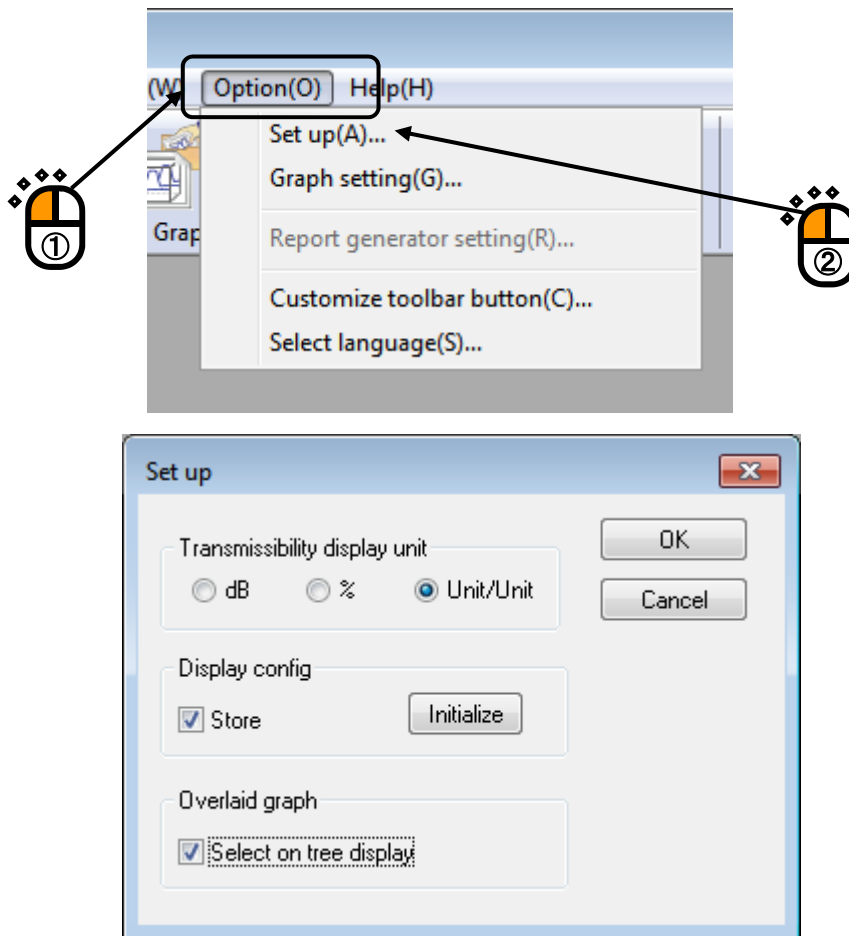

[Transmissibility display unit]

This item is for selecting the display unit of amplitude value in Transmissibility Graph.

This unit selected in this item is valid only for the transmissibility graphs calculated from the two data giving the same unit.

In case that the transmissibility graph is calculated from the two data having different units, the display unit of amplitude always appears as ‘Unit/Unit’.



[Display config. ]

- ‘Store’ check box

Check ‘Store’ to store the display configuration. Display configuration is stored for each test type.

If data file of the test type including the stored display configuration information is selected, graph selection dialogue is not displayed, but graphs are automatically displayed with the stored display configuration.

The display configuration information is updated when the display conditions including graph scales are modified.

Uncheck ‘Store’ not to store the display configuration modified thereafter.

- ‘Initialize’ button

Select ‘Initialize’ to format the display configuration.

If it is initialized, the screen configuration information of all the test types is initialized. When graph is displayed at the next time, the graph selection dialogue is displayed after data file is selected.

< Overlaid graph >

- ‘Select on tree display’ check box

Select it to choose data file in a tree display.

# Chapter 7 Launcher

## 7.1 Outline

Launcher is the software to start up the K2 application (application software) including SINE. Though the Launcher is the standard attached software, partial functions are optional.

Launcher has the three modes shown below.

- 1) 'Applications' mode
- 2) 'Standards' mode
- 3) 'Test files' mode

Note) 'Standards' mode and 'Test files' mode need standard options.

### 1) 'Applications' mode

K2 applications including SINE can be simply started.

### 2) 'Standards' mode (standard options are needed)

In this mode, test conditions can be selected in the list of standards such as ISO, and test can be executed without detailed test definition.

Operation procedures are as follows: 'Selecting standards' → 'Test reference check' → 'Test file saving'. When 'Test file saving' is executed, application is automatically started, and the hardware is initialized, and shifted to the status of waiting for excitation.

Application and test types applicable to this mode are as shown below.

Application	Test type
SINE	SINE SWEEP[sweep test](*.swp2) / SINE SPOT[spot test](*.spt2)
RANDOM	RANDOM[random](*.ran2) / SOR(*.sor2) / ROR(*.ror2)
SHOCK	SHOCK(*.sho2) / SRS SHOCK(*.srs2)
Multi-Sweep Sine	MSS FREQ[frequency division sweep](*.fds2) / MSS TIME[delay sweep](*.tis2) / MSS SPOT[multi spot](*.msp2)

### 3) 'Test files' mode (Standard option is required)

This mode allows the selection of existing test files to execute test.

Operation procedures are as follows: 'Test file selection' → 'Test reference check' → 'Test file saving'.

When 'Test file saving' is executed, application is automatically started, and the hardware is initialized, and shifted to the status of waiting for excitation.

Application and test types applicable to this mode are the same as those of the 'Standards' mode.

## 7.1.1 Precautions for 'Standards' Mode and 'Test Files' Mode

---

*Although test conditions based on the standards are input in advance in 'Standards' mode, they should be regarded as references only. When executing test, be sure to refer to the standards, and fully check the test conditions.*

---

### 7.1.1.1 Preparation

In the 'Standards' and 'Test files' modes, test files are created with using the top information registered in the excitation system information and input environment information. **Be sure to create excitation system information and input environment information** before executing the test.

For the creating procedures of excitation system information and input environment information, refer to "Chapter 3 K2 System Setting".

### 7.1.1.2 Change of Excitation System Information

When changing the information of the excitation system to be used in the 'Standards' and 'Test files' modes, change the top information of the excitation system information.

### 7.1.1.3 Limit of Control Channel

In the 'Standards' and 'Test files' modes, the test with the control channel limited to 1ch is executed.

**When executing the test such as average value control, open test files from applications and change the control channel setting.**

The modified test file can be executed in 'Test files' mode without changes.

## 7.2 Operation Example

For the startup procedures of the Launcher, refer to “4.2.1 Application Start Up” in Chapter 4. As for the finishing of the Launcher, refer to ”4.2.2 Exit from Application” in Chapter 4.

Note) If the excitation system information and input environment information have not been defined, the screen of ‘Environment setting’ appears at startup.

### 7.2.1 ‘Applications’ mode

< Procedures >

< Step 1 >

Press the button of [Applications].

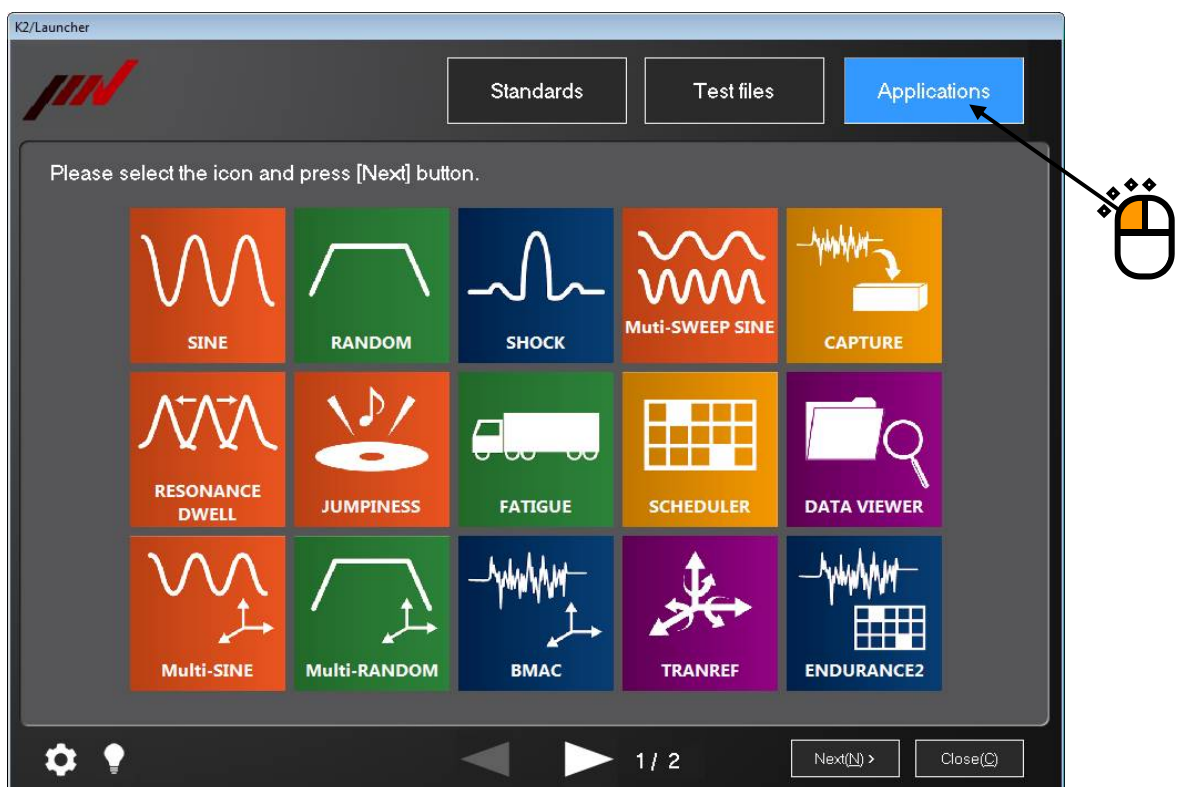

< Step 2 >

The list showing the icons of applications installed is displayed.

Select the icon of application to be started up, and press the button of [Next].



When number of the installed K2 application is more than twelve, the remaining icons can be displayed by pressing the bottom of arrow in the lower part of screen.

< Step 3 >

The screen of the application being started up appears.

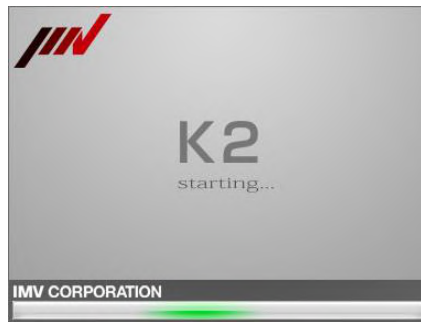

The selected application starts up. As for the later operating procedures, refer to the instruction manual of the applications.

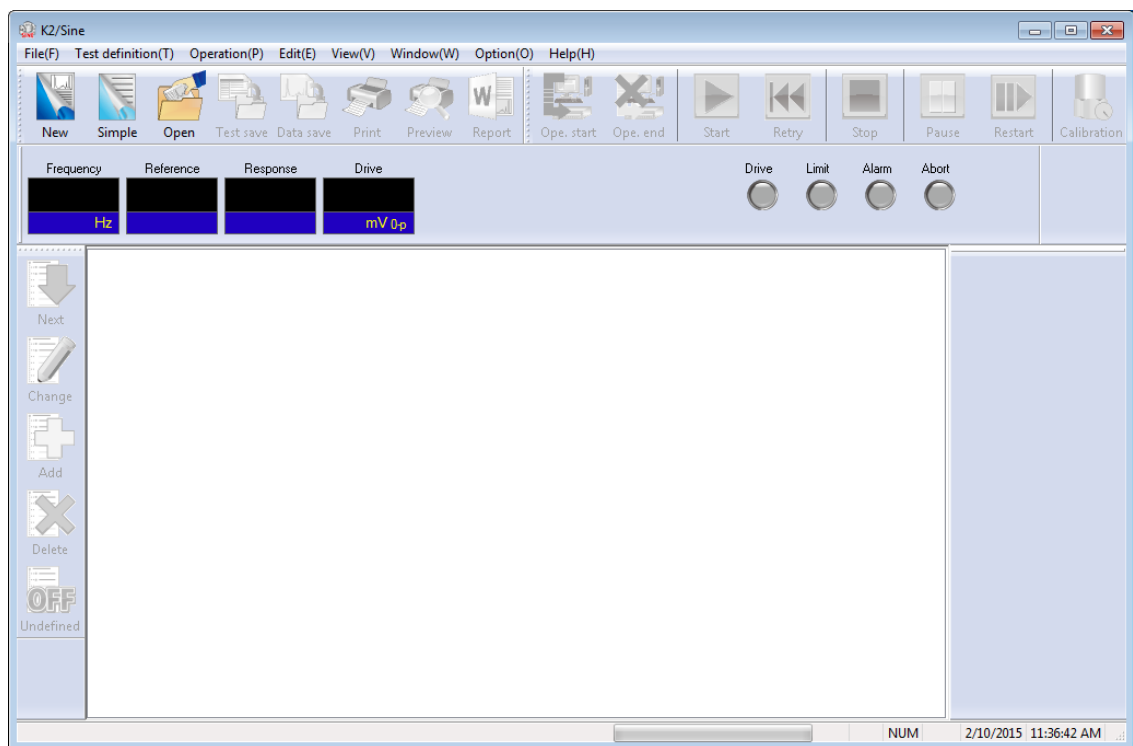

## 7.2.2 'Standards' Mode

< Procedures >

< Step 1 >

Press the button of [Standards].

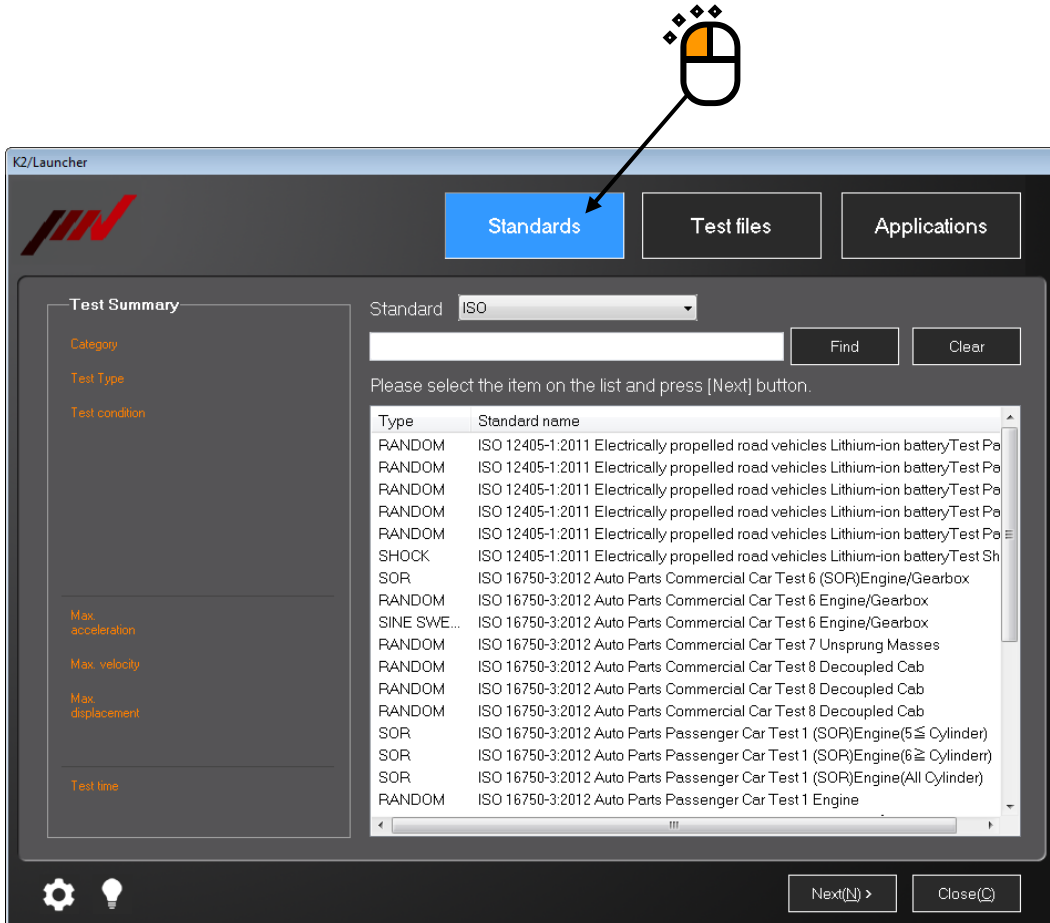

< Step 2 >

Select any 'Standard', and choose any standard name in the standard list.

After the 'Standard name' is selected, press the button of [Next].

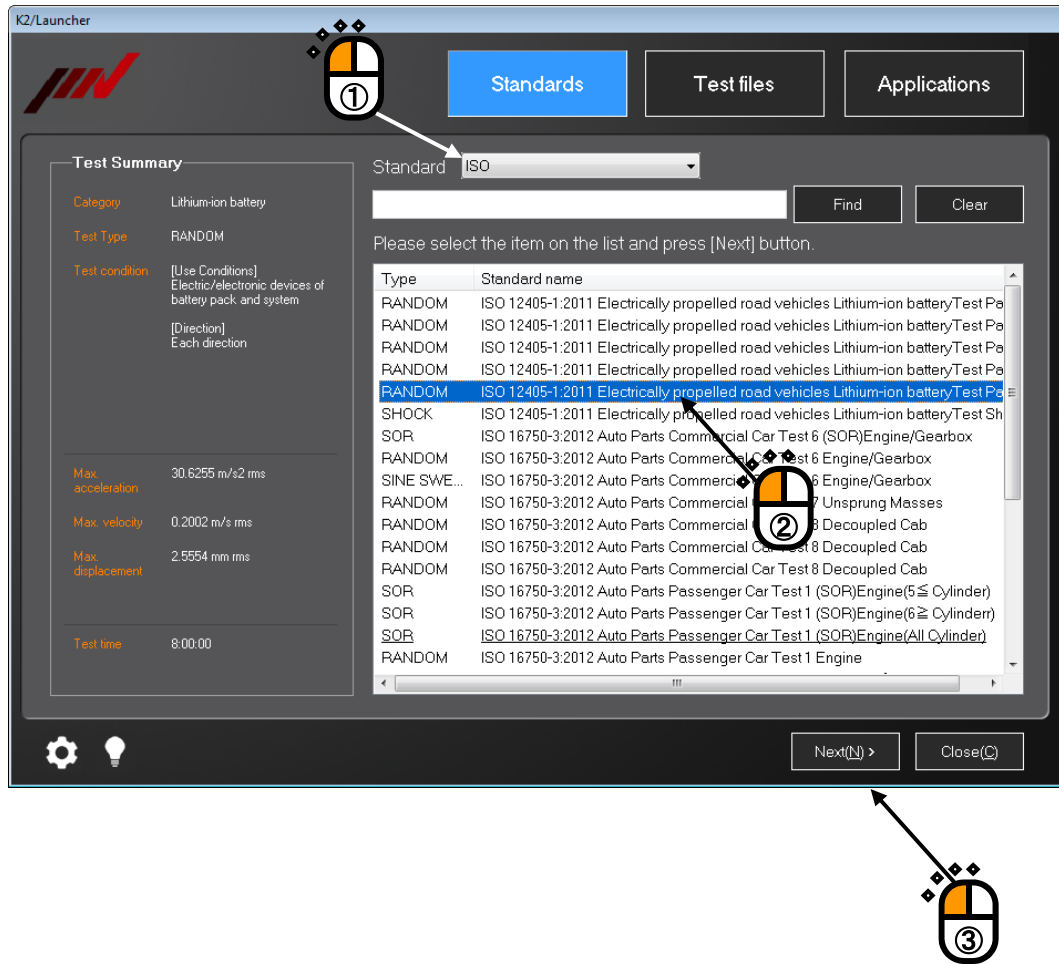



< Step 3 >

Test reference check screen appears. This screen depends on the test types.

This example shows the test type of RANDOM.

Items related to the test time and those related to the control channel can be changed here.

Change them if required, and press the button of [Next].

The test reference graph is displayed.

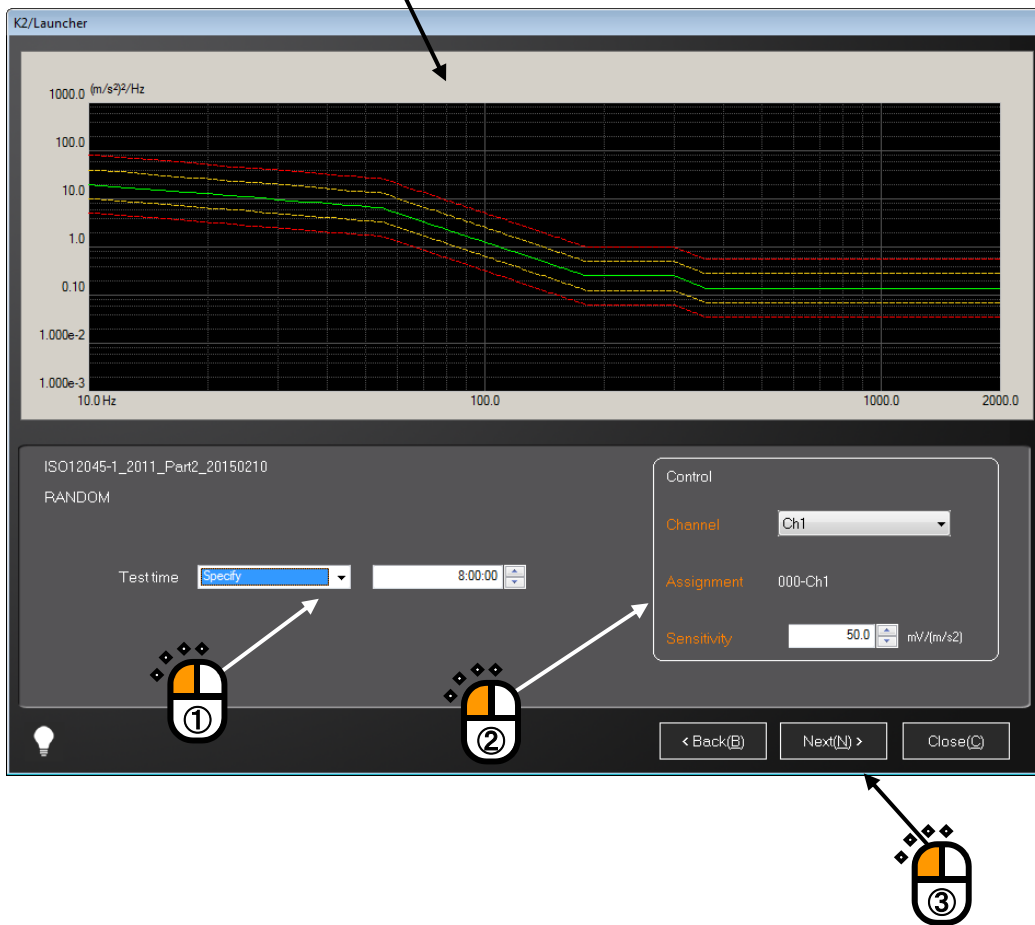

< Step 4 >

The test file saving screen appears.

Select the save location folder, enter file name, and press the button of [Save].

If any existing file is included, the message of confirming overwriting appears.

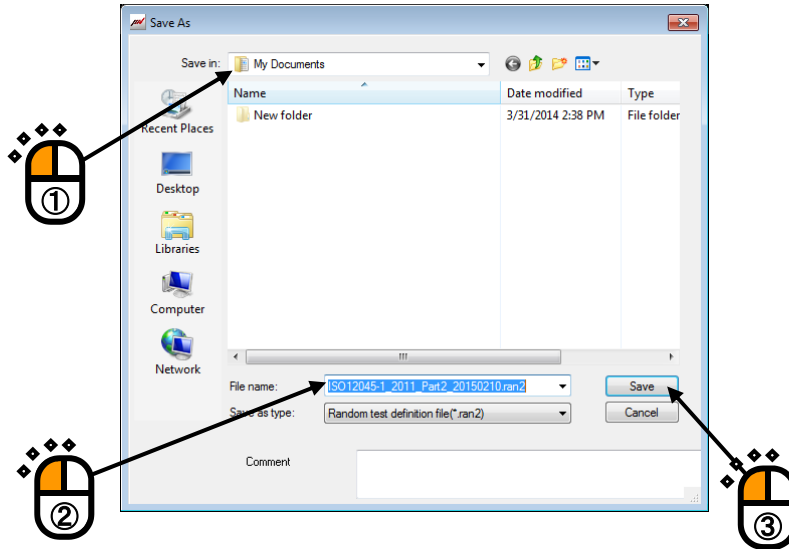

< Step 5 >

The screen noticing the startup of application appears.

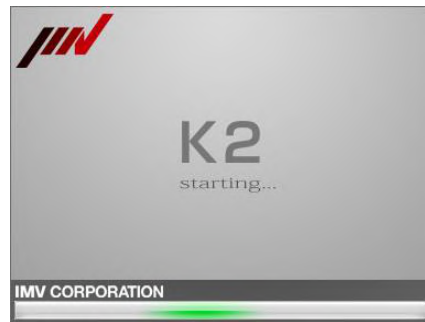

After the application is started, test files are read in, and the hardware initialization is automatically complete. As for the later operation procedures, refer to the instruction manual of applications.

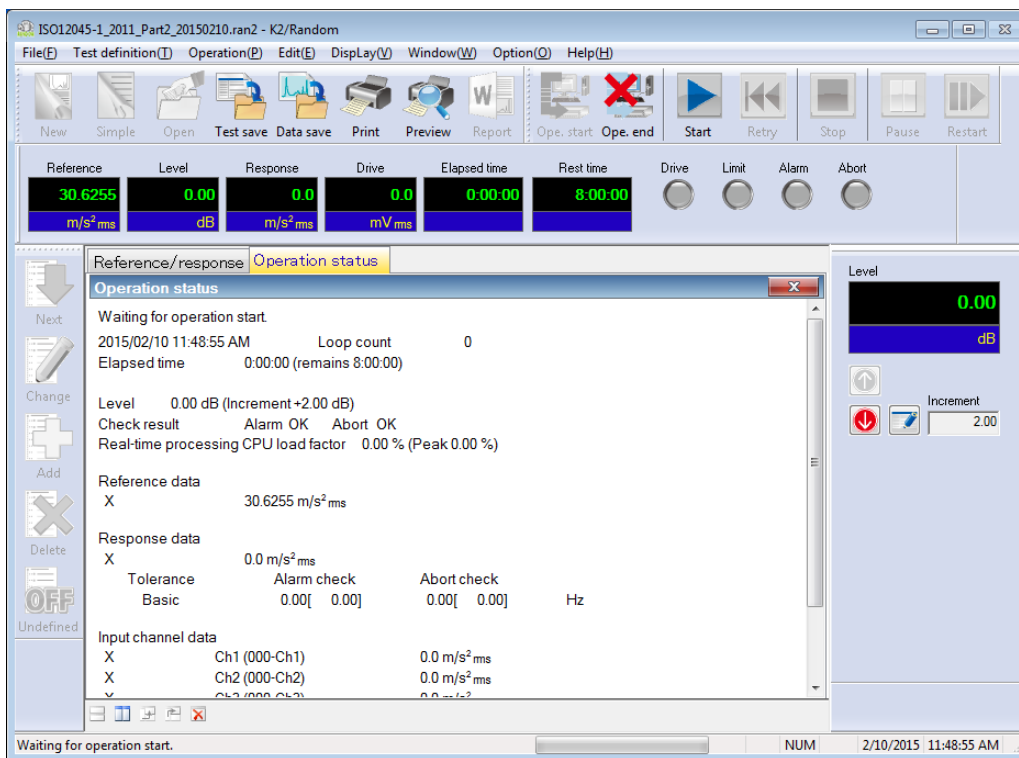

Note) Main errors during execution

- When definition error occurs  
After application is started up\*, definition error occurs, and the definition is completed.
- In case there is application of which test is being executed  
After application is started up\*, execution start process fails, and the definition is completed.  
There will be no influence on the test being executed.
- \* ) If the same application is started up in the 'Standards' and 'Test files' modes, no more application will be newly started up.

### 7.2.3 'Test files' mode

< Procedures >

< Step 1 >

Press the button of [Test files].

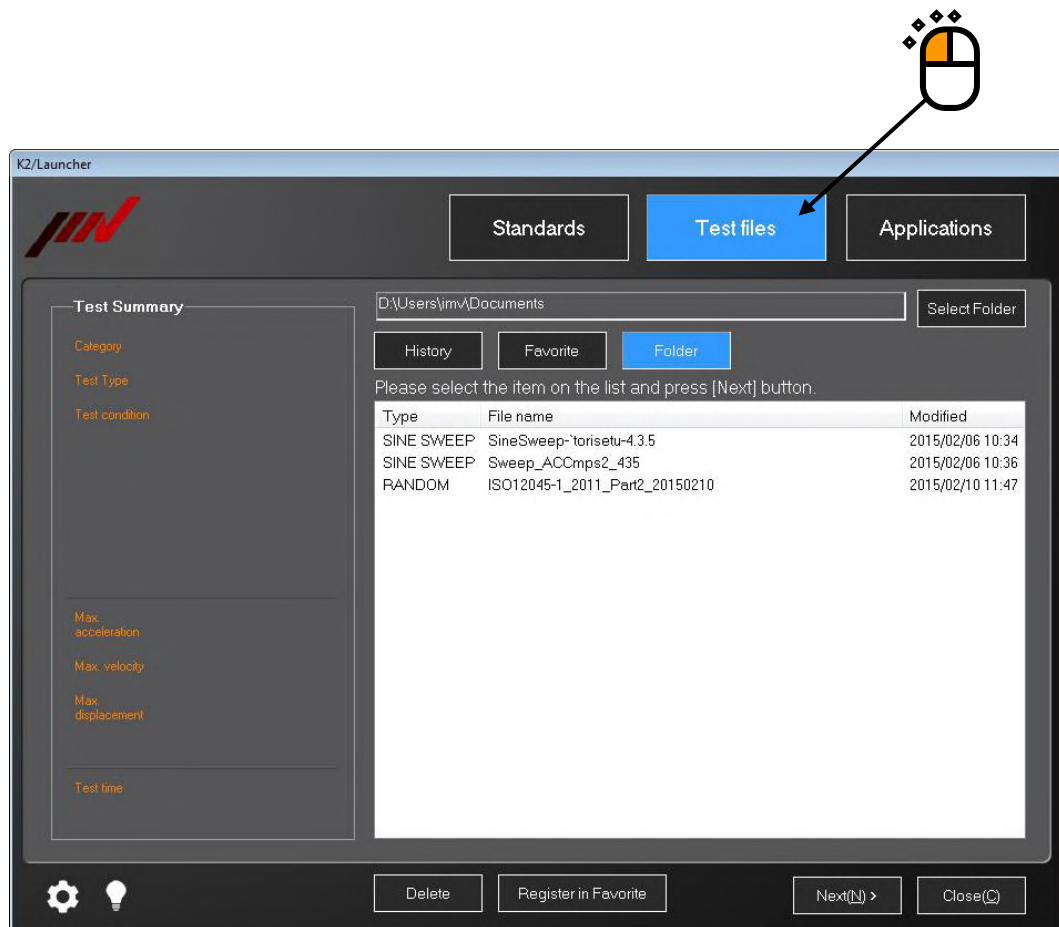

< Step 2 >

Press any of the buttons of 'History', 'Favorite', or 'Folder'.

In this example, 'Folder' is selected.

Select any test file displayed in the list.

After your desired test file is selected, press the button of [Next].

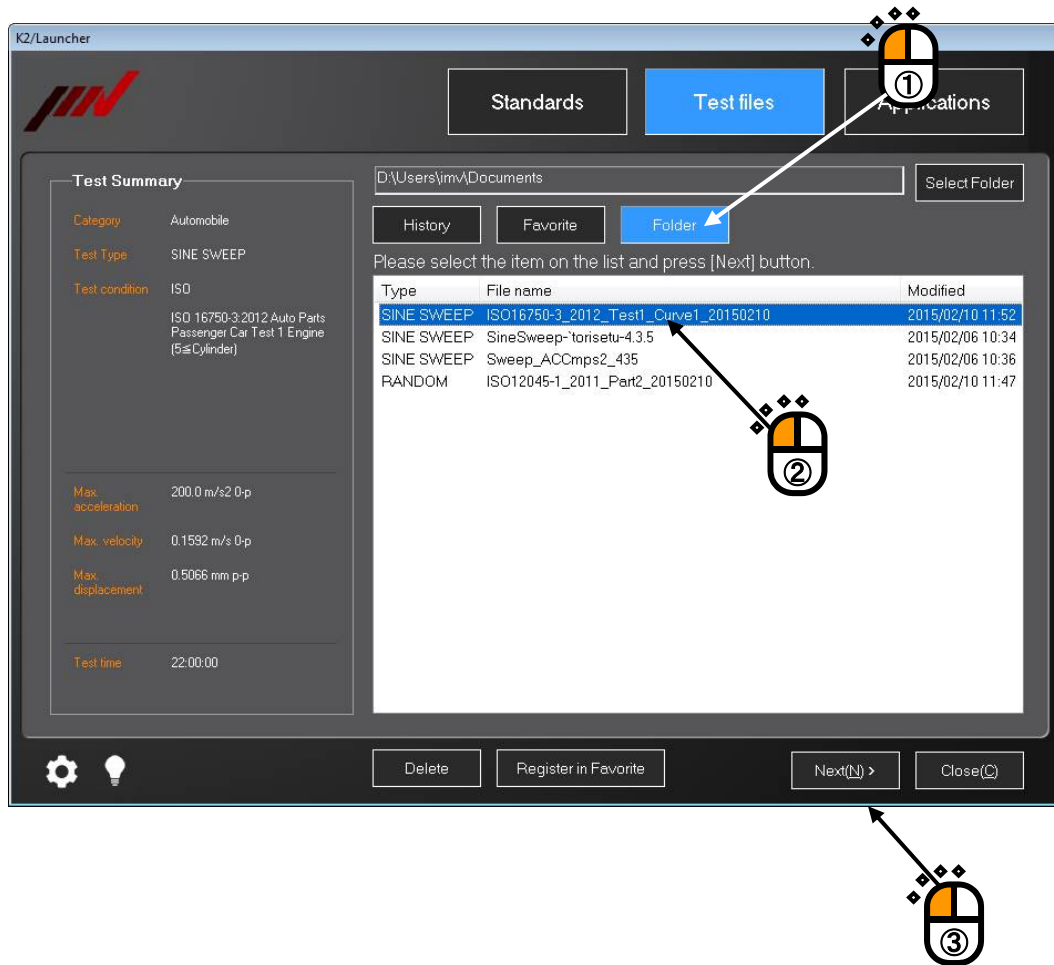

< Step 3 >

The test reference check screen appears. The screen differs according to the test types.

This example shows the test type of SINE SWEEP.

Items related to the test time and those related to the control channel can be changed here.

Change them if required, and press the button of [Next].

Test reference graph is displayed.

The screenshot displays the K2/Launcher software interface. At the top, a graph shows the test reference with acceleration in  $m/s^2$  on the y-axis (log scale from 10.0 to 1000.0) and frequency in Hz on the x-axis (linear scale from 100.0 to 440.0). The graph contains several colored lines (red, yellow, green) representing different test curves. Below the graph, the test configuration is shown for 'ISO16750-3\_2012\_Test1\_Curve1\_20150210' and 'SINE SWEEP'. The 'Sweep mode' is set to 'Log' and 'Forward-double'. The 'Sweep rate' is 0.50 octave/min, resulting in a duration of 4.2750 min/single-sweep. The 'Test time' is set to 'By time' with a value of 22:00:00. The 'Control' section shows 'Channel' set to 'Ch1', 'Assignment' set to '000-Ch1', and 'Sensitivity' set to 50.0 mV/(m/s<sup>2</sup>). Navigation buttons at the bottom include '< Back(B)', 'Next(N) >', and 'Close(C)'. Three numbered mouse icons (1, 2, 3) are overlaid on the interface: icon 1 points to the 'Test time' field, icon 2 points to the 'Channel' dropdown, and icon 3 points to the 'Next(N) >' button.

< Step 4 >

The test file saving screen appears.

Select the save location folder, enter file name, and press the button of [Save].

If any existing file is included, the message of confirming overwriting appears.

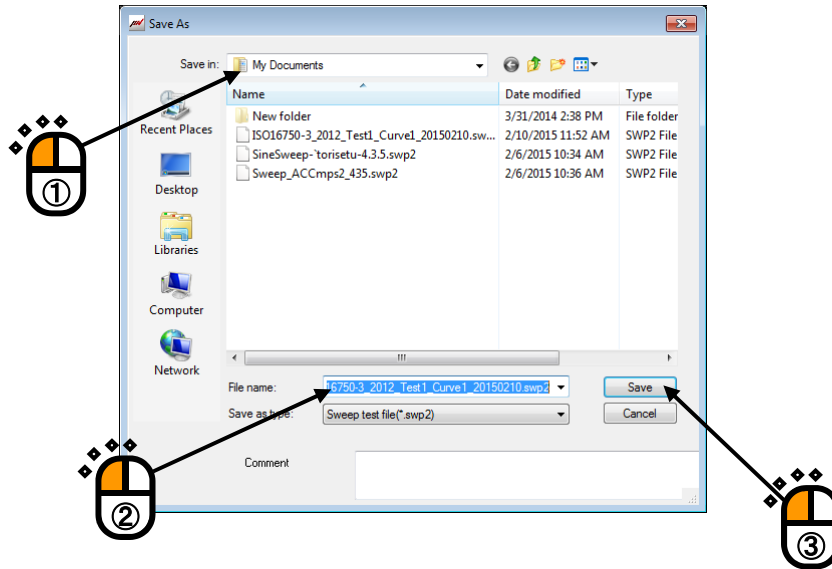

< Step 5 >

The screen noticing the starting of application appears.

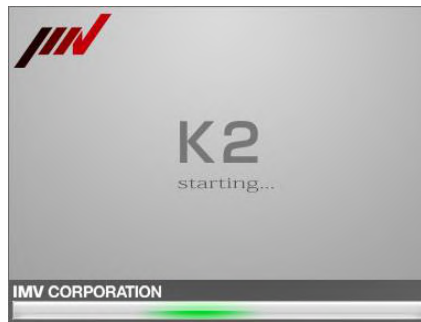

After the application is started, test files are read in, and the hardware initialization is automatically complete. As for the later operation procedures, refer to the instruction manual of applications.

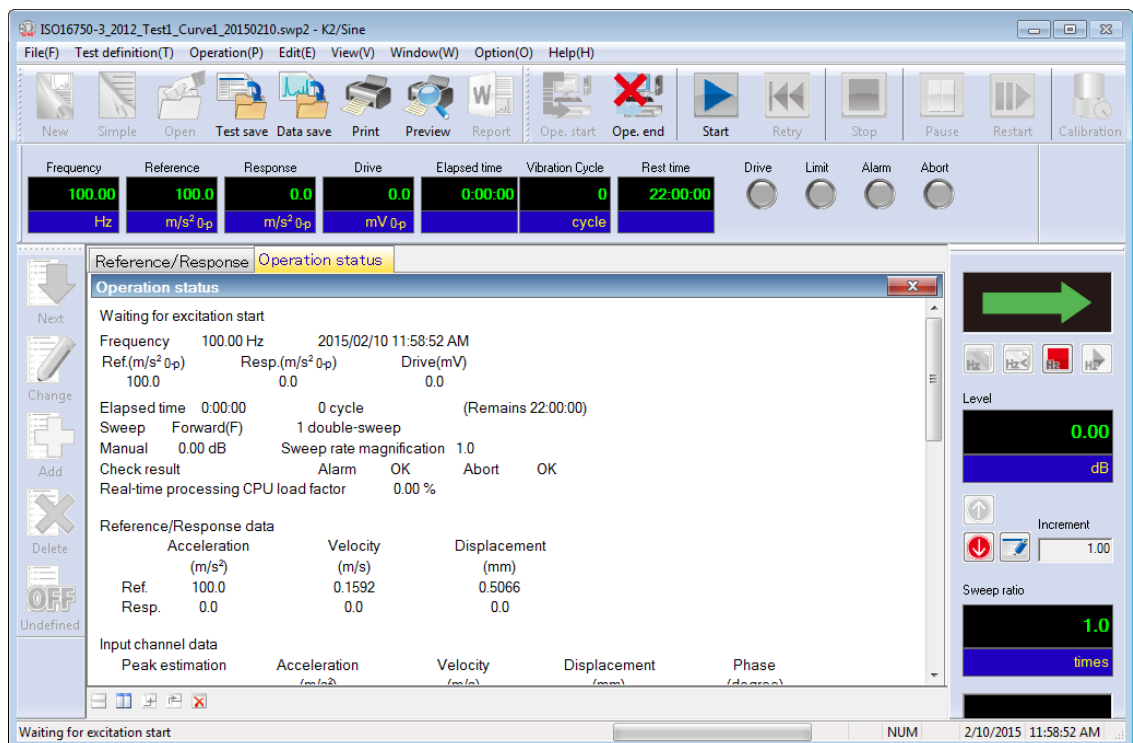

Note) Main errors during execution

- When definition error occurs  
After application is started up\*, definition error occurs, and the definition is completed.
- In case there is application whose test is being executed  
After application is started up\*, execution start process fails, and the definition is completed.  
There will be no influence on the test being executed.
- \* ) If the same application is started up in the 'Standards' and 'Test files' modes, no more application will be newly started up.



## 7.3. Supplementary Explanation

### 7.3.1 Registration and Deletion of Standard Items

Test files in the test types applicable to the 'Standards' mode can be registered as standard items. The registered standard items are recorded as the standard of 'Others' in the 'Standards' mode.

#### 7.3.1.1 Registration of Test Files as Standards

Standard items can be registered through the individual applications.

< Procedures >

< Step 1 >

In the status of definition completion of individual applications, select 'File', then 'Register as standard' in the menu.

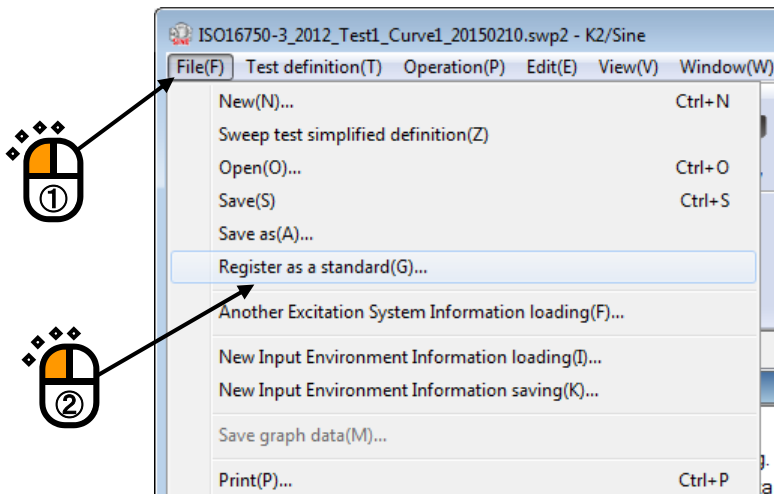

< Step 2 >

Input standard name, field, and test conditions, and press the button of [Register].

If the same standard name is found, the message noticing the overwriting registration appears.

- Note)
- Even if test files registered as standards are changed after registration, the change will not be reflected to the standards.
  - In the test conditions registered as standards, information to be added after text is executed (continuous operation data, transfer function data, drive data, etc.) is deleted.
  - If test files executing average value control and limit control are registered as standards, those information will not be taken over.

Any standard items registered already are displayed in the display area.

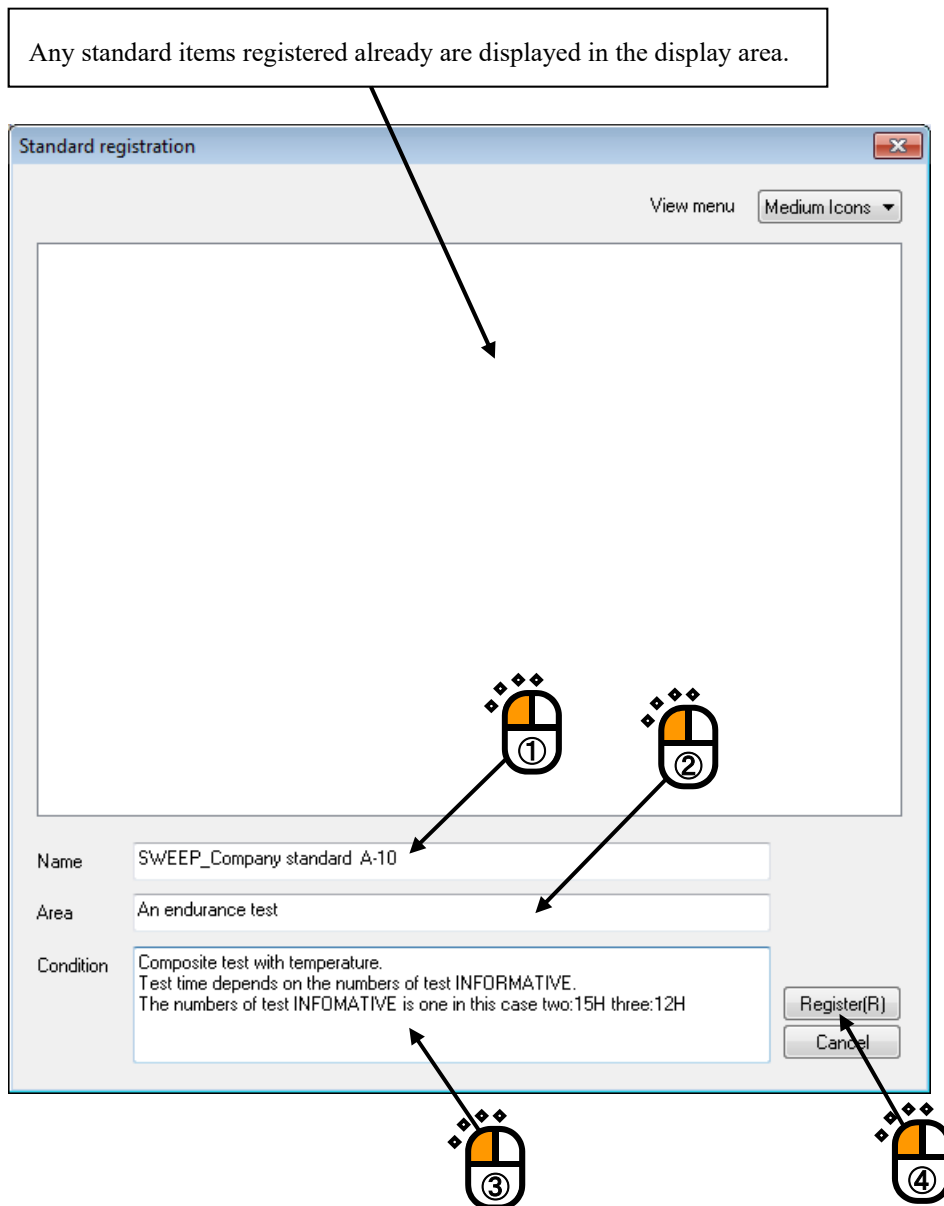

< Step 3 >

When 'Standard' is set to 'Others' in the 'Standards' mode of the Launcher, the registered standard items (standard names) are added to the list.

When any standard name is selected, contents registered through individual applications are displayed in the 'Test Summary' area. The registered test file information is set to the reference maximum values and the test time.

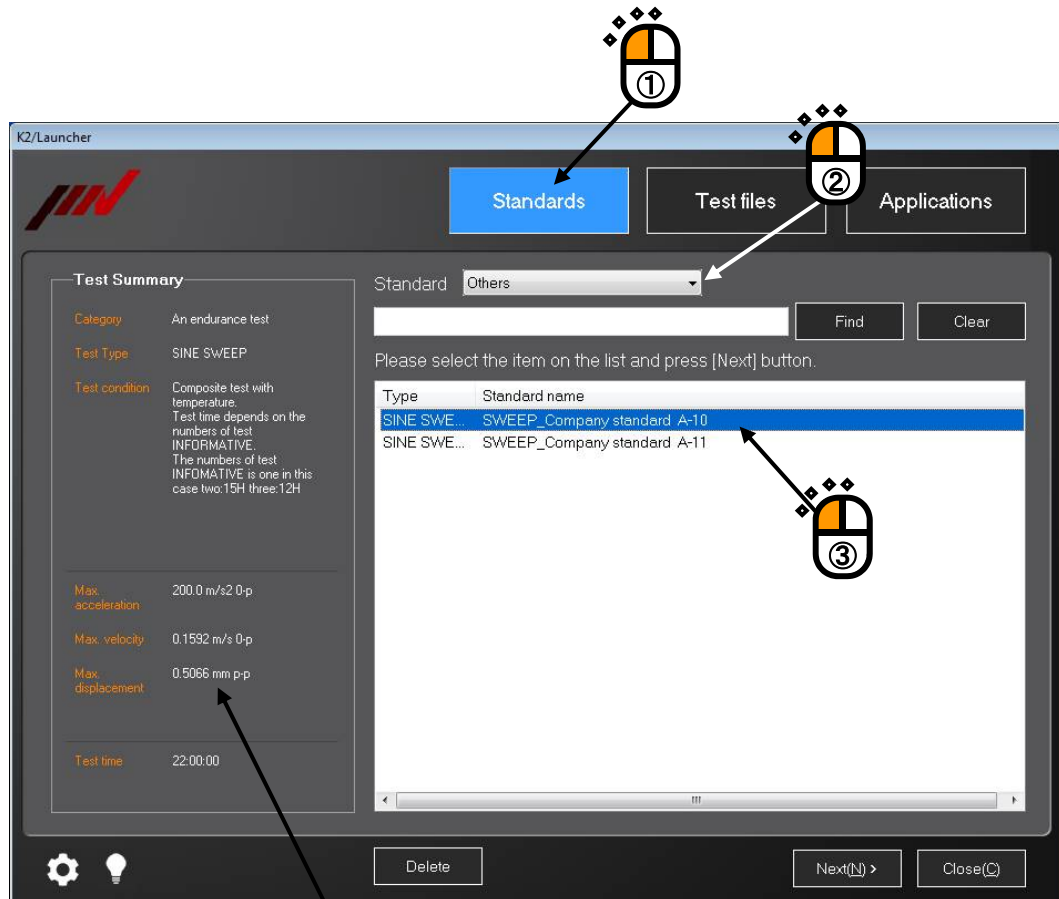

Test information of the selected 'Standard name' is displayed.

### 7.3.1.2 Deletion of Registered Standards

Registered standard items can be deleted through the Launcher.

Note) Standard items to be installed in advance cannot be deleted.

< Procedures >

< Step 1 >

Set 'Standard' to 'Others' in the 'Standards' mode of the Launcher.

Select the standard name to be deleted, and press the button of [Delete].

Even after any standard item is deleted, original test file registered as a standard will not be deleted.

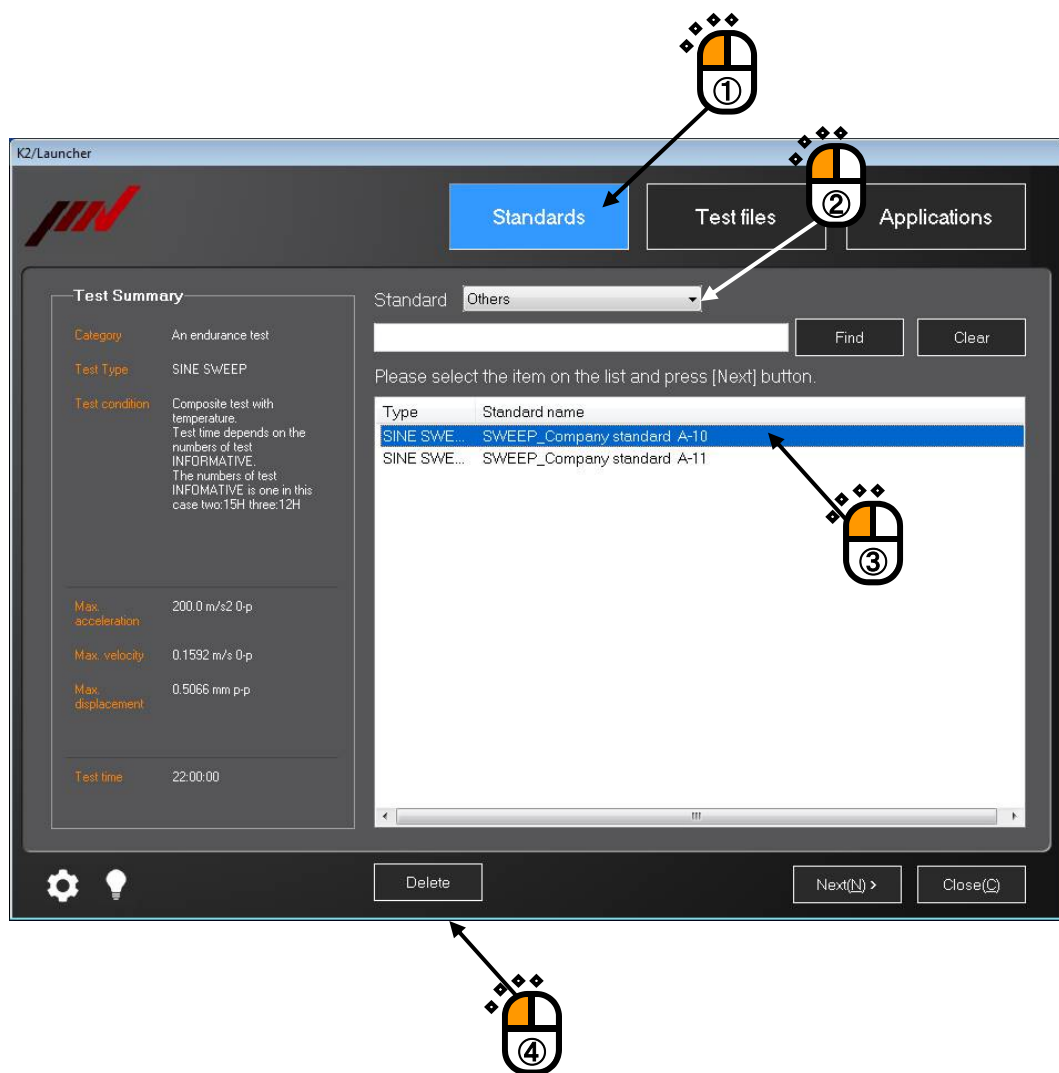

## 7.3.2 Supplementary Explanation of Standards Mode

### 7.3.2.1 Contents Displayed on Screen

Standards installed in advance and 'Other' standards are displayed. 'Others' are the standard items registered by users. When 'All' is selected, all the standard items are displayed.

The screenshot shows the K2/Launcher software interface. At the top, there are three buttons: 'Standards' (highlighted in blue), 'Test files', and 'Applications'. Below these is a 'Test Summary' panel on the left, which displays details for a selected standard: Category (Automobile), Test Type (SINE SWEEP), Test condition ([Use Conditions] Commercial Car Engine or Gearbox), [Sweep rate] 0.5 oct/min, [Direction] Each direction, Max. acceleration 120.0 m/s<sup>2</sup> 0-p, Max. velocity 0.2938 m/s 0-p, Max. displacement 1.4438 mm p-p, and Test time 94:00:00. To the right of the summary is a search area with a 'Standard' dropdown menu set to 'All', a search input field, and 'Find' and 'Clear' buttons. Below the search area is a list of standard items with columns for 'Type' and 'Standard name'. The first item is highlighted in blue: SINE SWEEP JASO D 014-3:2014 Auto Parts Functional Test Commercial Car Test 9 Engine/. Other items include RANDOM, SOR, and SINE SWEEP with various test names. At the bottom of the list area, there is a 'Next(N) >' button and a 'Close(C)' button. A gear icon and a lightbulb icon are visible at the bottom left of the interface.

Test information of selected standard items are displayed.

Standard items registered to the selected standards (test types and standard names) are displayed. Items in gray characters are the items of test types without license. Even if standard name of the test type without license is selected, the next screen will not appear.

### 7.3.2.2 Finding of Standards

Standards required can be found from the registered standard items by arbitrary keywords.

< Procedures >

< Step 1 >

Select 'Standards' mode, and select any standard to be found.

In this example, 'All' is selected. In this case, all the registered standard items are to be objects of finding.

Enter keywords into the input area, and press the button of [Find].

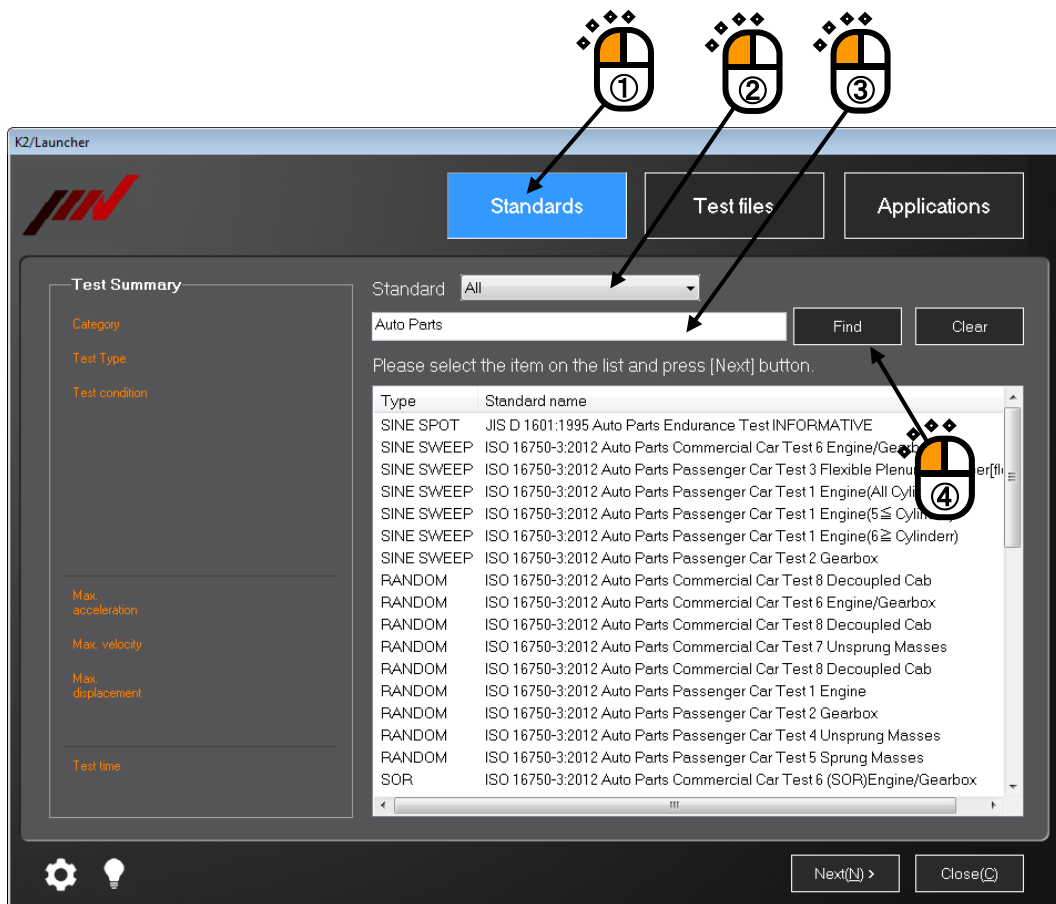

< Step 2 >

Standard items including the keywords entered in the area of 'Standard name, Test summary, type' is displayed in the list.

To release the finding result using keywords, press the button of [Clear].

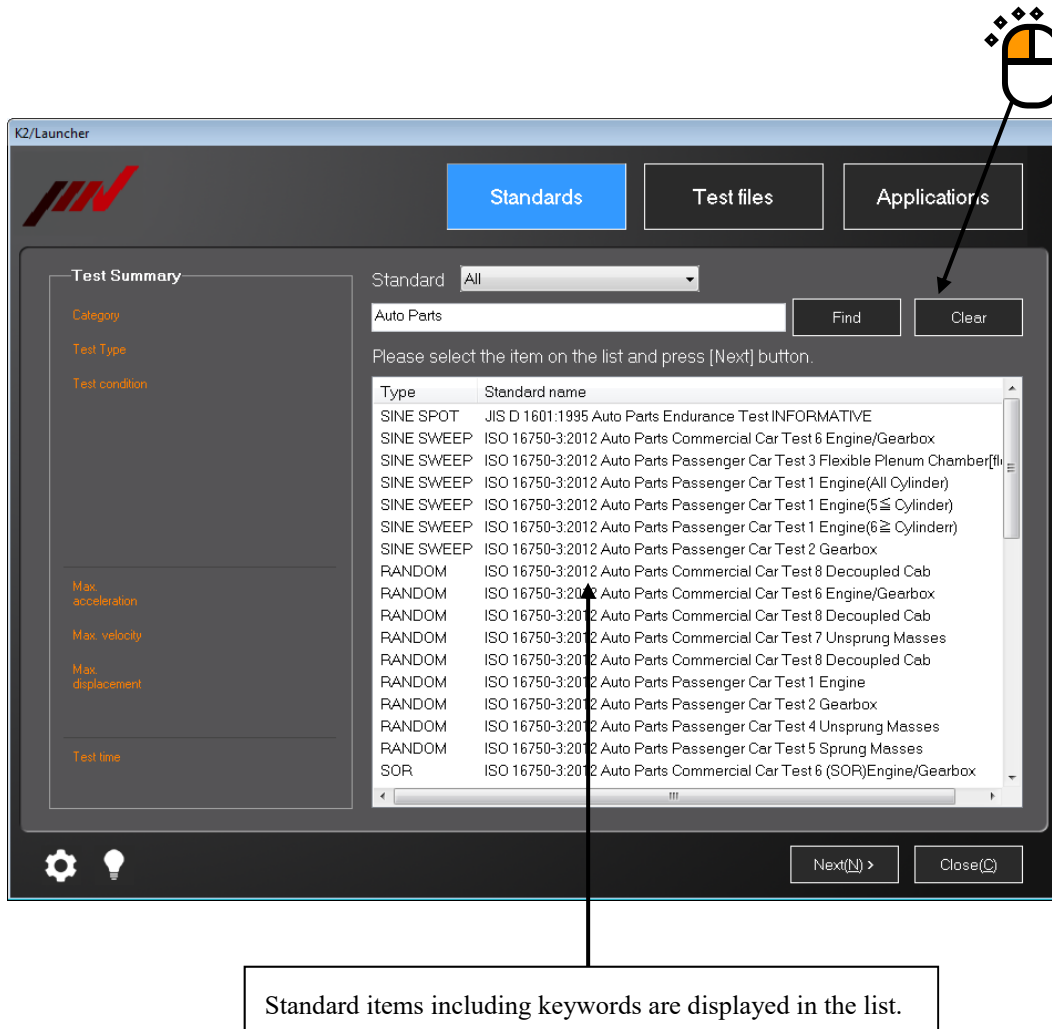

### 7.3.2.3 Test summary Information Registered in Saved Test File

Test summary information is automatically registered in the test file saved in the 'Standards' mode.

Contents to be registered are as shown below.

- Field : Contents of selected standards are taken over.
- Test type : Contents of selected standards are taken over.
- Test condition : Standards and standard names are registered.
- Reference maximum value information : Contents of selected standards are taken over.
- Test time : Defined contents are registered.

When the test file saved in the 'Test files' mode is selected, contents registered here are displayed as the Test summary information.



### 7.3.2.4 Setting of control channel

In the 'Standards' mode, the control channel can be selected from the input channels that are defined in the top information registered in the input environment information.

All defined input channels in the top information except the selected channel as control channel are set to the monitor channel.

**When change of the monitor channel setting is needed, open the test file from applications and change the setting.**

#### 7.3.2.4.1 Use the original sensitivity of input environment information

Check the check box of "Select input environment information".

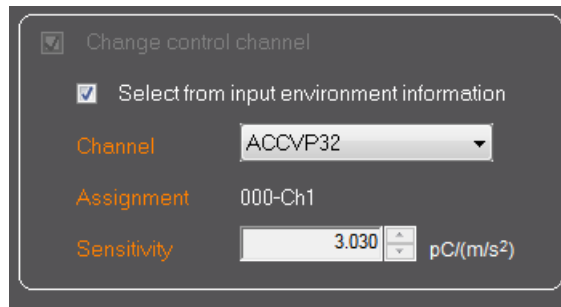

The screenshot shows a dialog box titled "Change control channel" with a checked checkbox. Below it, another checkbox labeled "Select from input environment information" is also checked. The "Channel" dropdown menu is set to "ACCVP32". The "Assignment" field shows "000-Ch1". The "Sensitivity" field is a numeric input set to "3.030" with a unit of "pC/(m/s<sup>2</sup>)".

The first channel of the top information registered in the input environment information is displayed. Select the control channel from the displayed input channel list.

**The sensitivity of the selected input channel can NOT be changed.**

The test file saving screen appears after the button of [Next] is pressed.

#### 7.3.2.4.2 Modify the sensitivity of input environment information

Clear the check box of "Select input environment information".

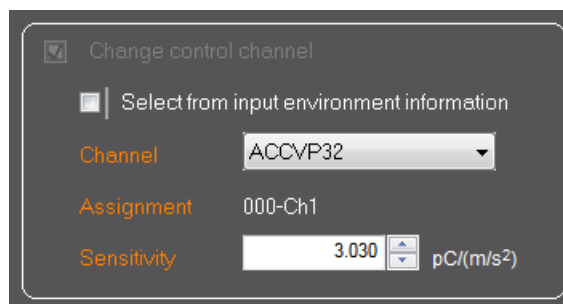

The screenshot shows the same dialog box as above, but the checkbox "Select from input environment information" is now unchecked. The "Channel" dropdown menu remains "ACCVP32", the "Assignment" is "000-Ch1", and the "Sensitivity" is "3.030 pC/(m/s<sup>2</sup>)".

The first channel of the top information registered in the input environment information is displayed. Select the control channel from the displayed input channel list.

**The sensitivity of the selected input channel can be changed.** The sensitivity of the input environment information is not changed by this modification.

The test file saving screen appears after the button of [Next] is pressed.

## 7.3.3 Supplementary Explanation of Test Files Mode

### 7.3.3.1 Folder

#### 7.3.3.1.1 Contents Displayed on Screen

When 'Folder' is selected in the 'Test files' mode, the list of test files in the selected folder is displayed.



The selected folder is displayed.

Test summary information of the selected test file is displayed. For the test files not created by 'Standards', only test type is displayed.

Test files in the selected test folder are displayed. The displayed test files are of the test types applicable in the 'Test files' mode only. Items in gray characters are the items of test types without license. Even if the test file of the test type without license is selected, the next screen will not appear.

Type	File name	Modified
SINE SWEEP	ISO16750-3_2012_Test1_Curve1_20150210	2015/02/10 11:56
SINE SWEEP	SineSweep-torisetu-4.3.5	2015/02/06 10:34
SINE SWEEP	Sweep_ACCmps2_435	2015/02/06 10:36
RANDOM	ISO12045-1_2011_Part2_20150210	2015/02/10 11:47
RANDOM	JISE4031_2013_LT_Cat1A_Longitudinal_20150210	2015/02/10 12:38

[Select Folder] : Folder to be displayed can be selected.

[Delete] : Selected test file can be deleted.

[Favorite] : Selected test file can be registered to 'Favorite'.

### 7.3.3.1.2 Test summary Information Registered to Saved Test File

Test summary information can be registered into the saved test file automatically.  
Contents to be registered are as shown below.

- Field : Contents of selected test file are taken over.
- Test type : Contents of selected test file are taken over.
- Test condition : Contents of selected test file are taken over.
- Reference maximum value information: Contents of selected test file are taken over.
- Test time : Defined contents are registered.

When the test file saved in the 'Test files' mode, contents registered here are displayed as the Test summary information.

### 7.3.3.2 History

#### 7.3.3.2.1 Contents Displayed on Screen

When 'History' is selected in 'Test files' mode, the list of test files executed in the past is displayed.

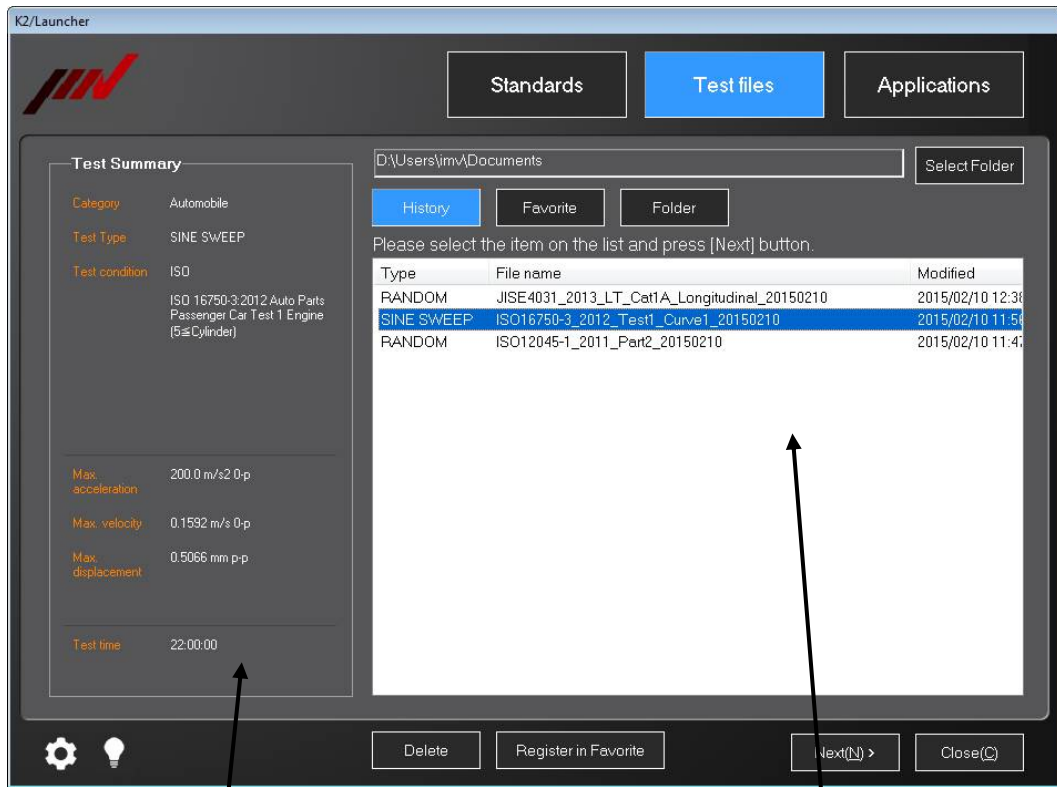

Test summary information of the selected test file is displayed. If the test file is not created from 'Standards', only test type is displayed.

Test files executed in 'Standards' mode and 'Test files' mode are to be objective.

- [Delete] : Selected test file can be deleted. Test file itself cannot be deleted.
- [Favorite] : Selected test file can be registered to 'Favorite'.

#### 7.3.3.2.2 Test summary Information Registered to Saved Test File

Similar to 'Folder'.

Refer to "Section 7.3.3.1.2".

### 7.3.3.3 Favorite

#### 7.3.3.3.1 Contents Displayed on Screen

Select 'Favorite' in the 'Test files' mode.

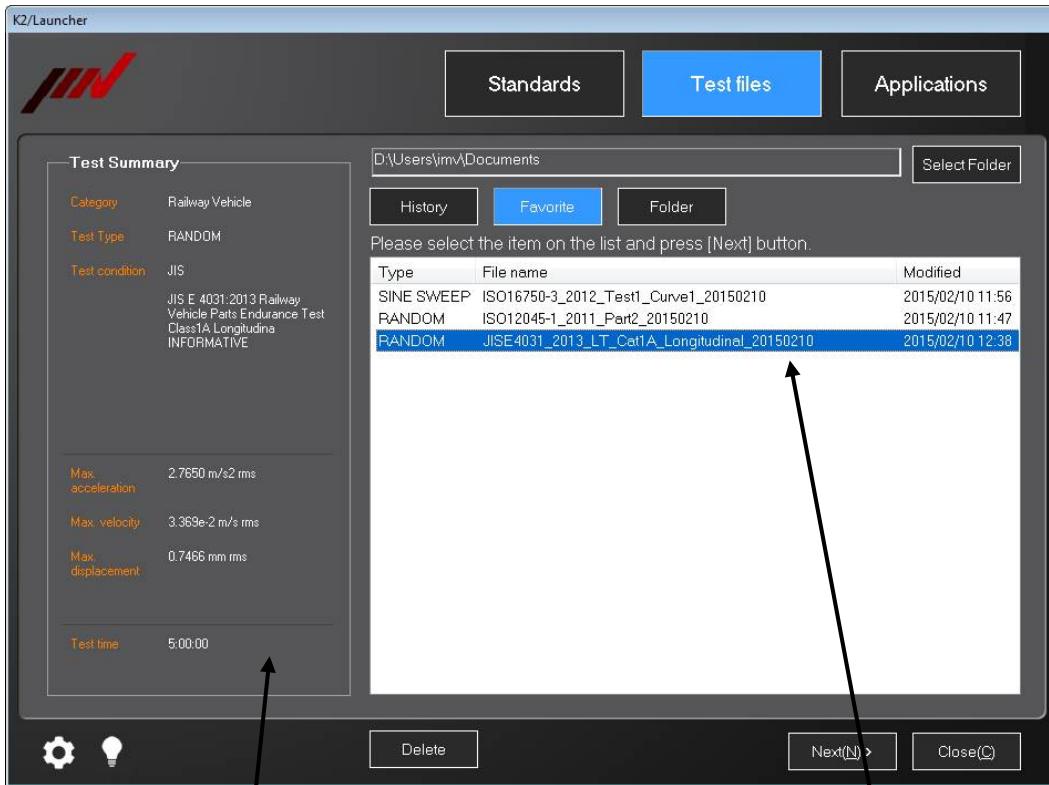

Test summary information of the selected test file is displayed. For the test file not created from 'Standards', only test type is displayed.

The list of test file registered in the 'Favorite' is displayed.

[Delete] : Selected test file can be deleted. Test file itself cannot be deleted.

#### 7.3.3.3.2 Test summary Information Registered to Saved Test File

Similar to 'Folder'. Refer to "Section 7.3.3.1.2".

### 7.3.3.4 Setting of control channel

In the 'Test files' mode, there are the following three options for control channel setting.

- 1) Use the original setting of the selected test file without modification
- 2) Modify the setting of the selected test file
- 3) Use the top information of the input environment information list

#### 7.3.3.4.1 Use the original setting of the selected test file without modification

Clear the check box of "Change control channel"

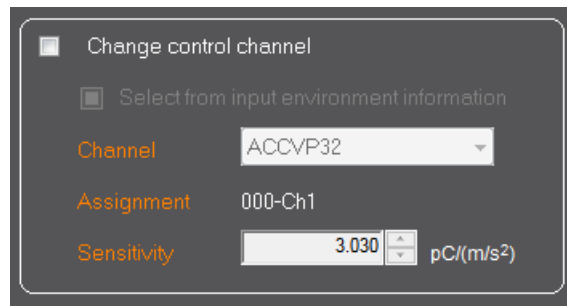

The screenshot shows a dark-themed control panel. At the top, there is a checkbox labeled "Change control channel" which is currently unchecked. Below it is another checkbox labeled "Select from input environment information" which is checked. Underneath, there are three rows of settings: "Channel" with a dropdown menu showing "ACCVP32", "Assignment" with the text "000-Ch1", and "Sensitivity" with a numeric input field containing "3.030" and a unit label "pC/(m/s<sup>2</sup>)".

The test file saving screen doesn't appear after the button of [Next] is pressed.

The selected test file is executed without modification.

#### 7.3.3.4.2 Modify the setting of the selected test file

Check the check box of "Change control channel" and clear the check box of "Select input environment information".

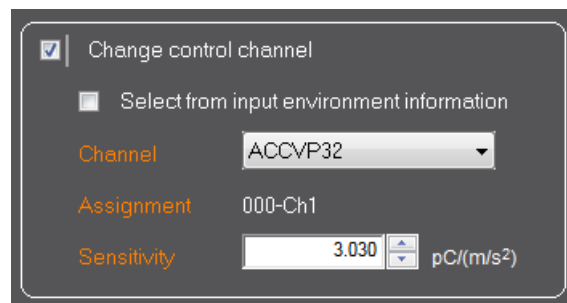

The screenshot shows the same control panel as in the previous image. The "Change control channel" checkbox is now checked, and the "Select from input environment information" checkbox is now unchecked. The other settings (Channel: ACCVP32, Assignment: 000-Ch1, Sensitivity: 3.030 pC/(m/s<sup>2</sup>)) remain the same.

The first channel of the defined input channels in the selected test file is displayed.

Select the control channel from the displayed input channel list.

**The sensitivity of the selected input channel can be changed.**

The test file saving screen appears after the button of [Next] is pressed.

All displayed input channels in the list except the selected channel are set to the monitor channel.

**When change of the monitor channel setting is needed, open the test file from applications and change the setting.**

### 7.3.3.4.3 Use the top information of the input environment information list

Check the check box of "Change control channel" and check the check box of "Select input environment information".

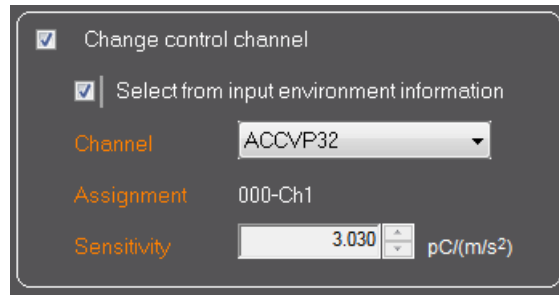

The screenshot shows a dark-themed control panel with the following elements:

- Two checked checkboxes: "Change control channel" and "Select from input environment information".
- A "Channel" dropdown menu set to "ACCVP32".
- An "Assignment" field set to "000-Ch1".
- A "Sensitivity" field set to "3.030" with a unit of "pC/(m/s<sup>2</sup>)".

The first channel of the top information registered in the input environment information is displayed.

Select the control channel from the displayed input channel list.

**The sensitivity of the selected input channel can NOT be changed.** T

The test file saving screen appears after the button of [Next] is pressed.

All defined input channels in the top information except the selected channel as control channel are set to the monitor channel.

**When change of the monitor channel setting is needed, open the test file from applications and change the setting.**

### 7.3.4 Quick Help

If you do not know how to use the Launcher, you can always use the Quick Help to be displayed. When the Quick Help appears, the definition order is displayed in numerics.

< Procedures >

< Step 1 >

Press the button of  in the lower left part of the Launcher screen.

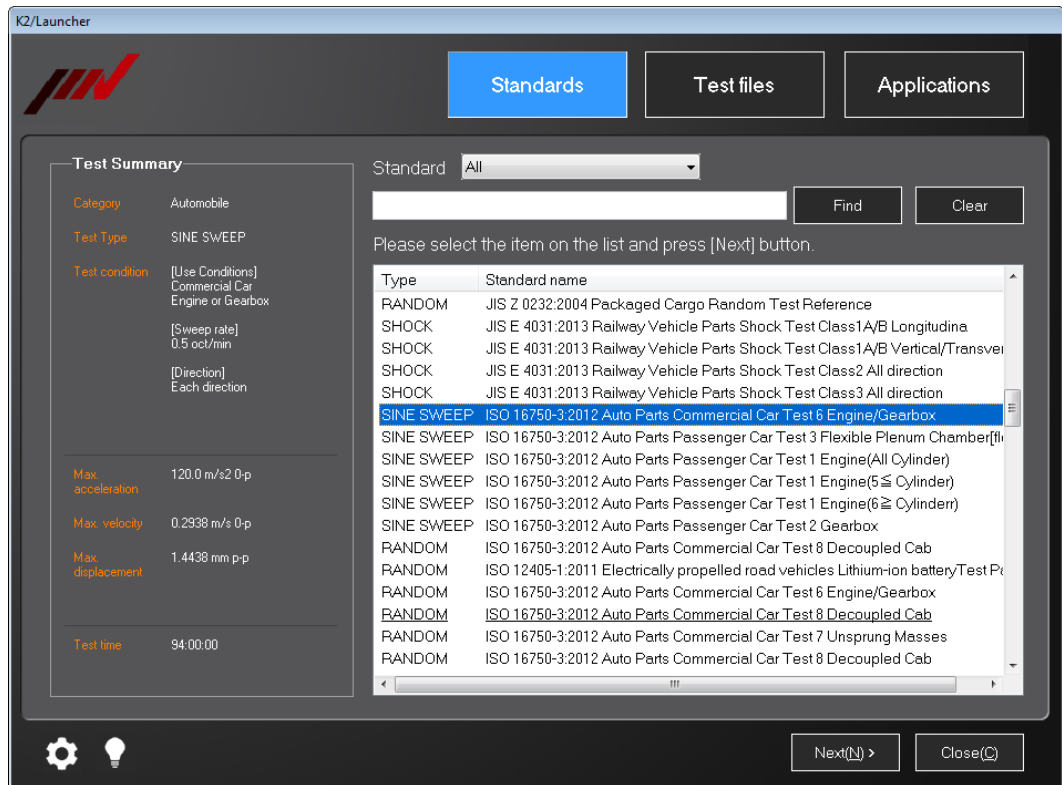



< Step 2 >

Quick Help appropriate for the screen appears.

In this example, the Quick Help means as shown below.

First, select mode.

Second, select standard.

Third, select list.

Fourth, press the button of [Next].

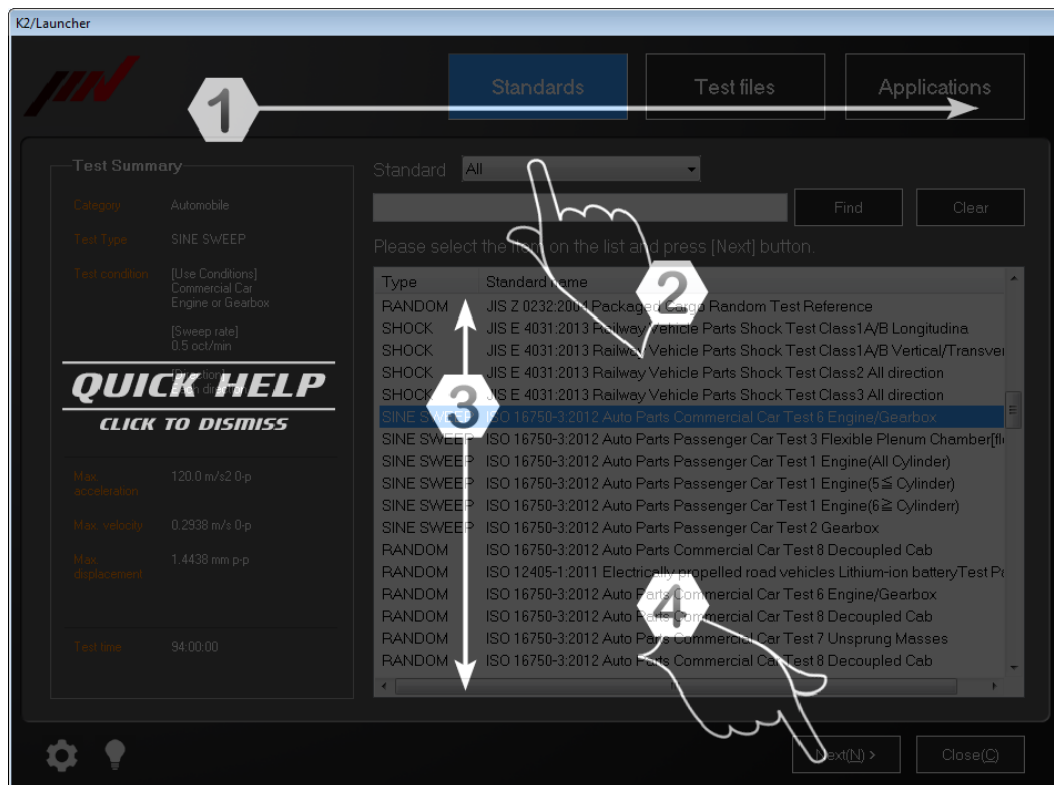

When any area is clicked on the screen, the Quick Help disappears.

Supplementation) If the operation setting is set to 'Display Guide', the Quick Help is displayed automatically whenever the screen is changed.

## 7.3.5 Operating Setting

### 7.3.5.1 Setting Procedures

< Procedures >

< Step 1 >

Press the  button in the lower left part of the top screen of the Launcher.

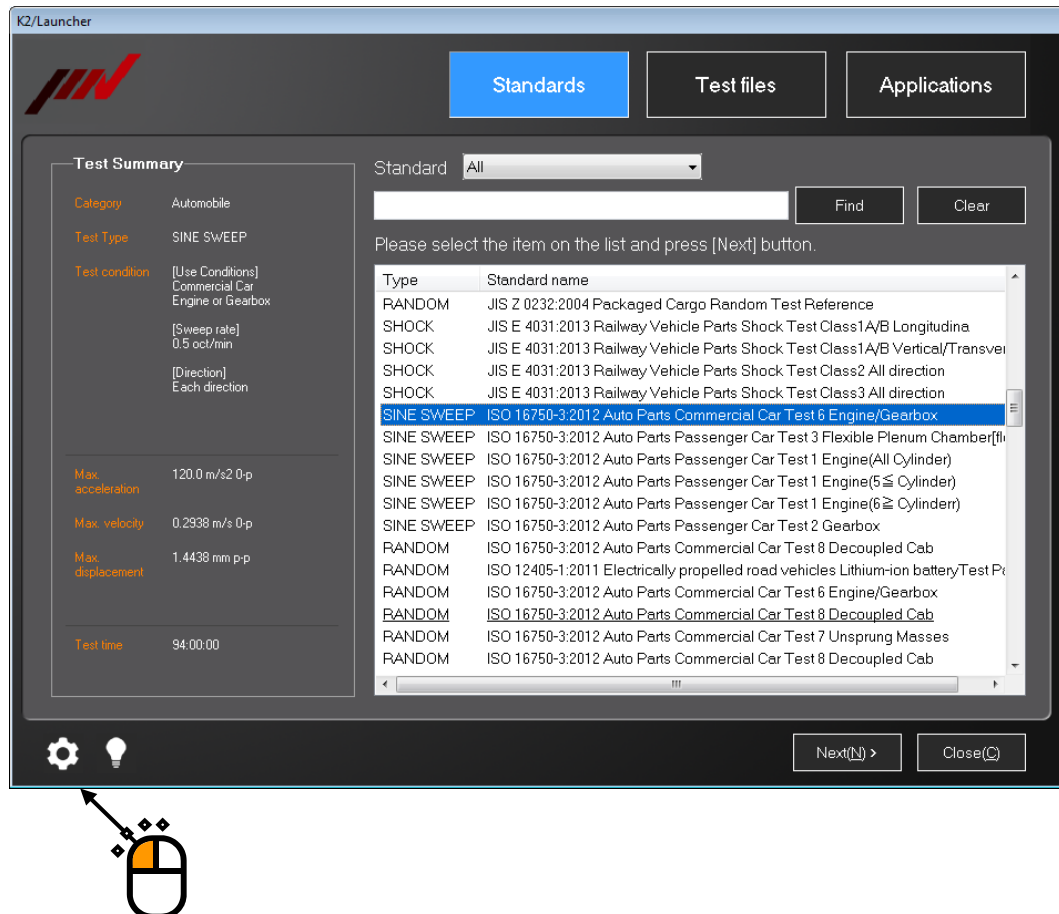

< Step 2 >

Operation setting items appear.

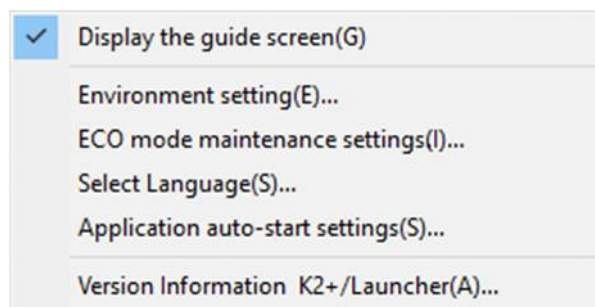

If any item to be set up is selected, it is checked or unchecked, or the setting screen appears according to the items.

### 7.3.5.2 Setting Item

- (1) Display the guide screen  
If it is checked, the Quick Help is displayed automatically whenever the screen is changed.
  
- (2) Environment setting  
Information relative to the I/O unit, excitation system rating, and the specifications of sensors generally used can be set up.  
For details, refer to “Chapter 3 Setting of K2”.
  
- (3) ECO mode maintenance settings (Optional)  
The settings relative to ECO option can be set up.  
For details, refer to “5.4 Settings for ECO-option” in Chapter 5.
  
- (4) Select Language (Optional)  
This function is optional.  
The language to be displayed through the K2 application can be changed.  
For details, refer to “4.6 Selecting Languages” in Chapter 4.
  
- (5) Application auto-start settings  
When the PC is booted, resident applications are started automatically.  
This auto-start can be enabled / disabled.  
For details, refer to “7.3.6 Application auto-start settings” in this chapter.
  
- (6) Version Information  
Application version information appears.

### 7.3.6 Application auto-start settings

On K2 system, when the PC is booted, resident applications are started automatically as bellow;

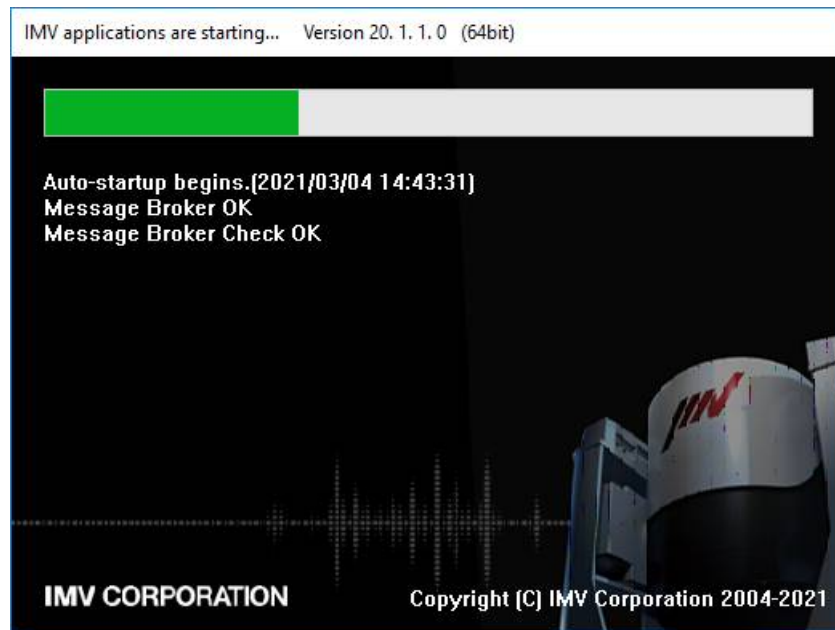

This auto-start can be enabled / disabled.

**NOTE) If the setting items described here is changed incorrectly, the system would not work correctly. Please do not change the settings from those set at the shipping from the factory.**

<Procedures>

<Step 1>

Press the  button in the lower left part of the top screen of the Launcher and select “Application auto-start settings” menu.

<Step 2>

The warning message appears. Press [Yes] button to close this message.

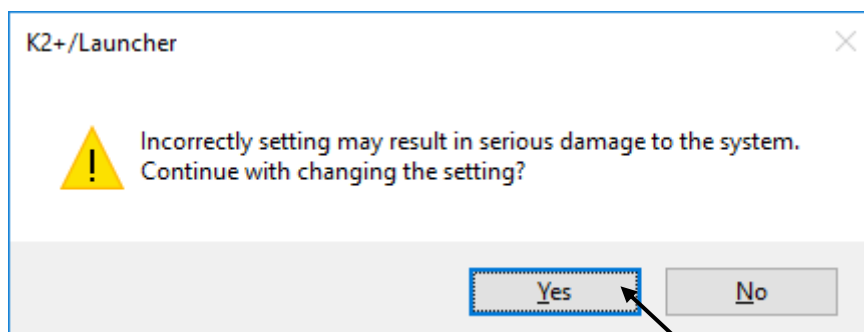

< Step 3 >

To enable auto-start check the application and to disable uncheck the application.  
Press [OK] button when changes are completed.

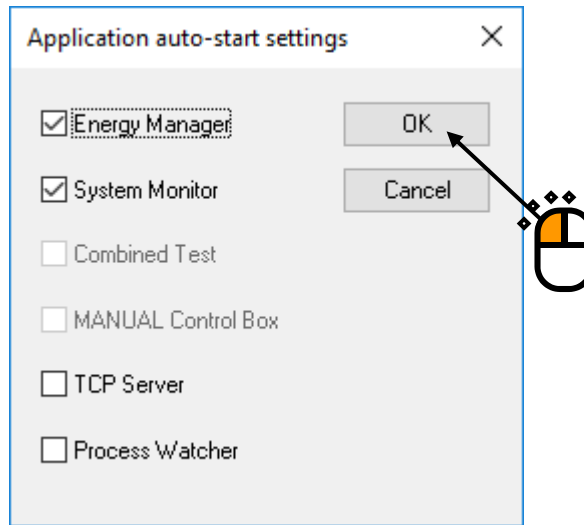

< Step 4 >

Finally, the message appears. Press [OK] button to close this message.  
Since the next booting of PC, this change will be available.

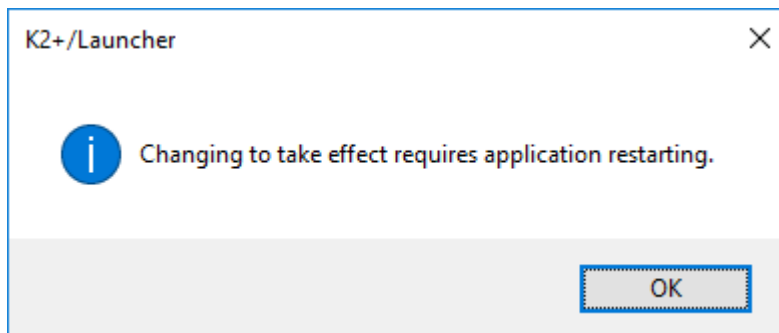

# Chapter 8 Condition Check

## 8.1 Outline

The “Condition Check” application (hereinafter referred to as “this application”) is used for the following purposes:

- (1) Diagnoses of dynamic characteristics and aged deterioration of an excitation system and a sensor
- (2) Inspection of input sensitivity of the vibration controller (K2+), and simplified diagnoses of an excitation system and a sensor

Mainly, this application provides the following two functions to execute these diagnoses:

(A) Constant voltage characteristics

This function is used for diagnoses of dynamic characteristics and aged deterioration of an excitation system.

In connection with the excitation system, this application outputs a sine wave of a constant drive level while conducting frequency sweep, to measure frequency characteristics.

This application enables diagnoses of the shaker, amplifier and sensor based on input response levels.

This application also enables diagnosis of aged deterioration of the excitation system by comparing test data with those in the past through continuous measurements.

(B) Input channel characteristics

This function is used for input sensitivity inspection of the vibration controller (K2+) and simplified diagnoses of an excitation system and a sensor.

This application outputs a sine wave of a constant drive level at a fixed frequency, to measure response levels.

With an input channel directly connected to an output channel, this application enables inspection of K2+ input sensitivity.

In connection with the excitation system, this application also enables simplified diagnosis of the excitation system.

**CAUTION) When you execute this application with a product or jig mounted on the shaker, use caution. The product or jig may suffer damage depending on output level and frequency.**

At startup of the Condition Check application, the following window opens.  
 All input channels of the I/O unit are displayed in “Operation status”.  
 To close the program, press the close (x) button.

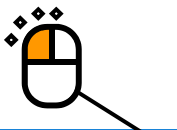

K2+/CONDITION CHECK
- □ ×

**Input Channel Characteristics**    **Constant Voltage Characteristics**     Keeping the current settings:

Frequency:  Hz <=>  Hz

Output level:  mV<sub>0-p</sub>

Output channel:

Data storage destination: [C:\K2Data\VMV\\_Data](#)

[Play the guide video](#)    [Send e-mail](#)

**Sensitivity**

All channels

Channel name	Sensitivity	Type
<input checked="" type="checkbox"/> 000-Ch1	3.0 pC/(m/s <sup>2</sup> )	1mV/pC
<input checked="" type="checkbox"/> 000-Ch2	3.0 pC/(m/s <sup>2</sup> )	1mV/pC
<input checked="" type="checkbox"/> 000-Ch3	3.0 pC/(m/s <sup>2</sup> )	1mV/pC
<input checked="" type="checkbox"/> 000-Ch4	3.0 pC/(m/s <sup>2</sup> )	1mV/pC
<input checked="" type="checkbox"/> 001-Ch1	3.0 pC/(m/s <sup>2</sup> )	1mV/pC
<input checked="" type="checkbox"/> 001-Ch2	3.0 pC/(m/s <sup>2</sup> )	1mV/pC
<input checked="" type="checkbox"/> 001-Ch3	3.0 pC/(m/s <sup>2</sup> )	1mV/pC
<input checked="" type="checkbox"/> 001-Ch4	3.0 pC/(m/s <sup>2</sup> )	1mV/pC

Input unit:    

Charge type:

**NOTE: Set the sensitivity of the used sensor correctly.**

**Operation status**       

Status

Frequency	Acceleration (m/s <sup>2</sup> 0-p)	Velocity (m/s 0-p)	Displacement (mm 0-p)
000-Ch1			
000-Ch2			
000-Ch3			
000-Ch4			
001-Ch1			
001-Ch2			
001-Ch3			
001-Ch4			
001-Ch5			
001-Ch6			
001-Ch7			
001-Ch8			
002-Ch1			
002-Ch2			
002-Ch3			
002-Ch4			
002-Ch5			
002-Ch6			
002-Ch7			
002-Ch8			

## 8.2 Examples of operations

### 8.2.1 Constant voltage characteristics measurement

<Operating procedure>

This procedure is intended for diagnoses of dynamic characteristics and aged deterioration of the exciting system and sensor.

For details, refer to the guide video.

For the procedure to play the guide video, refer to “8.2.5 Supplementary functions”.

<Step 1>

Connect each device, as shown below.

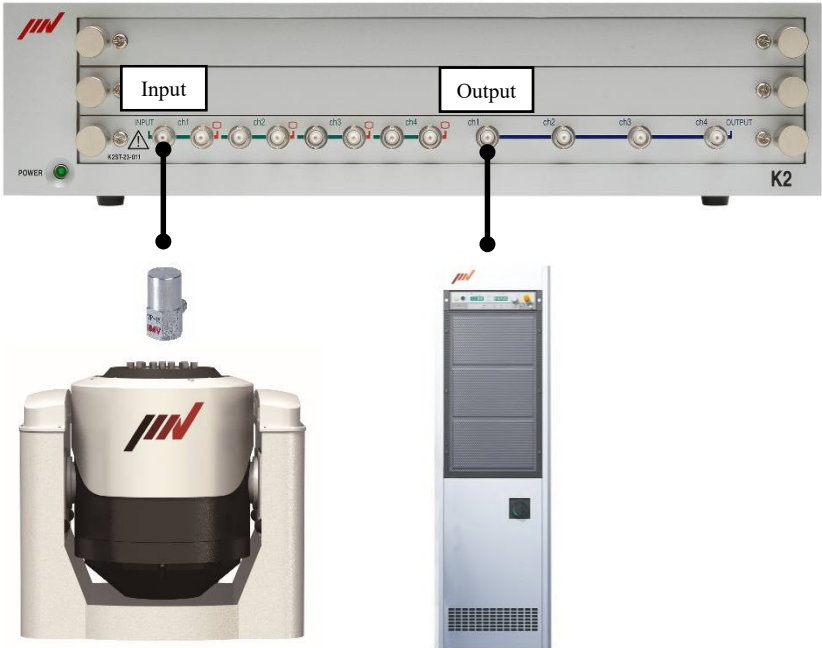

<Step 2>

Select “Constant Voltage Characteristics”.

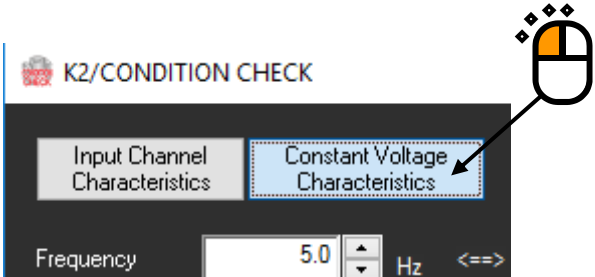



<Step 3>

Specify an input sensitivity.

Select a channel to which a sensor is connected, and specify an input sensitivity.

(The type of sensor applicable to this inspection is acceleration sensor only.)

If you press the “Refer Input Environment Information” button and select input environment information, you can refer to an existing sensitivity setting.

If you uncheck the checkbox in front of a channel name, the relevant channel can be set to be “unused” channel.

Checking the checkbox for “All channels” enables all channels to be changed to be “used” or “unused” at once.

The first channel in used status is the control channel. (In this example, “000-Ch1” is the control channel.)

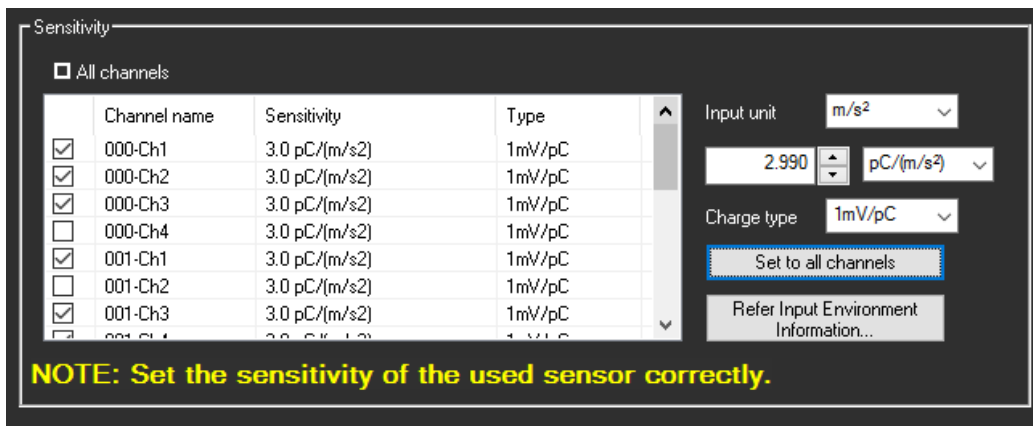

<Step 4>

Specify frequency range and level of a sine wave, and an output channel to be used.

After completion of the above settings, press the start button.

**CAUTION) The frequency range and level vary depending on the excitation system being connected. When a product or jig is mounted on the excitation system, the product or jig may suffer damage depending on output level and frequency.**

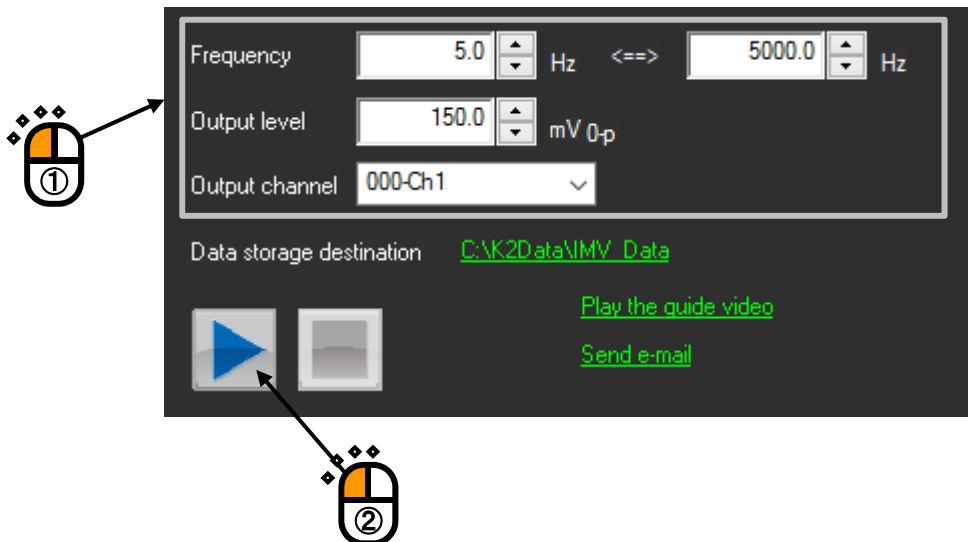

<Step 5>

Current measured values are displayed in “Operation status”.

“Monitor” graph or “Distortion” graph can be also displayed.

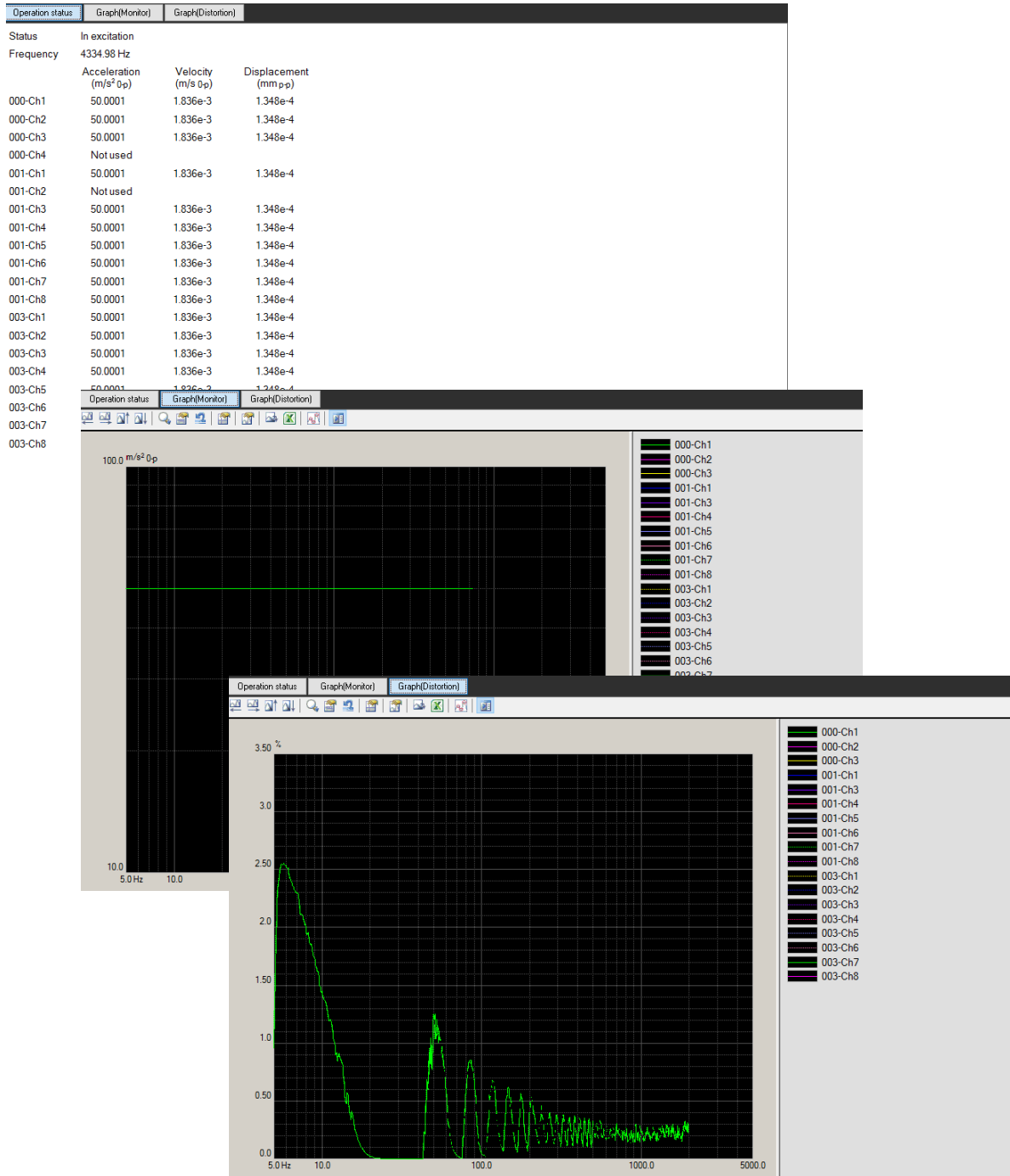

<Step 6>

After completion of the test, save the data.

Specify a file name, and press the [Save] button.

(As the default setting, “year/month/day - hour/minute/second” is specified as file name.)

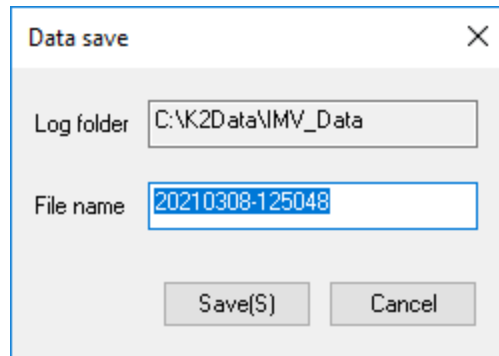

You can open a folder to save the data, by clicking on the link of “Destination folder”.

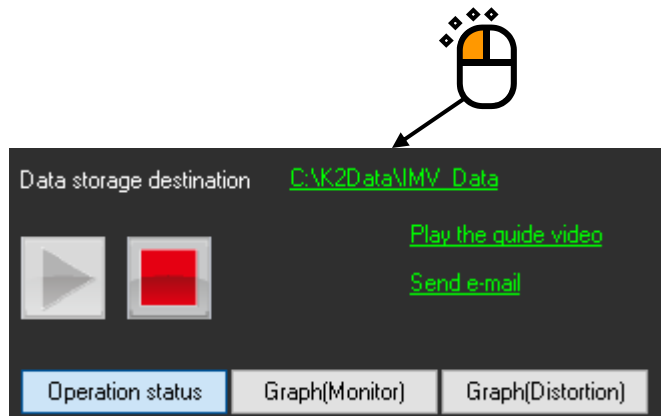

<Step 7>

After the test is completed, you can compare the response data by dragging and dropping an existing data file.

Data subject to view is those for the control channel only.

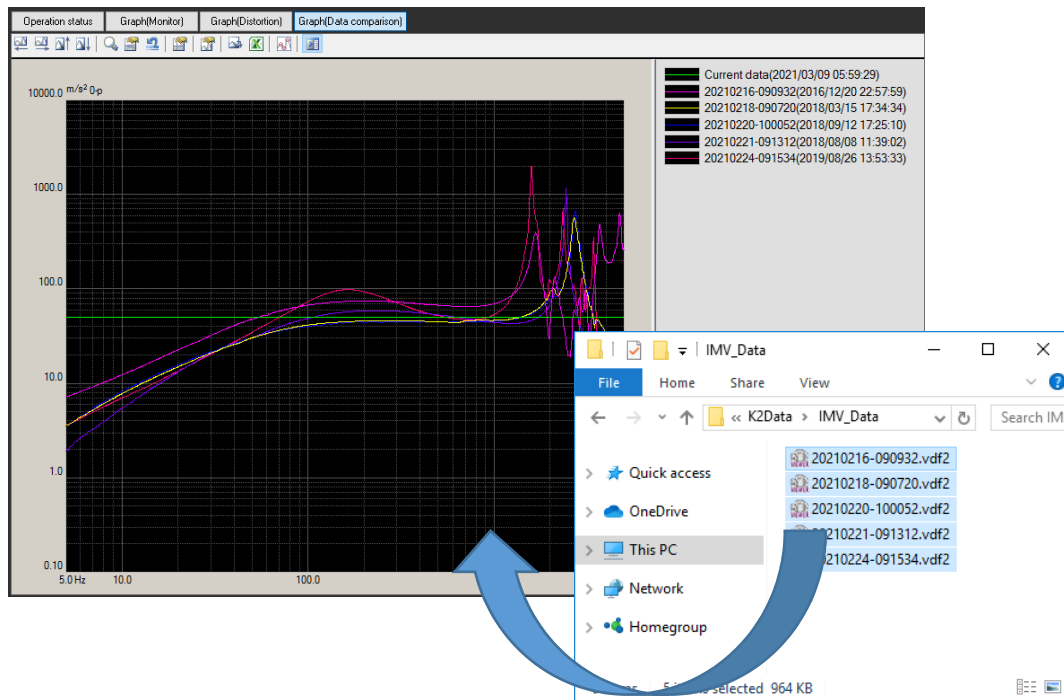

<Step 8>

To stop or end the test, press the stop button.

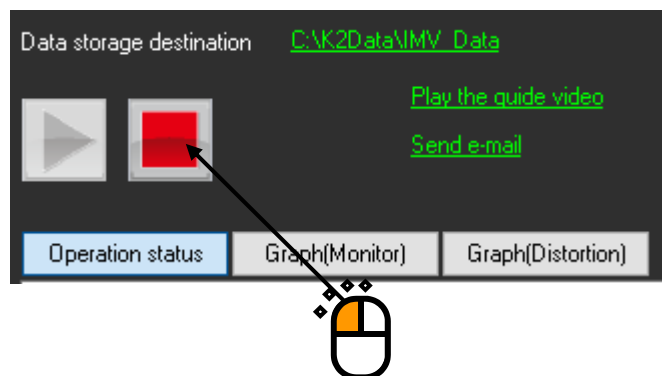

<Step 9>

You can check the following conditions based on the measurement results:

- [1] With any channel, no response is displayed in operation status or monitor graph.  
⇒ It is possible that sensor wire break, connection failure or fault of the sensor has occurred.
- [2] The peak frequency and graph shape are considerably different from data in the past.  
⇒ It is possible that deterioration of consumable parts or fault of the device has occurred.

## 8.2.2 Voltage input sensitivity inspection

<Operating procedure>

This procedure is intended for inspection of K2+ voltage input sensitivity.

<Step 1>

Connect the input channel and output channel subject to calibration via the BNC cable, as shown below.

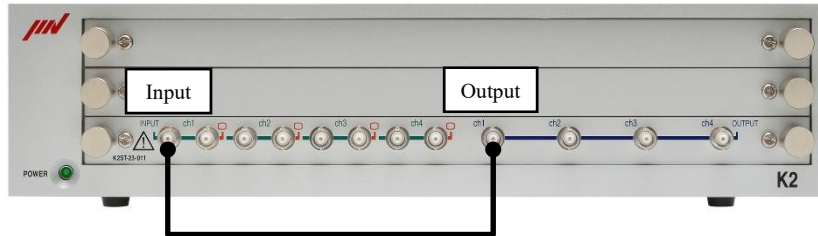

<Step 2>

Select “Input Channel Characteristics”.

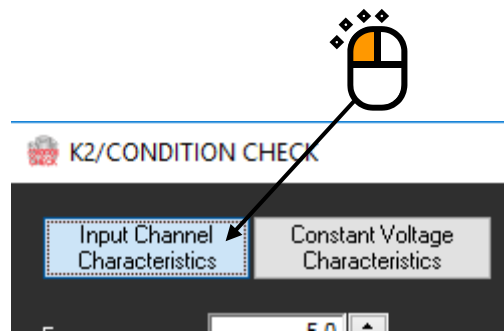

<Step 3>

Specify an input sensitivity.

For “Input type”, select “mV/unit”.

In this example, “5 [mV/m/s<sup>2</sup>]” is specified.

Press the “Set to all channels” button to set the sensitivity to all channels.

The image shows a screenshot of the Sensitivity configuration screen. At the top, there is a checkbox labeled 'All channels' which is checked. Below this is a table with the following columns: Channel name, Sensitivity, and Type. The table contains the following rows:

Channel name	Sensitivity	Type
000-Ch1	3.0 pC/(m/s <sup>2</sup> )	1mV/pC
000-Ch2	3.0 pC/(m/s <sup>2</sup> )	1mV/pC
000-Ch3	3.0 pC/(m/s <sup>2</sup> )	1mV/pC
000-Ch4	3.0 pC/(m/s <sup>2</sup> )	1mV/pC
001-Ch1	3.0 pC/(m/s <sup>2</sup> )	1mV/pC
001-Ch2	3.0 pC/(m/s <sup>2</sup> )	1mV/pC
001-Ch3	3.0 pC/(m/s <sup>2</sup> )	1mV/pC

To the right of the table, there are several controls: 'Input unit' is set to 'm/s<sup>2</sup>', a numerical input field shows '3.0', and a dropdown menu is set to 'pC/(m/s<sup>2</sup>)'. Below these, 'Charge type' is set to '1mV/pC'. At the bottom right, there is a button labeled 'Set to all channels' which is highlighted with a blue dashed border. Below the table, there is a button labeled 'Refer Input Environment Information...'. At the bottom of the screen, there is a yellow note: 'NOTE: Set the sensitivity of the used sensor correctly.'

<Step 4>

Specify frequency and level of a sine wave, and an output channel to be used.

In this example, “80 [Hz]”, “500 [mV]” and “000-Ch1” are specified.

After completion of the above settings, press the start button.

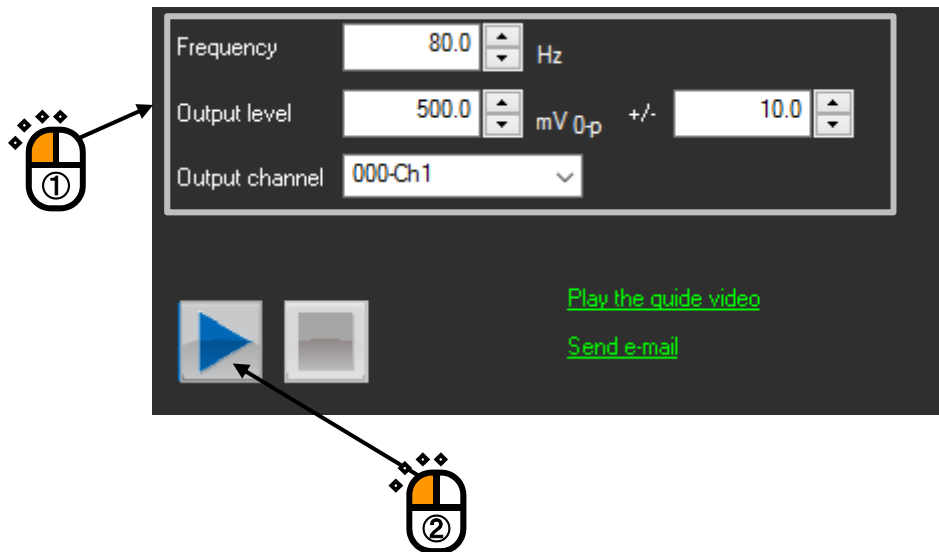

<Step 5>

Measured values are displayed in “Operation status”. In this example, ideal acceleration value is “100 [m/s<sup>2</sup>]”.

To stop the test, press the stop button.

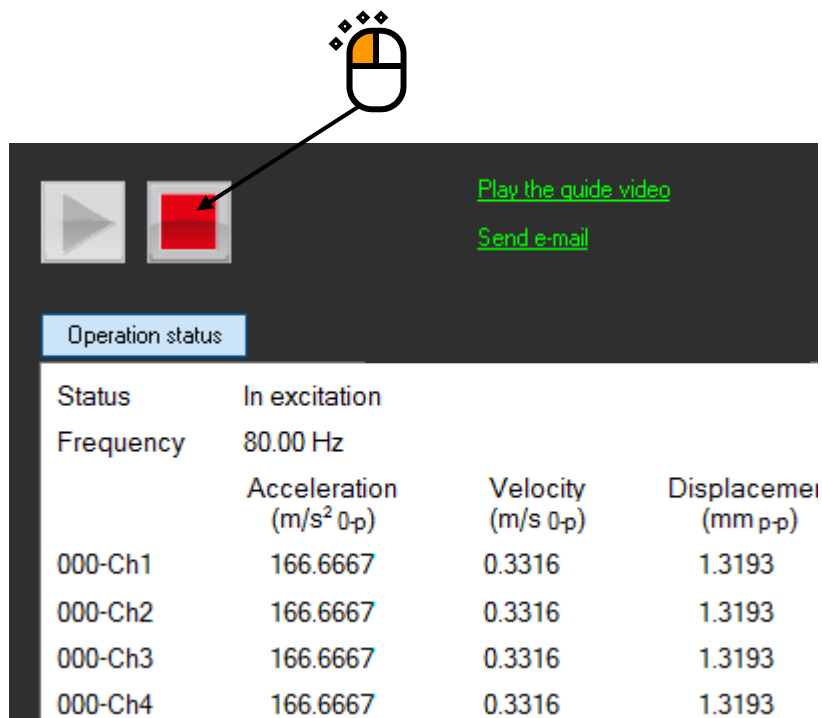

## 8.2.3 Charge input sensitivity inspection

<Operating procedure>

This procedure is intended for inspection of K2+ charge input sensitivity.

<Step 1>

In the connection status same as that for “Voltage input sensitivity inspection”, connect a capacitor to the input channel.

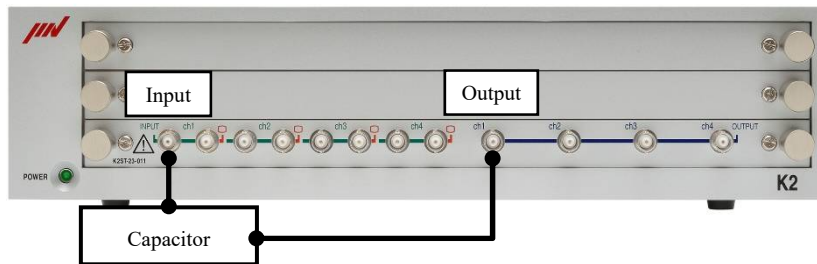

<Step 2>

Select “Input Channel Characteristics”.

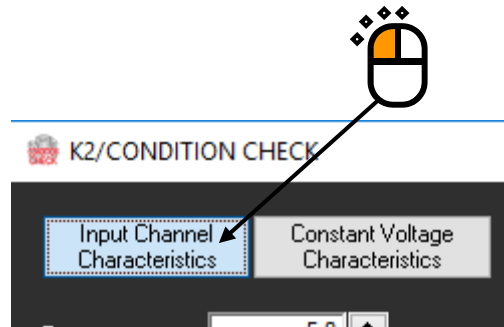

<Step 3>

Specify an input sensitivity.

For “Input type”, select “pC/unit”.

In this example, “5 [pC/m/s<sup>2</sup>]” is specified.

Press the “Set to all channels” button to set the sensitivity to all channels.

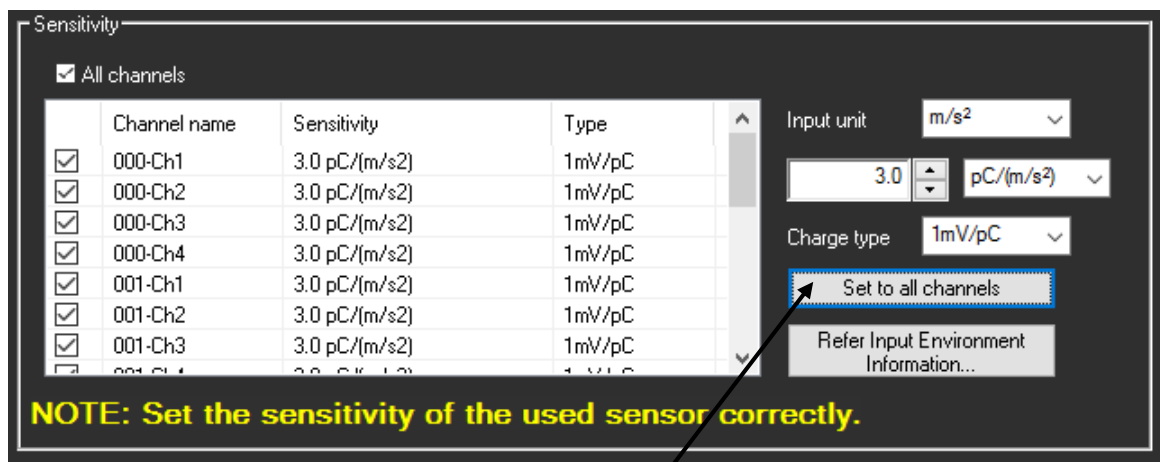

<Step 4>

Specify frequency and level of a sine wave, and an output channel to be used.

In this example, “80 [Hz]”, “500 [mV]” and “000-Ch1” are specified.

After completion of the above settings, press the start button.

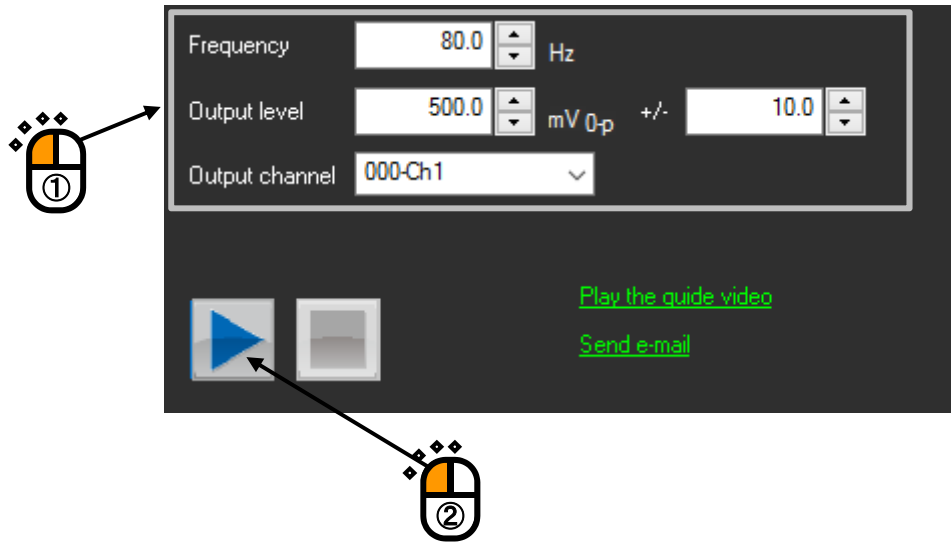

<Step 5>

Measured values are displayed in “Operation status”.

In this example, ideal acceleration value is “ $100 \cdot (C/1000)$  [m/s<sup>2</sup>]”. (C: Capacitance of capacitor [pF])

To stop the test, press the stop button.

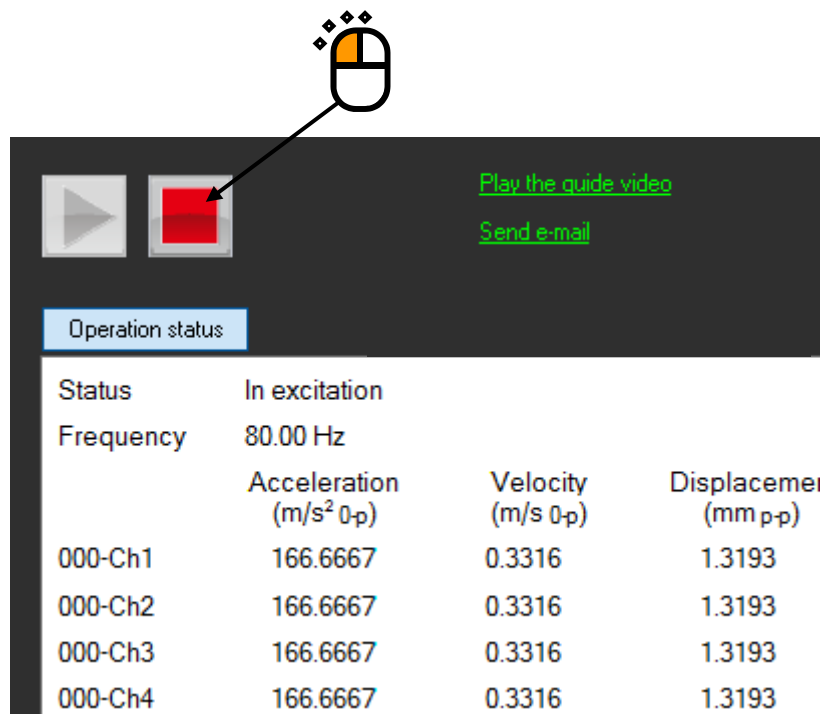



## 8.2.4 Simplified diagnosis of the excitation system

### <Operating procedure>

This procedure is intended for simplified diagnoses of the exciting system.

For details, refer to the guide video.

For the procedure to play the guide video, refer to “8.2.5 Supplementary functions”.

### <Step 1>

Connect each device, as shown below.

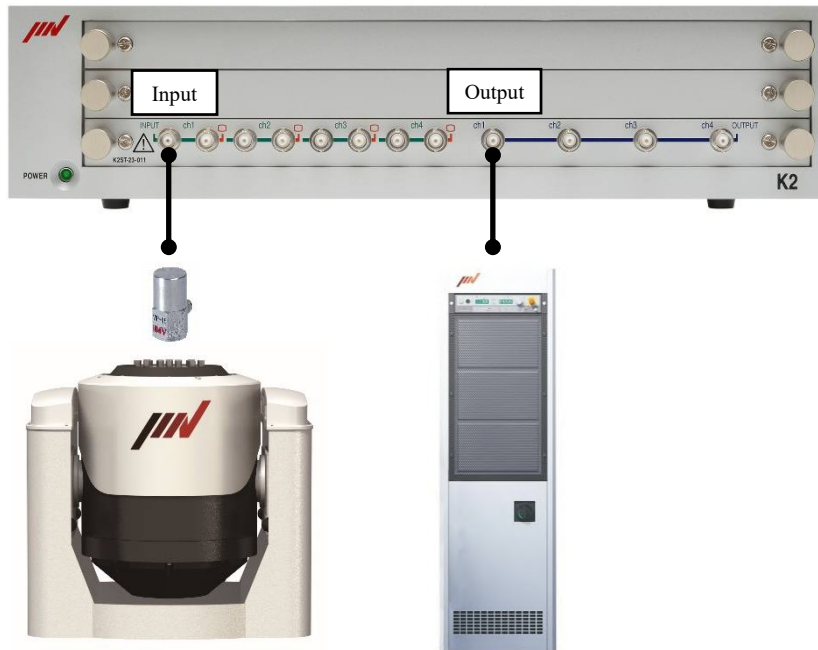

### <Step 2>

Select “Input Channel Characteristics”.

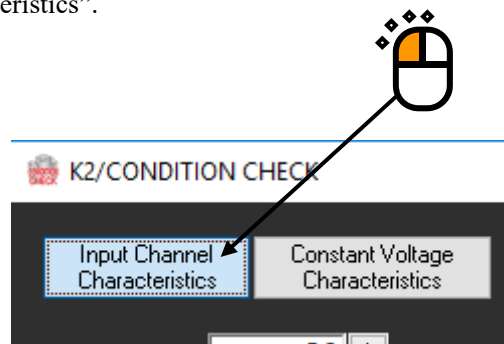

<Step 3>

Specify an input sensitivity.

Select a channel to which a sensor is connected, and specify an input sensitivity.

(The type of sensor applicable to this diagnosis is acceleration sensor only.)

If you press the “Refer Input Environment Information” button and select input environment information, you can refer to an existing sensitivity setting.

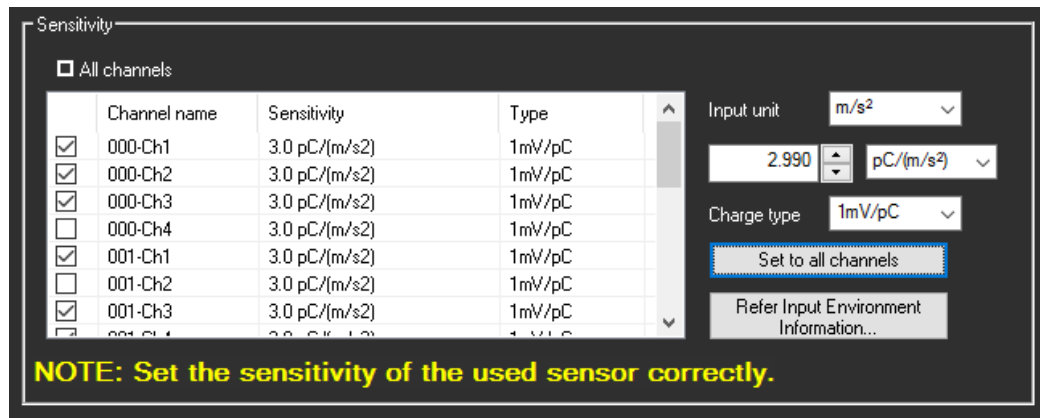

<Step 4>

Specify frequency range and level of a sine wave, and an output channel to be used.

After completion of the above settings, press the start button.

**CAUTION) The frequency range and level vary depending on the excitation system being connected. When a product or jig is mounted on the excitation system, the product or jig may suffer damage depending on output level and frequency.**

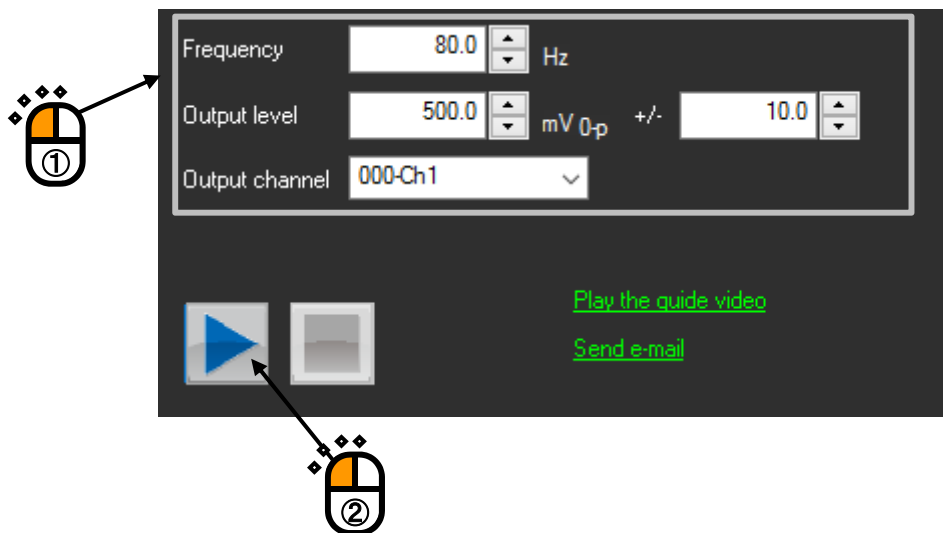

<Step 5>

Measured values are displayed in “Operation status”.

To stop the test, press the stop button.

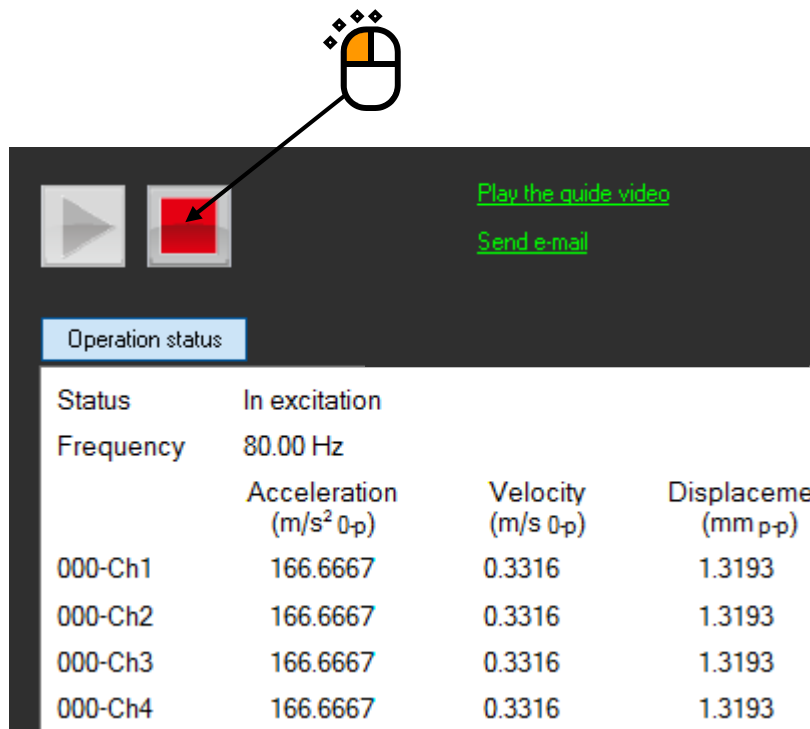

The screenshot shows a software interface with a dark background. At the top left, there are two buttons: a grey play button and a red stop button. A mouse cursor is hovering over the red stop button. To the right of these buttons are two green links: "Play the guide video" and "Send e-mail". Below the buttons is a section titled "Operation status" with a light blue header. Underneath, there is a table with the following data:

Status	In excitation		
Frequency	80.00 Hz		
	Acceleration (m/s <sup>2</sup> 0-p)	Velocity (m/s 0-p)	Displacement (mm p-p)
000-Ch1	166.6667	0.3316	1.3193
000-Ch2	166.6667	0.3316	1.3193
000-Ch3	166.6667	0.3316	1.3193
000-Ch4	166.6667	0.3316	1.3193

General diagnosis flow of the excitation system in this example is as follows:

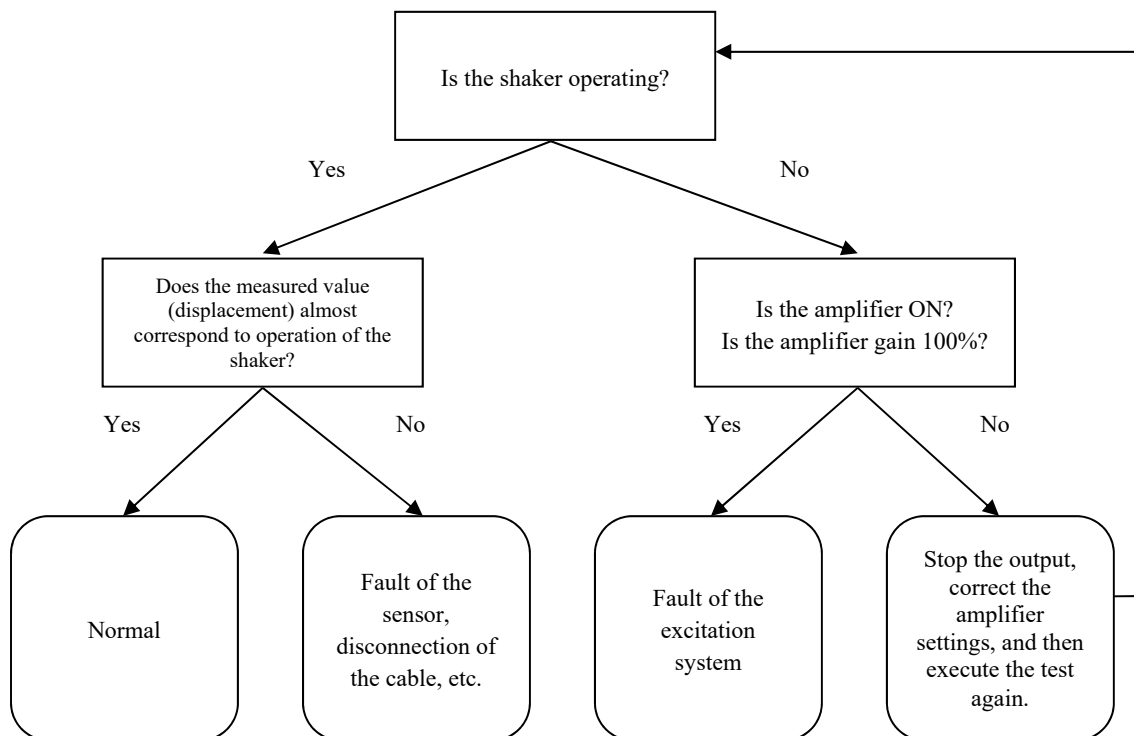

## 8.2.5 Supplementary functions

### (1) Playing the guide video

If you click on the link of “Play the guide video”, the screen to select a video is shown.

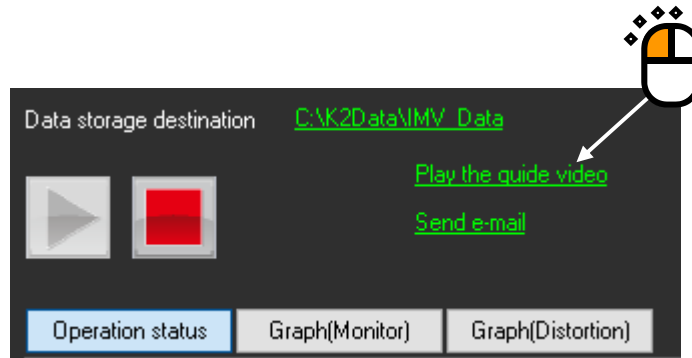

Select a video and press [OK] button.

The videos that can be select are different between s “Input Channel Characteristics” and “Constant Voltage Characteristics”.

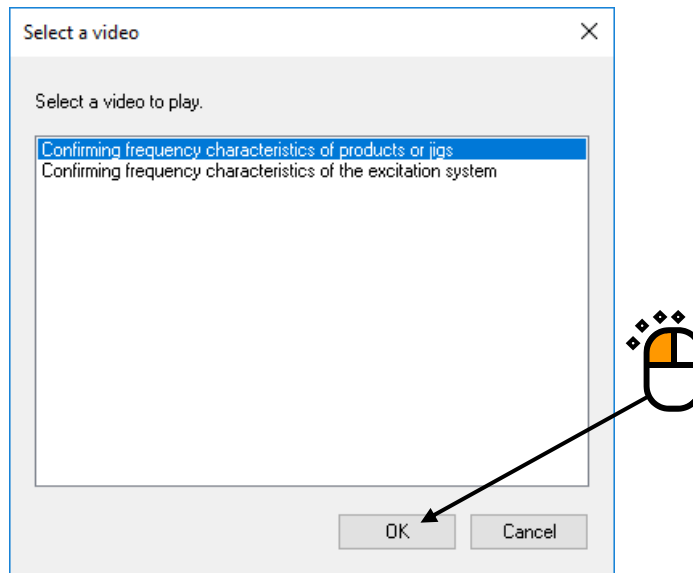

### (2) Sending E-mail

If you click on the link of “Send E-mail”, the provided mailer will start.

This function is useful to contact us for information, when you have a problem or other uncertainty about this application.



# Chapter 9 Intended Use Judgment Function

## 9.1 Outline

The intended use judgment function supports customers' compliance. When an operator attempts to start a test likely to be related to military use, the application software alerts the operator.

Possibility for military use is judged by three levels of "high, middle, and low".

Alert to an operator is performed only when the judgment result is "high".

Since the judgment result of the possibility for military use is also recorded into Test Record of K2, it can be checked by customers themselves. For the checking method, refer to the chapter of Test Record.

## 9.2 Operation Example

### 9.2.1 Procedures

No special operation procedure is required.

Open a test definition file, and click on Ope. start button.

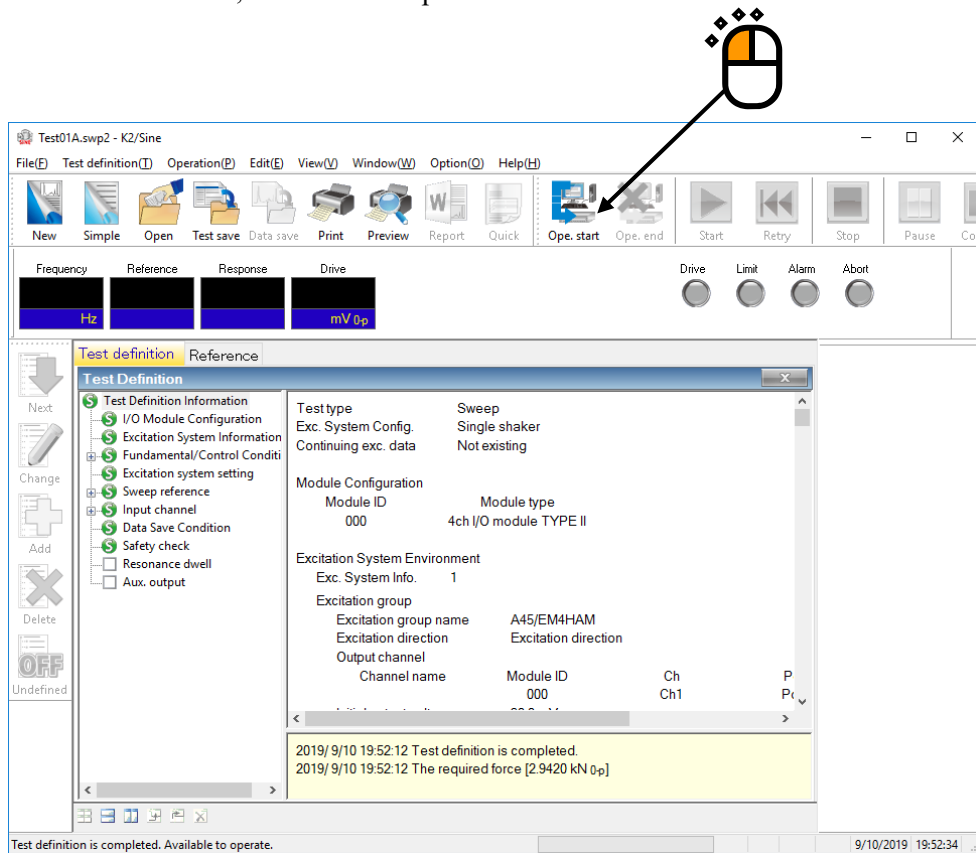

When any test likely to be related to military use is about to be started, an alert message appears.

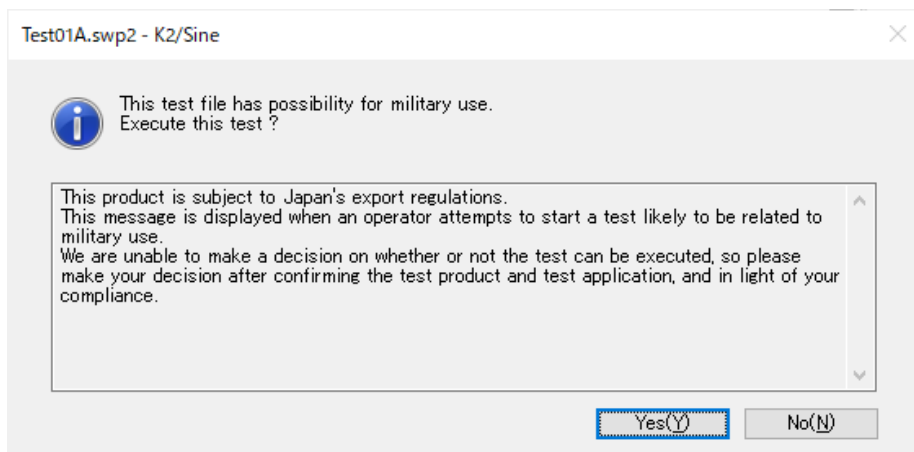

To start the test, select “Yes”.

The hardware is initialized and proceeded to the excitation start standby status.

If you do not implement any test, select “No”.

Then, the system returns to the status of the test definition completed.

# Chapter 10 Test Record

## 10.1 Outline

In the K2, results of the performed tests are recorded in the test history.

Information to be recorded in the test history is as shown below.

- (1) Begin Time: Time when excitation is started
- (2) End Time: Time when excitation is ended
- (3) Application: Name of application software such as SINE and RANDOM
- (4) Type: Type of tests such as SWEEP and SPOT
- (5) Name: Test file name
- (6) End Status: Status at the end time (Characters are indicated in red in case of abnormal end)
- (7) Test Time: Test time or number of excitation times (in the case of SHOCK)
- (8) Version: K2 software version
- (9) Caution: Result of judgement of intended use (for details, refer to Chapter 9)
- (10) Remarks: Reason for judgment of intended use (in the case of high and middle results)

When excitation is ended by each application software, the information is recorded in the test history.

Test Record Viewer displays the test history.

In each application software, data files are automatically saved after excitation is ended (\*1).

Test Record Viewer also displays these data files and the test definition files.

\*1 One thousand latest data files are saved in each application software.

The data capacity to be saved is limited to 1 GB. When the data capacity reaches the upper limit, data files are deleted in chronological order before the number of files reaches one thousand.

### <Securityfunction>

If you do not want to allow all operators to view the test history, use the security function. The security function checks password when Test Record Viewer is activated. If the input password is wrong, the function prevents Test Record Viewer from being activated.

In the default of the Test Record Viewer, the security function is valid.

As for the cancellation of the security function, refer to the section of “10.3.2 Security Setting”.

#### \* Password

We provide a password unique to each of customers. The password cannot be changed by customers themselves.

The password file “Password.txt” is saved in the license installer (Disc1).

The password is described in this file.

Pay close attention to the handling of the password.

## 10.2 Operation Example

### 10.2.1 Startup

<Operation example>

<Step 1>

Click on “TEST RECORD” icon of Launcher.

<Step 2>

The password input screen appears.

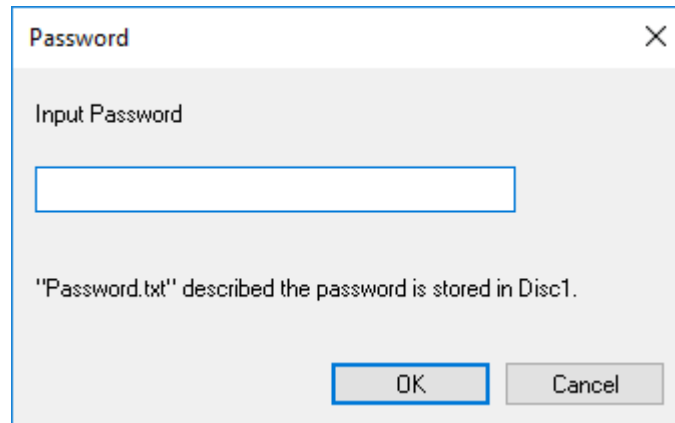

Input the password provided by us.

<Step 3>

When the input password is correct, Test Record Viewer is activated.

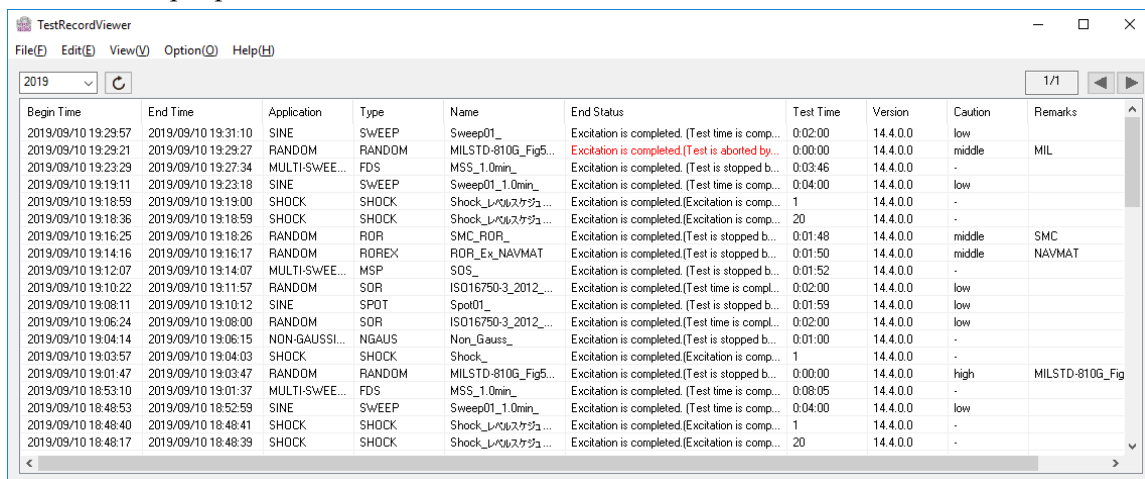

Begin Time	End Time	Application	Type	Name	End Status	Test Time	Version	Caution	Remarks
2019/09/10 19:29:57	2019/09/10 19:31:10	SINE	SWEEP	Sweep01_	Excitation is completed. (Test time is comp...	0:02:00	14.4.0.0	low	
2019/09/10 19:29:21	2019/09/10 19:29:27	RANDOM	RANDOM	MILSTD-810G_Fig5...	Excitation is completed. (Test is aborted by...	0:00:00	14.4.0.0	middle	MIL
2019/09/10 19:23:29	2019/09/10 19:27:34	MULTI-SWEE...	FDS	MSS_1.0min_	Excitation is completed. (Test is stopped b...	0:03:46	14.4.0.0	-	
2019/09/10 19:19:11	2019/09/10 19:23:18	SINE	SWEEP	Sweep01_1.0min	Excitation is completed. (Test time is comp...	0:04:00	14.4.0.0	low	
2019/09/10 19:18:59	2019/09/10 19:19:00	SHOCK	SHOCK	Shock_1.0minスケ...	Excitation is completed. (Excitation is comp...	1	14.4.0.0	-	
2019/09/10 19:18:36	2019/09/10 19:18:59	SHOCK	SHOCK	Shock_1.0minスケ...	Excitation is completed. (Excitation is comp...	20	14.4.0.0	-	
2019/09/10 19:16:25	2019/09/10 19:18:26	RANDOM	ROR	SMC_ROR_	Excitation is completed. (Test is stopped b...	0:01:48	14.4.0.0	middle	SMC
2019/09/10 19:14:16	2019/09/10 19:16:17	RANDOM	ROR	ROR_Ex_NAVMAT	Excitation is completed. (Test is stopped b...	0:01:50	14.4.0.0	middle	NAVMAT
2019/09/10 19:12:07	2019/09/10 19:14:07	MULTI-SWEE...	MSP	SOS_	Excitation is completed. (Test is stopped b...	0:01:52	14.4.0.0	-	
2019/09/10 19:10:22	2019/09/10 19:11:57	RANDOM	SOR	ISO16750-3_2012...	Excitation is completed. (Test time is compl...	0:02:00	14.4.0.0	low	
2019/09/10 19:08:11	2019/09/10 19:10:12	SINE	SPOT	Spot01_	Excitation is completed. (Test is stopped b...	0:01:59	14.4.0.0	low	
2019/09/10 19:06:24	2019/09/10 19:08:00	RANDOM	SOR	ISO16750-3_2012...	Excitation is completed. (Test time is compl...	0:02:00	14.4.0.0	low	
2019/09/10 19:04:14	2019/09/10 19:06:15	NON-GAUSSI...	NGAUS	Non_Gauss_	Excitation is completed. (Test is stopped b...	0:01:00	14.4.0.0	-	
2019/09/10 19:03:57	2019/09/10 19:04:03	SHOCK	SHOCK	Shock_	Excitation is completed. (Excitation is comp...	1	14.4.0.0	-	
2019/09/10 19:01:47	2019/09/10 19:03:47	RANDOM	RANDOM	MILSTD-810G_Fig5...	Excitation is completed. (Test is stopped b...	0:00:00	14.4.0.0	high	MILSTD-810G_Fig
2019/09/10 18:53:10	2019/09/10 19:01:37	MULTI-SWEE...	FDS	MSS_1.0min_	Excitation is completed. (Test time is comp...	0:08:05	14.4.0.0	-	
2019/09/10 18:48:53	2019/09/10 18:52:59	SINE	SWEEP	Sweep01_1.0min	Excitation is completed. (Test time is comp...	0:04:00	14.4.0.0	low	
2019/09/10 18:48:40	2019/09/10 18:48:41	SHOCK	SHOCK	Shock_1.0minスケ...	Excitation is completed. (Excitation is comp...	1	14.4.0.0	-	
2019/09/10 18:48:17	2019/09/10 18:48:39	SHOCK	SHOCK	Shock_1.0minスケ...	Excitation is completed. (Excitation is comp...	20	14.4.0.0	-	



## 10.2.2 Operation on Screen

<General operation on screen>

Year of history data to be displayed can be changed.

Information can be updated to the latest.

Displayed page can be changed.

Sorting with the title clicked is allowed.

Begin Time	End Time	Application	Type	Name	End Status	Test Time	Version	Caution	Remarks
2019/09/10 19:29:57	2019/09/10 19:31:10	SINE	SWEEP	Sweep01_	Excitation is completed. (Test time is comp...	0:02:00	14.4.0.0	low	
2019/09/10 19:29:21	2019/09/10 19:29:27	RANDOM	RANDOM	MILSTD-810G_Fig5...	Excitation is completed. (Test is aborted by...	0:00:00	14.4.0.0	middle	MIL
2019/09/10 19:23:29	2019/09/10 19:27:34	MULTI-SWEE...	FDS	MSS_1.0min_	Excitation is completed. (Test is stopped b...	0:03:46	14.4.0.0	-	
2019/09/10 19:19:11	2019/09/10 19:23:18	SINE	SWEEP	Sweep01_1.0min_	Excitation is completed. (Test time is comp...	0:04:00	14.4.0.0	low	
2019/09/10 19:18:59	2019/09/10 19:19:00	SHOCK	SHOCK	Shock_レバリスケジ...	Excitation is completed. (Excitation is comp...	1	14.4.0.0	-	
2019/09/10 19:18:36	2019/09/10 19:18:59	SHOCK	SHOCK	Shock_レバリスケジ...	Excitation is completed. (Excitation is comp...	20	14.4.0.0	-	
2019/09/10 19:16:25	2019/09/10 19:18:26	RANDOM	RDR	SMC_RDR_	Excitation is completed. (Test is stopped b...	0:01:48	14.4.0.0	middle	SMC
2019/09/10 19:14:16	2019/09/10 19:16:17	RANDOM	ROREX	RDR_Ex_NAVMAT	Excitation is completed. (Test is stopped b...	0:01:50	14.4.0.0	middle	NAVMAT
2019/09/10 19:12:07	2019/09/10 19:14:07	MULTI-SWEE...	MSP	SOS_	Excitation is completed. (Test is stopped b...	0:01:52	14.4.0.0	-	
2019/09/10 19:10:22	2019/09/10 19:11:57	RANDOM	SDR	ISO16750-3_2012_...	Excitation is completed. (Test time is compl...	0:02:00	14.4.0.0	low	
2019/09/10 19:08:11	2019/09/10 19:10:12	SINE	SPOT	Spot01_	Excitation is completed. (Test is stopped b...	0:01:59	14.4.0.0	low	
2019/09/10 19:06:24	2019/09/10 19:08:00	RANDOM	SDR	ISO16750-3_2012_...	Excitation is completed. (Test time is compl...	0:02:00	14.4.0.0	low	
2019/09/10 19:04:14	2019/09/10 19:06:15	NON-GAUSSI...	NGAUS	Non_Gauss_	Excitation is completed. (Test is stopped b...	0:01:00	14.4.0.0	-	
2019/09/10 19:03:57	2019/09/10 19:04:03	SHOCK	SHOCK	Shock_	Excitation is completed. (Excitation is comp...	1	14.4.0.0	-	
2019/09/10 19:01:47	2019/09/10 19:03:47	RANDOM	RANDOM	MILSTD-810G_Fig5...	Excitation is completed. (Test is stopped b...	0:00:00	14.4.0.0	high	MILSTD-810G_Fig
2019/09/10 18:53:10	2019/09/10 19:01:37	MULTI-SWEE...	FDS	MSS_1.0min_	Excitation is completed. (Test time is comp...	0:08:05	14.4.0.0	-	
2019/09/10 18:48:53	2019/09/10 18:52:59	SINE	SWEEP	Sweep01_1.0min_	Excitation is completed. (Test time is comp...	0:04:00	14.4.0.0	low	
2019/09/10 18:48:40	2019/09/10 18:48:41	SHOCK	SHOCK	Shock_レバリスケジ...	Excitation is completed. (Excitation is comp...	1	14.4.0.0	-	
2019/09/10 18:48:17	2019/09/10 18:48:39	SHOCK	SHOCK	Shock_レバリスケジ...	Excitation is completed. (Excitation is comp...	20	14.4.0.0	-	

<Menu for selection in list>

Select and right-click on one of the test results with a mouse. Then, the operation menu appears.

As for each operation menu, refer to “10.2.3 Other Operations”.

ion	Type	Name	End Status	Test Time
	SWEEP	Sweep01_	Excitation is completed. (Test time is comp...	0:02:00
M	RANDOM	MILSTD-8...	Excitation is completed. (Test is aborted by...	0:00:00
SWEE...	FDS	MSS_1.0...	Excitation is completed. (Test is stopped b...	0:03:46
	SWEEP	Sweep01_	Excitation is completed. (Test time is comp...	0:04:00
	SHOCK	S	s comp...	1
	SHOCK	S	s comp...	20
M	RDR	S	opped b...	0:01
M	ROREX	R	opped b...	0:01
SWEE...	MSP	SOS_	Excitation is completed. (Test is stopped b...	0:01
M	SDR	ISO16750...	Excitation is completed. (Test time is compl...	0:02:00

Open test definition file(T)  
Open graph data file(G)  
Save graph data file(S)

### 10.2.3 Other Operations

#### <Open test definition file>

The test definition file of the selected test (test results) can be opened with each application software.

Two types of operating methods are available.

- 1) Select and right-click on any item you want to display with a mouse. Then, the operation menu appears. In the displayed operation menu, select “Open test definition file”.
- 2) Select any item you want to display. In the menu bar, select “Edit”, then “Open test definition file”.

In either operating method, the menu becomes invalid when no applicable test definition file is found.

#### <Open graph data file>

The data file of the selected test (test results) can be displayed with DataViewer.

Three types of operating methods are available.

- 1) Select and right-click on any item you want to display with a mouse. Then, the operation menu appears. In the displayed operation menu, select “Open graph data file”.
- 2) Select any item you want to display. In the menu bar, select “Edit”, then “Open graph data file”.
- 3) Double-click on any item you want to display.

In the operating method described in 1) and 2) above, the menu becomes invalid when no applicable graph data file is found.

#### <Save graph data file>

The data file of the selected test (test results) can be saved.

Two types of operating methods are available.

- 1) Select and right-click on any item you want to display with a mouse. Then, the operation menu appears. In the displayed operation menu, select “Save graph data file”.
- 2) Select any item you want to display. In the menu bar, select “Edit”, then “Save graph data file”.

In either operating method, the menu becomes invalid when no applicable graph data file is found.

#### <Save CSV file>

The displayed test history can be saved in CSV file.

- 1) In the menu bar, select “File”, then “Save CSV file”.

## 10.3 Option

### 10.3.1 Set Up

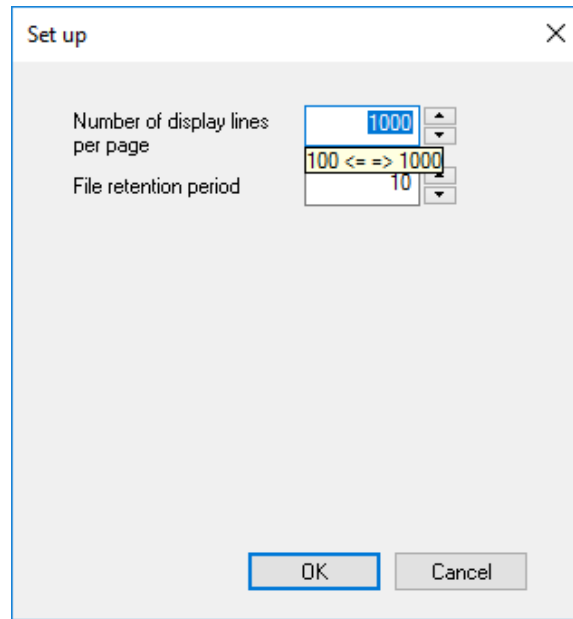

<Number of display lines per page>

The number of lines of test results to be displayed per page can be set up.

<File retention period>

The number of years for which test history is saved can be set.

For example, when the number of years is set to ten, the test results in the current year and the past ten years are saved.

### 10.3.2 SecuritySetting

Whether input password is checked or not at startup of the Test Record Viewer can be set.

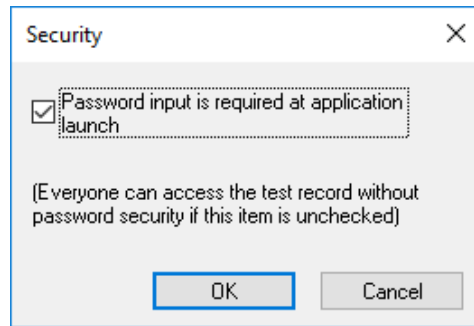

- To check input password at startup of Test Record Viewer
  - Tick the checkbox of “Password input is required at application launch”.
  - In the default setting, “Password input is performed”.
- When password check is not required at startup of Test Record Viewer
  - Untick the checkbox of “Password input is required at application launch”.
  - When the checkbox is unticked, the password input screen appears. When the input password is correct, Test Record Viewer can be started up without password input from the next time.
  - Note that all operators can view the test history in this case.

### 10.3.3 Selection of Column

Select any item to be displayed in the test history.

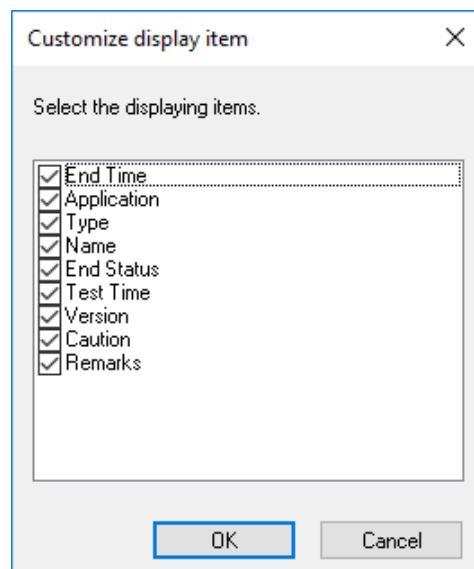

# INDEX

3	
3D graph	4-19, 6-1, 6-2, 6-6, 6-16
3D graph scale	4-27
A	
Applications mode	7-1, 7-3
Armature mass	3-4
Aux. information	4-37
C	
Ch	3-2
Change Graph Color	4-36
Change of auxiliary information	4-37
Color map	4-19, 6-2, 6-6, 6-19
Computer	1-1
Condition Check	8-1
Contact I/O Information	3-3, 4-60
Control Frequency Range	3-3
Cursor	4-28
Cursor in 3D graph	4-33
Customizing toolbar buttons	4-91
D	
Dedicated Hardware	1-3, 1-9
Deletion of registered standards	7-19
Display config	6-22
Display Q value	4-38
Double cursor display	4-29
E	
ECO-option	5-1
E-Mail Sending Function	4-72
Emergency Stop Input Contacts	1-7
Environment setting	4-58, 4-59, 4-61
Excitation system information	4-53, 4-57, 4-61
F	
File Conversion	4-48
File conversion to CSV	4-48
Finding of standards	7-21
G	
Graph Change	4-34
Graph color	4-36, 4-46

Graph display on Excel.....	4-51
<b>H</b>	
Header and Footer.....	4-43, 4-45
<b>I</b>	
I/O Module Configuration.....	3-1
I/O Module Configuration change.....	3-1
Input enviroment information.....	4-53, 4-58, 4-59
Input Type.....	3-6
Installation of software.....	2-2
IT Function.....	4-69
<b>K</b>	
K2 PCI Express I/F Board.....	1-11, 2-1, 2-2
<b>L</b>	
Launcher.....	4-2, 4-3, 7-1
Live Data in Operation.....	4-53, 4-54
Load from system model.....	3-3
<b>M</b>	
Manual.....	4-15
Mark the cursor data.....	4-32
Module ID.....	3-2, 3-6
<b>O</b>	
Operation mode.....	4-14, 4-67
OS.....	1-12
Other Control Quantities.....	3-3
Overlaid graph.....	6-22
Overlaid graph of two types of data.....	4-39
<b>P</b>	
Page.....	4-10
Page setup.....	4-45
Palette.....	4-12, 4-13
Password.....	10-1
Peak Mark.....	4-35, 4-38
Peak search.....	4-30
Polarity.....	2-3, 3-2, 3-7
Print.....	4-36, 4-42, 4-46
Print per graph.....	4-43, 4-45
Printer.....	4-36, 4-44, 4-47
<b>Q</b>	
Quick Report.....	4-87

## R

Rating Information .....	3-1, 3-3
Registration and Deletion of Standard Items .....	7-16
Registration of cursor data .....	4-31
Registration of Test Files as Standards .....	7-16
Report Generator .....	4-76, 4-85, 4-86

## S

Save the cursor data .....	4-31
Scale .....	1-8, 4-25
Search in the scale range .....	4-38
Security .....	10-1, 10-6
Selecting languages .....	4-52
Sensitivity .....	3-6
Set Up .....	2-1, 4-14
Standards mode .....	7-1, 7-6
Startup and Stopping of system .....	2-5

## T

TEDS .....	3-5
Test beginning/ending time .....	4-37
Test Definition File .....	4-9, 4-53, 4-56
Test files mode .....	7-1, 7-11
Test Record .....	10-1
Threshold of peak detection .....	4-38
Transmissibility display unit .....	6-21

## W

Waiting for stabilization of IEPE sensor .....	4-90
Waterfall graph .....	6-2, 6-6, 6-19
Waterfall graph(depth fixing) .....	4-19
Waterfall graph(scroll display) .....	4-19, 4-22, 4-27
Web Monitor .....	4-69